



Diagnostic

McIntosh

0-001

Conventional laryngoscope set with medium handle
Set of 3, Fig. 1-Fig. 3

0-002

Conventional laryngoscope set with medium handle
Set of 4, Fig. 1-Fig. 4

0-003

Fiber optic laryngoscope set with medium handle
Set of 3, Fig. 1-Fig. 3

0-004

Fiber optic laryngoscope set with medium handle
Set of 4, Fig. 1-Fig. 4

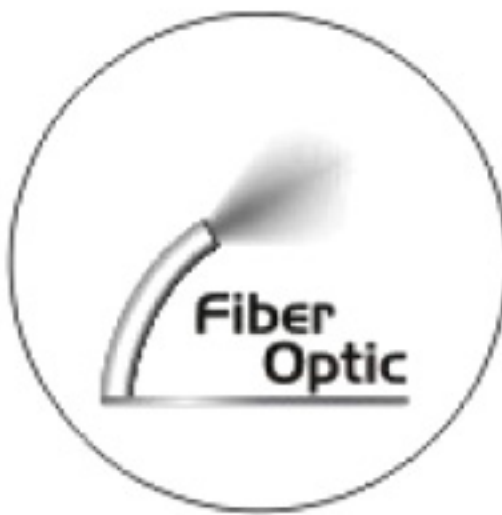

Miller

0-005

Conventional Laryngoscope set with medium handle
Set of 3, fig. 1-fig. 3

0-006

Conventional Laryngoscope set with medium handle
Set of 4, fig. 1-fig. 4

0-007

Fiber optic laryngoscope set with medium handle
Set of 3, fig. 1-fig. 3

0-008

Fiber optic laryngoscope set with medium handle
Set of 4, fig. 1-fig. 4





Diagnostic



0-009
McIntosh
Laryngoscopes
(DISPOSABLE)
Available
Size 0,1,2,3,4



McIntosh
0-016
Laryngoscopes
Battery Handle
(without battery)
Available
Size 0,1,2,3,4

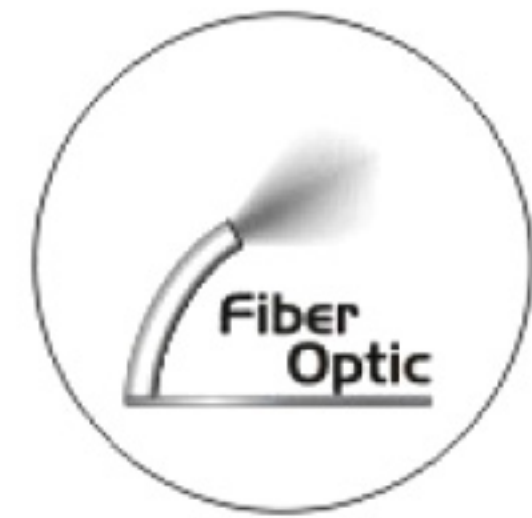

Fig. 0
0-010
Conventional
0-011
Fiber optic
Working length 55 mm



Fig. 1
0-012
Conventional
0-013
Fiber optic
Working length 80 mm



Miller-Baby
0-014
Conventional laryngoscope set with medium handle
Set of 2, Fig. 0-Fig. 1
0-015
Fiber optic laryngoscope set with medium handle
Set of 2, Fig. 0-Fig. 1



GERMAN PROFILE F/O BLADES

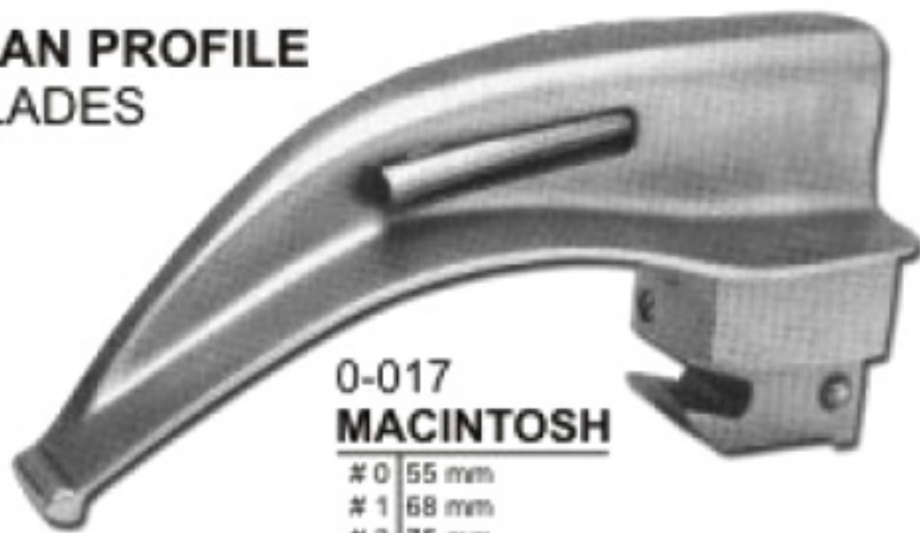

**0-017
MACINTOSH**
0 55 mm
1 68 mm
2 75 mm
3 115 mm
4 130 mm

0-018 MOONLIGHT

0 55 mm
1 70 mm
2 90 mm
3 115 mm
4 132 mm



**0-020
MILLER**
0 55 mm
1 76 mm
2 130 mm
3 170 mm
4 180 mm



**0-021
FOREGGER**
0 55 mm
1 68 mm
2 90 mm
3 110 mm
4 132 mm

ENGLISH PROFILE F/O BLADES



**0-023
FOREGGER**
0 55 mm
1 68 mm
2 90 mm
3 110 mm
4 132 mm



**0-022
MILLER**
0 55 mm
1 76 mm
2 130 mm
3 170 mm
4 180 mm



**0-024
MACINTOSH**
0 55 mm
1 68 mm
2 75 mm
3 115 mm
4 130 mm

Diagnostic

LARYNGOSCOPES

Fiber optic



0-019



Diagnostic



0-025
OTOSCOPE (without battery)
with halogen lamp
or
fiber optic



0-026
OPHTHALMOSCOPE SET
Consisting of :
Ophthalmoscope,
Battery Handle
(without battery)



(Available in different colours)
with halogen lamp or fiber optic

0-027
MINI OTOSCOPE
with 8 Ear specula
in pouch

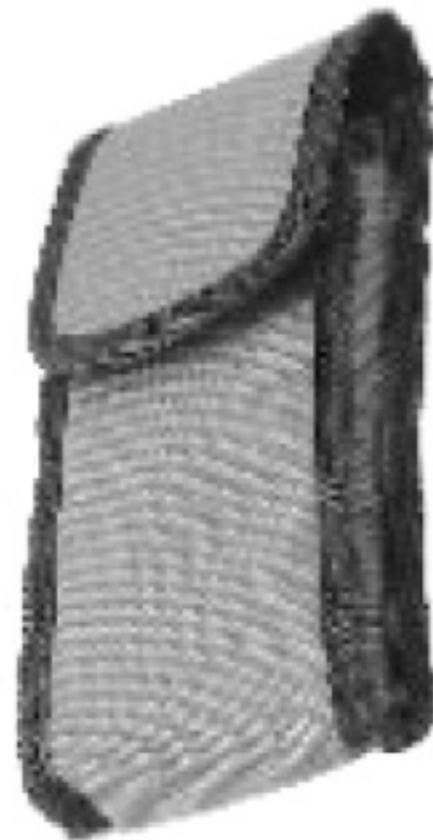

0-028
DIAGNOSTICS ENT SET
Consisting of :
Otoscope With 2 Specula
Nasal Specula, Lamp Carrier
Tongue Depressor, 2 Laryngeal Mirrors,
Vertical Ophthalmoscope,
Battery Handle (without Battery)



DIAGNOSTICS

DIAGNOSTICS SETS



**DIAGNOSTIC SET
(ENT COMPLETE)
1-100**

Consisting of Battery Handle (without Battery)
3 Ear Specula, 1 Nasel Specula,
2 Laryngeal mirrors with Holder
1 Tongue Depressor Holder, 1 Bulb



**OTOSCOPE Set
1-110**

Consisting of Battery Handle
(without Battery) 3 Ear Specula, 1 Bulb

BLOOD LANCETS



**FRANCKE
1-120**



**FRANCKE
1-130**

CHEST PIECES



**BOWLES
1-140**





DIAGNOSTICS

CHEST PIECES & STETHOSCOPES

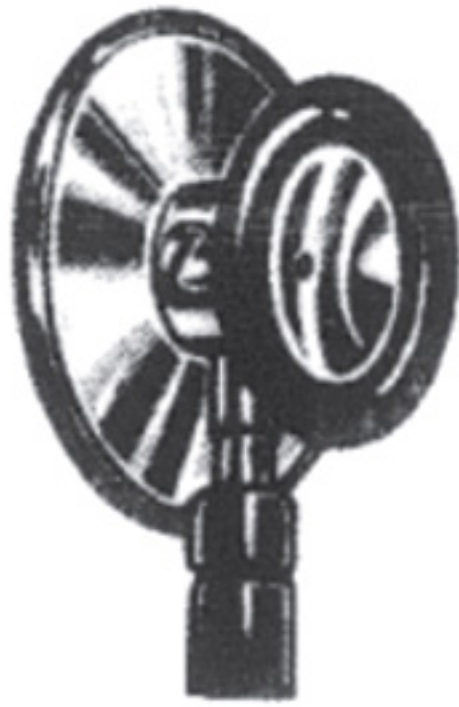

LIGHT WEIGHT
1-160



SPRAGUE-BOWLES
1-170



BOWLES
1-180



FORD
1-190



BELL-END
1-200



SPARE RUBBER
1-210



DIAPHRAM
1-220

FRAMES



HEAD FRAME
(FOR LIGHTWEIGHT)
1-230



HEAD FRAME
(FOR BINURAL)
1-240



PINARD
1-250 ALUMINIUM
1-260 WOODEN



DIAGNOSTICS

STETHSCOPES



BOWLES
1-270



FORD
1-280



FORD-BOWLES
1-290

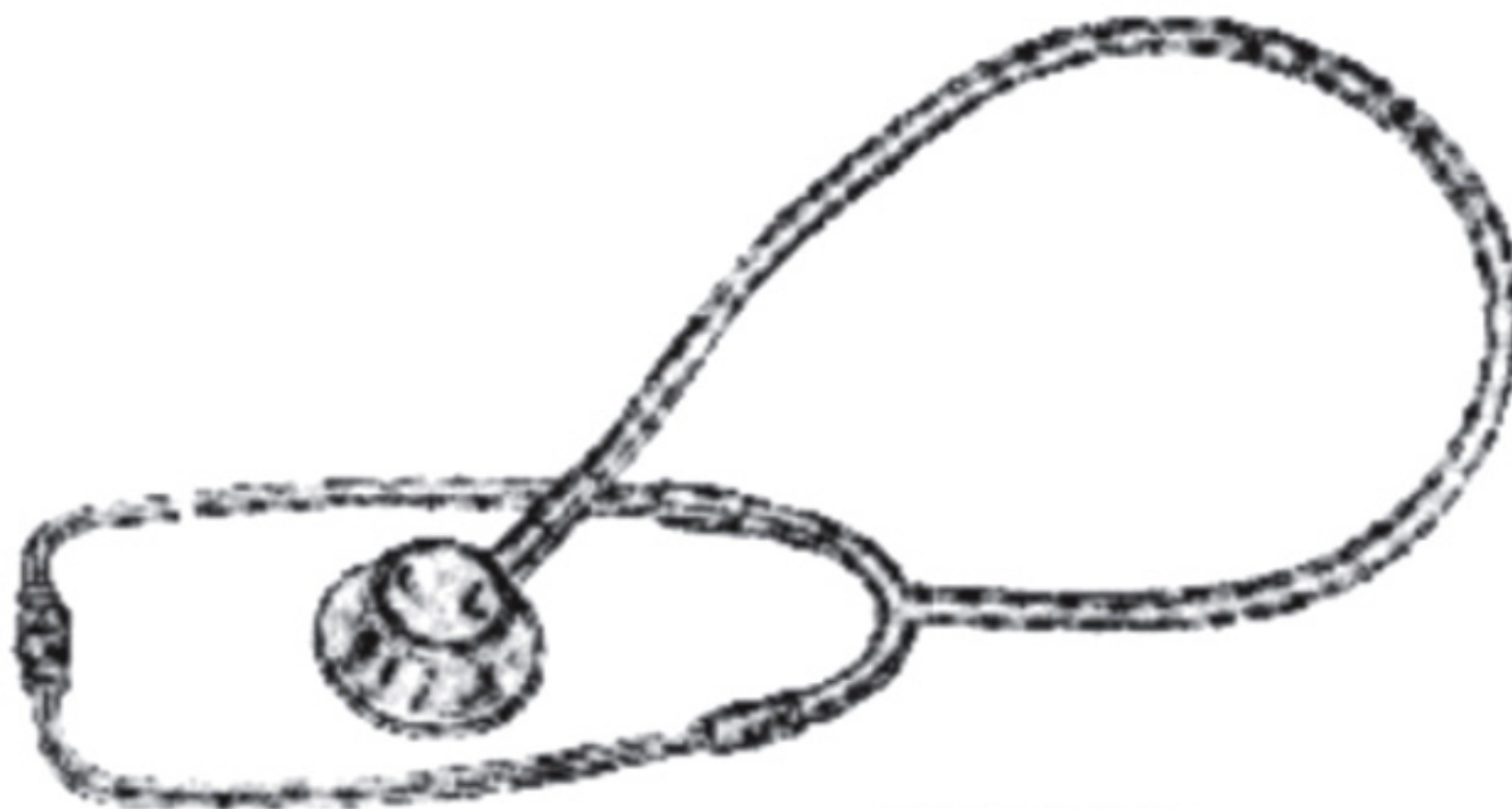

LIGHTWEIGHT
1-300



DIAGNOSTICS

PERCUSSION HAMMERS



TAYLOR
1-310 19cm



DEJERINE
1-320 20cm



DEJERINE
1-330



BABINSKY
1-340



BUCK
1-350 18cm



BERLINER
1-360



TRAUBE
1-370



PINWHEEL

WARTENBERG
1-380



ANAESTHESIA

INHALERS



SCHIMMELBUSCH
3-100 ADULT
3-102 CHILD

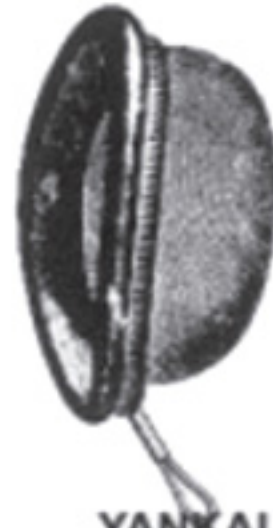

YANKAUER
3-120 ADULT
3-122 CHILD

AIRWAYS



CONNELL
3-130 ADULT
3-132 CHILD

CATHETER INTRODUCING FORCEPS



MAGILL
3-140 24cm
3-142 20cm

LARYNGOSCOPES



McINTOSH
3-150

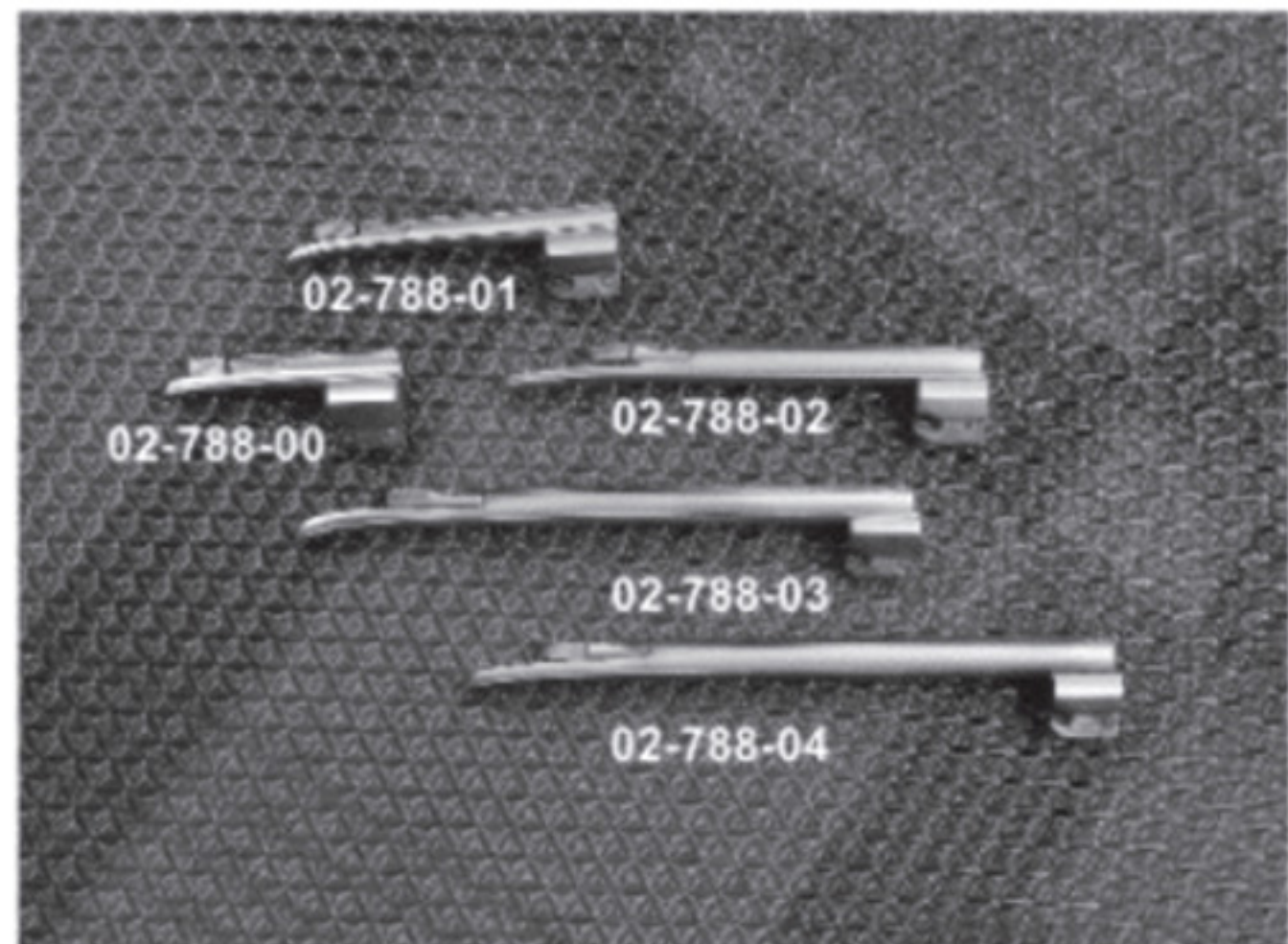

Miller



PUNCTURE TROCARS ABDOMINAL

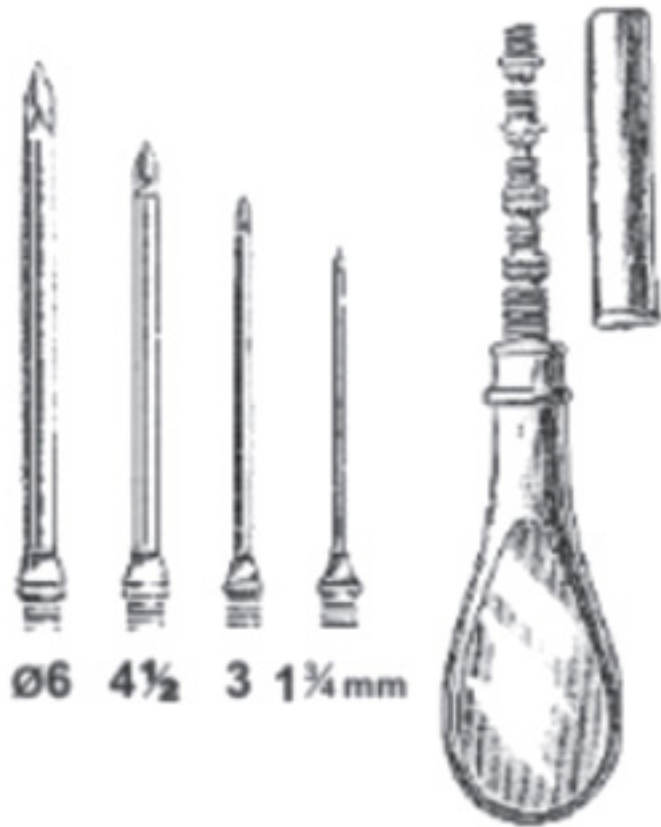

Ø6 4½ 3 1¼mm

UNIVERSAL
5-100 SET OF 4



UNIVERSAL
5-100 SET OF 3

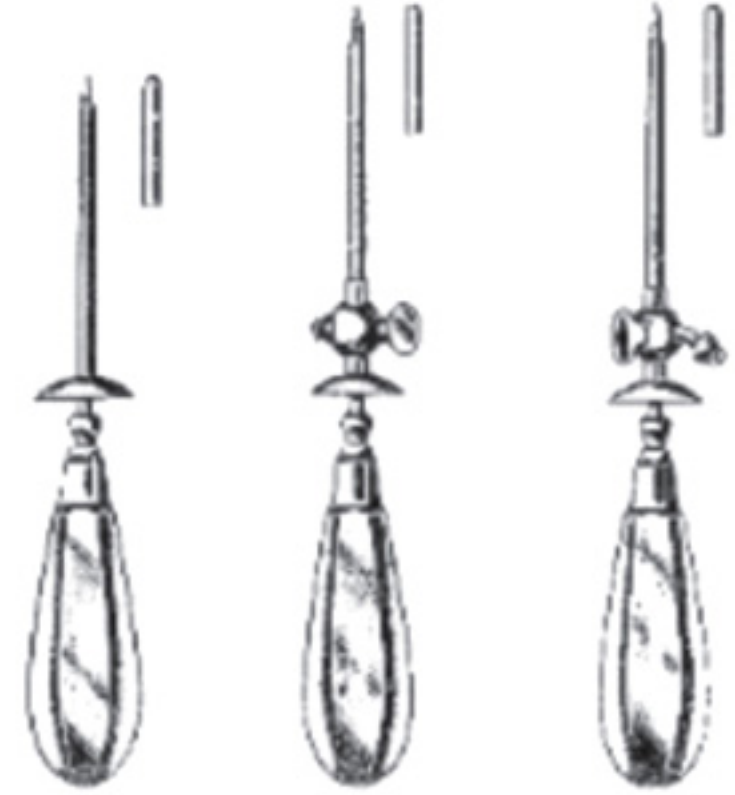

ABDOMINAL

- | | | |
|---------------|--------------|-------|
| 5-120 3 mmØ | 5-130 3 mmØ | 5-140 |
| 5-121 3.5 mmØ | 5-131 3.5mmØ | 5-141 |
| 5-122 4 mmØ | 5-132 4 mmØ | 5-142 |
| 5-123 4.5mmØ | 5-133 4.5mmØ | 5-143 |
| 5-124 5 mmØ | 5-134 5 mmØ | 5-144 |
| 5-125 5.5mmØ | 5-135 5.5mmØ | 5-145 |
| 5-126 6 mmØ | 5-136 6 mmØ | 5-146 |



NELSON
5-150 25 Fg.
5-152 30 Fg.
5-154 33 Fg.
5-156 35 Fg.



FLEURANT
5-160



FLEURANT
5-170



HYDROCELE
5-180 8Fg.
5-182 9fg.
5-184 10Fg.



ACITES
5-190 16 Fg.
5-192 21 Fg.



PUNCTURE TROCARS ABDOMINAL



KRAUSE
5-200 5.5mm



LICHTWITZ
5-210 1.75mm



OCHSNER
5-220 10Fg.
5-221 12Fg.
5-222 14Fg.
5-223 16Fg.
5-224 18Fg.
5-225 20Fg.

ASPIRATION SUCTION TUBES



POOLE
5-230 30 Fg.



POOLE
5-240 30 Fg.



YANKAUER
5-250



GENERAL INSTRUMENTS

HANDLES

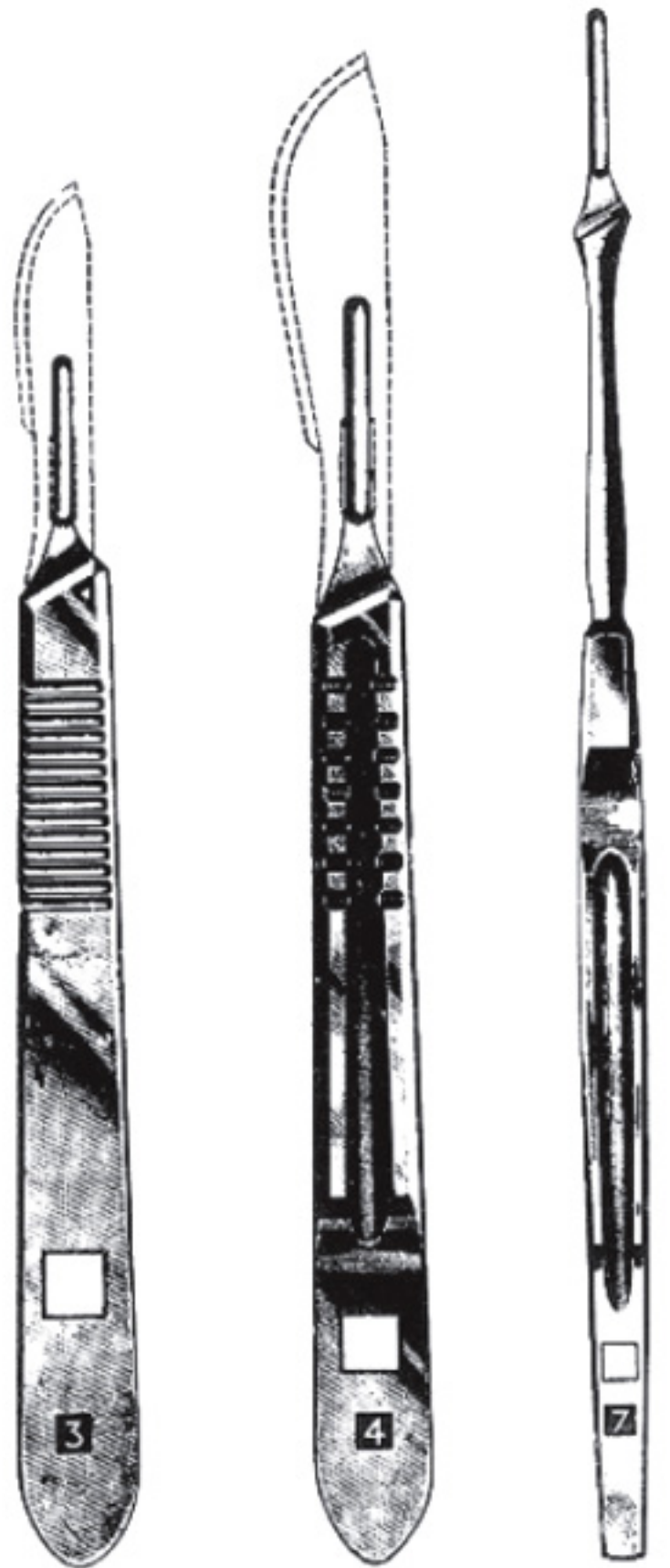

7-103

7-104

7-107

SCALPELS

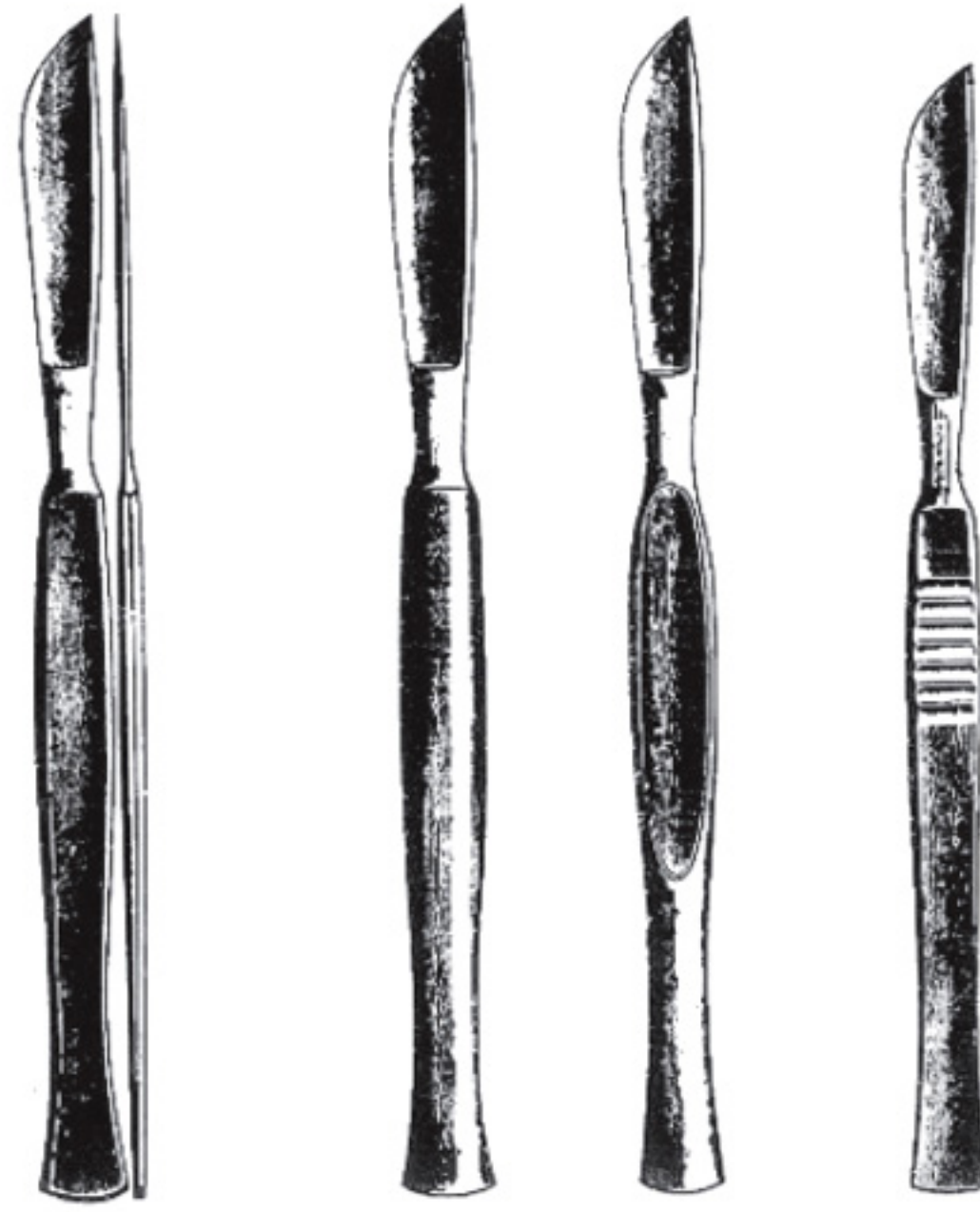

7-110
Fig. 1 to 18

7-120
Fig. 1 to 18

7-130
Fig. 1 to 18

7-140
Fig. 1 to 18



7-150
Fig. 1 to 18



GENERAL INSTRUMENTS SCALPELS

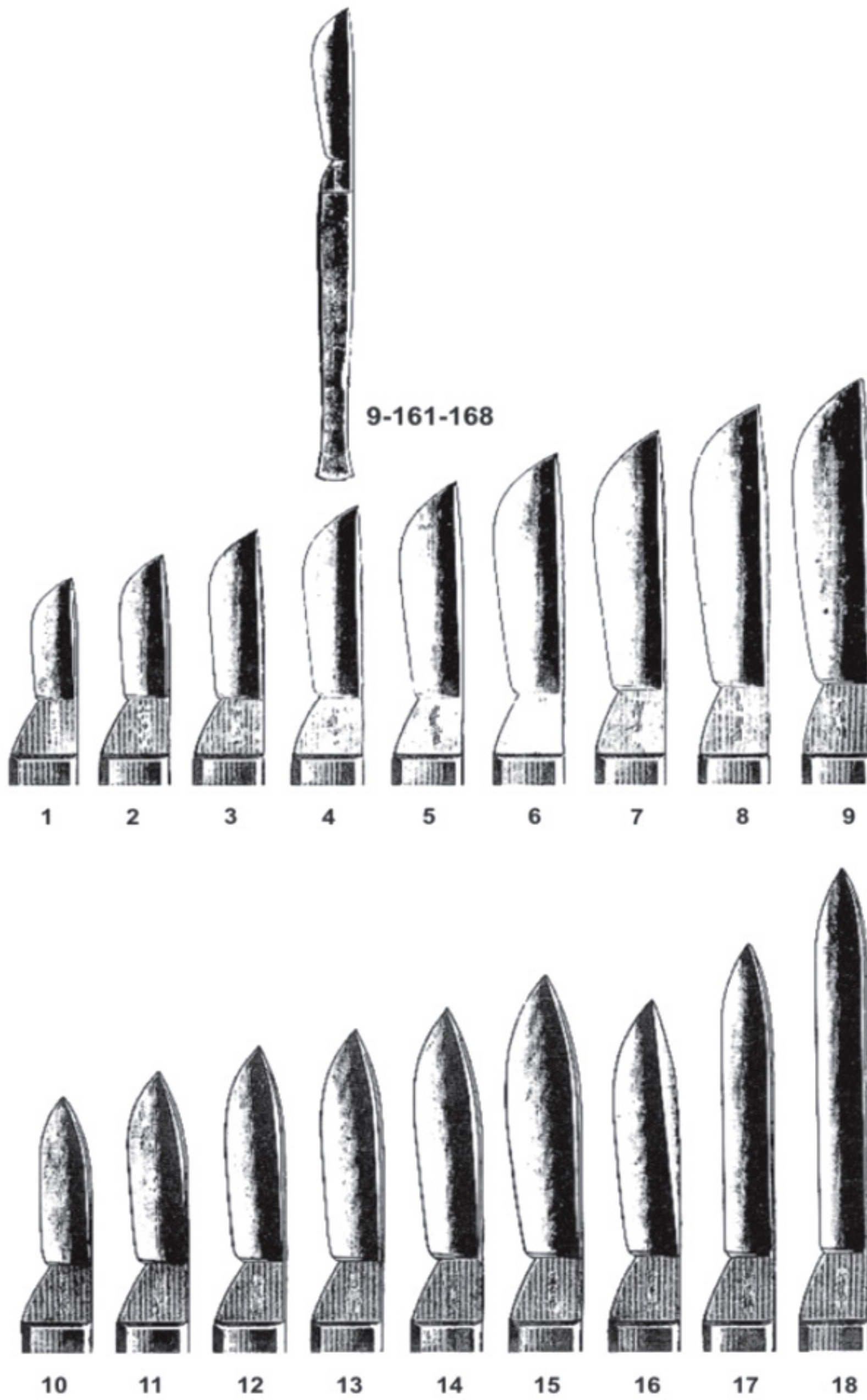



GENERAL INSTRUMENTS

SCALPELS

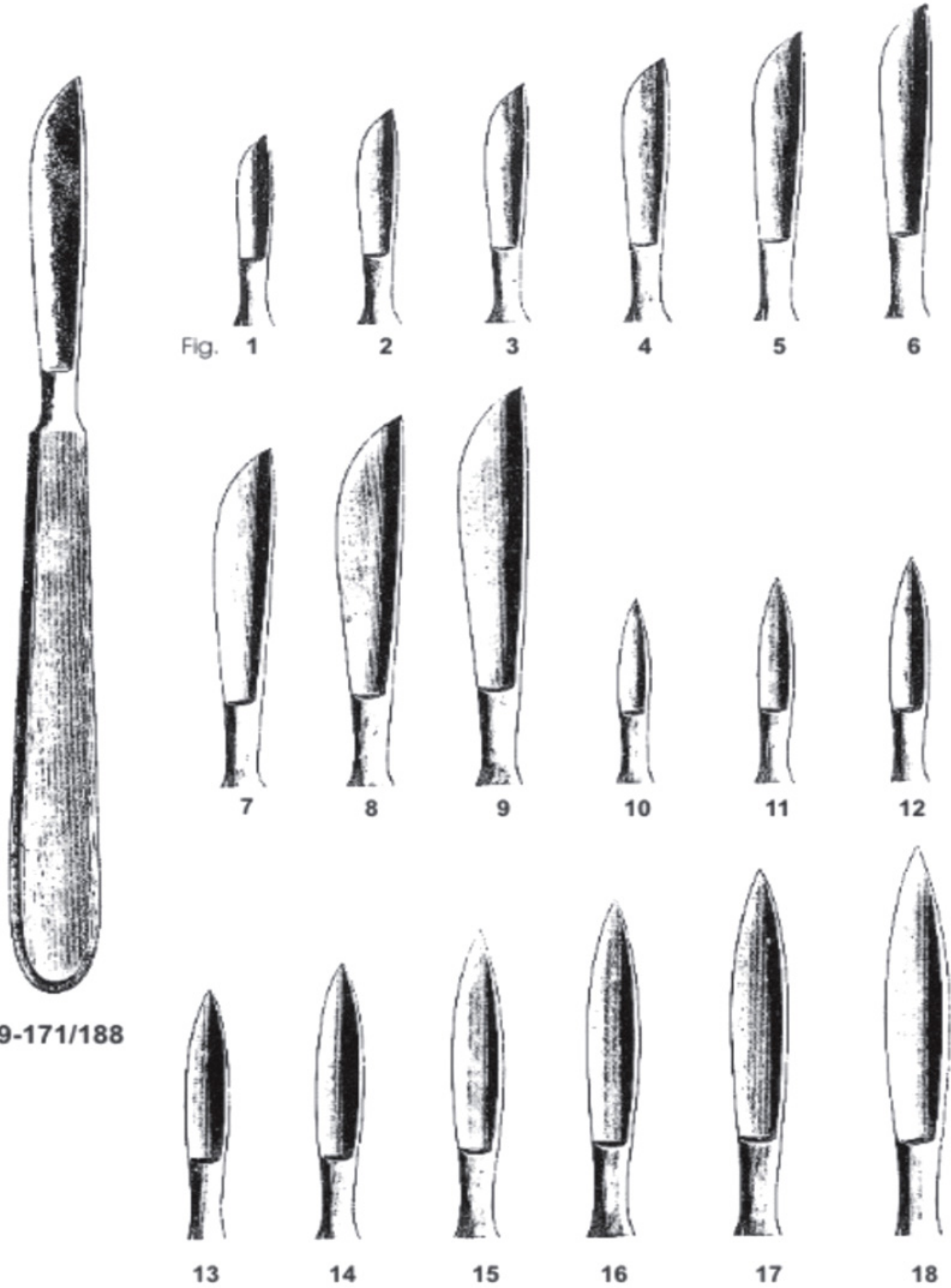



GENERAL INSTRUMENTS KNIVES



LANGENBECK AMPUTATION
9-190 Blade 12cm



LISTON AMPUTATION
9-200 Blade 17, 20cm



AMPUTATION
9-210
Blade 13, 16, 19, 22cm



CALTIN
9-220
Blade 16, 19, 22cm



BRAIN
9-230
Blade 20, 22cm

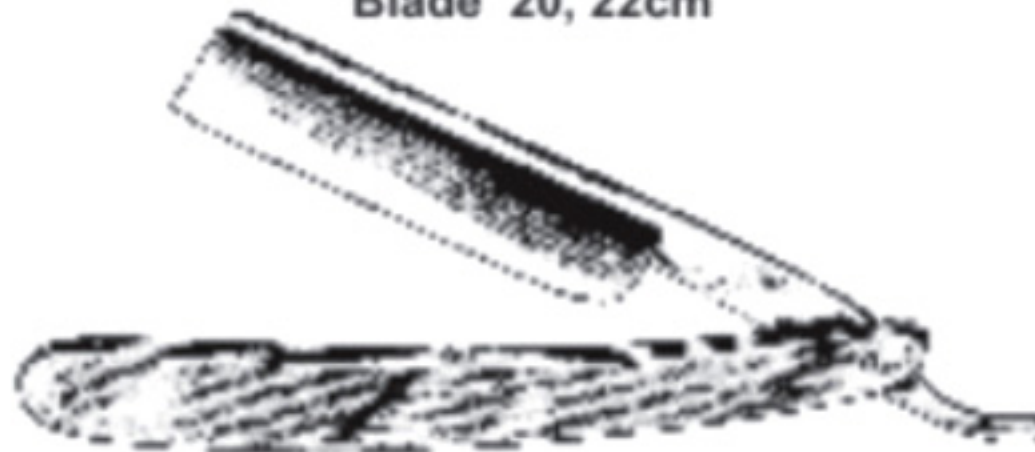

RAZOR
9-240



GENERAL INSTRUMENTS

DISSECTING SETS

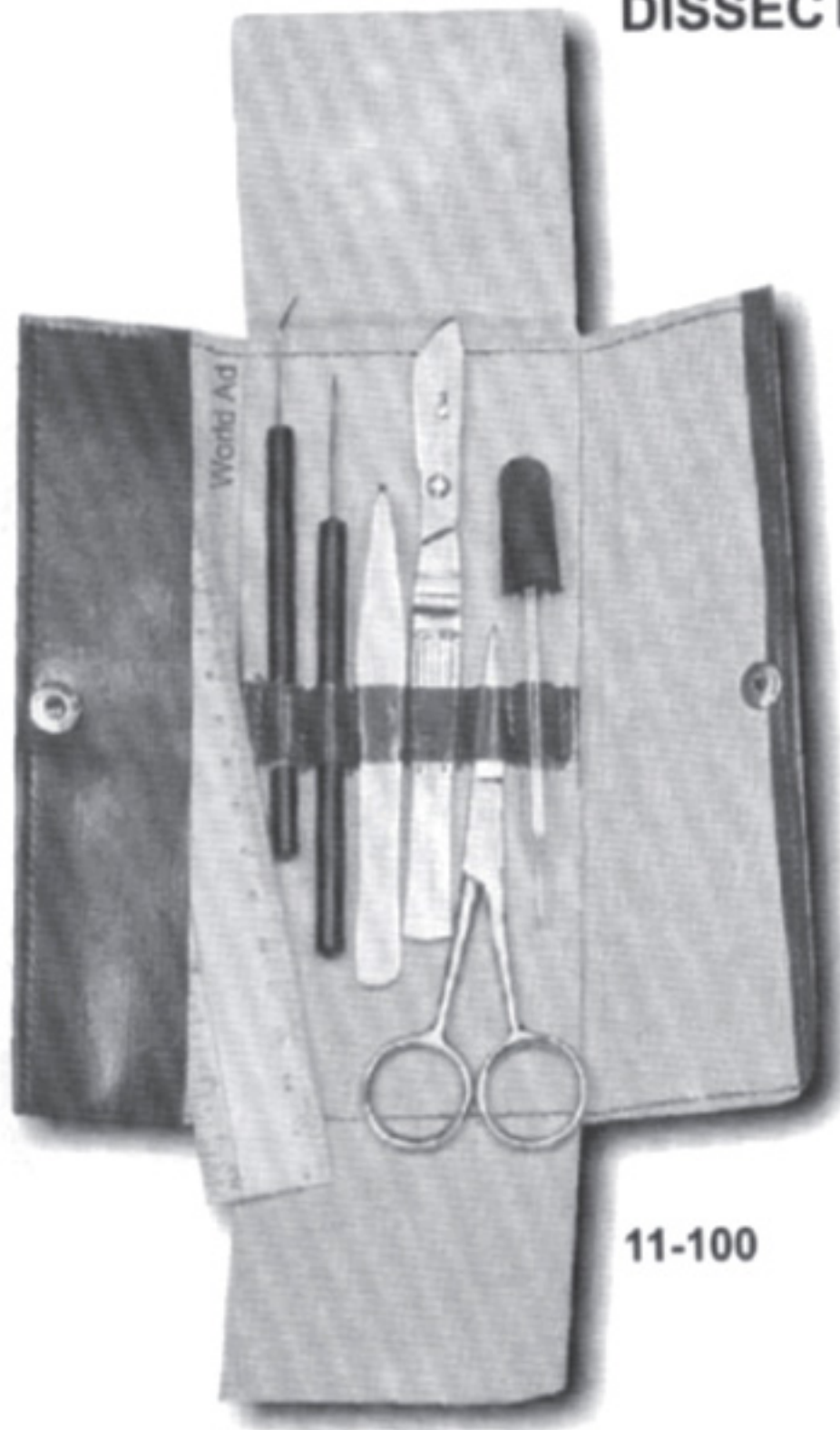

11-100

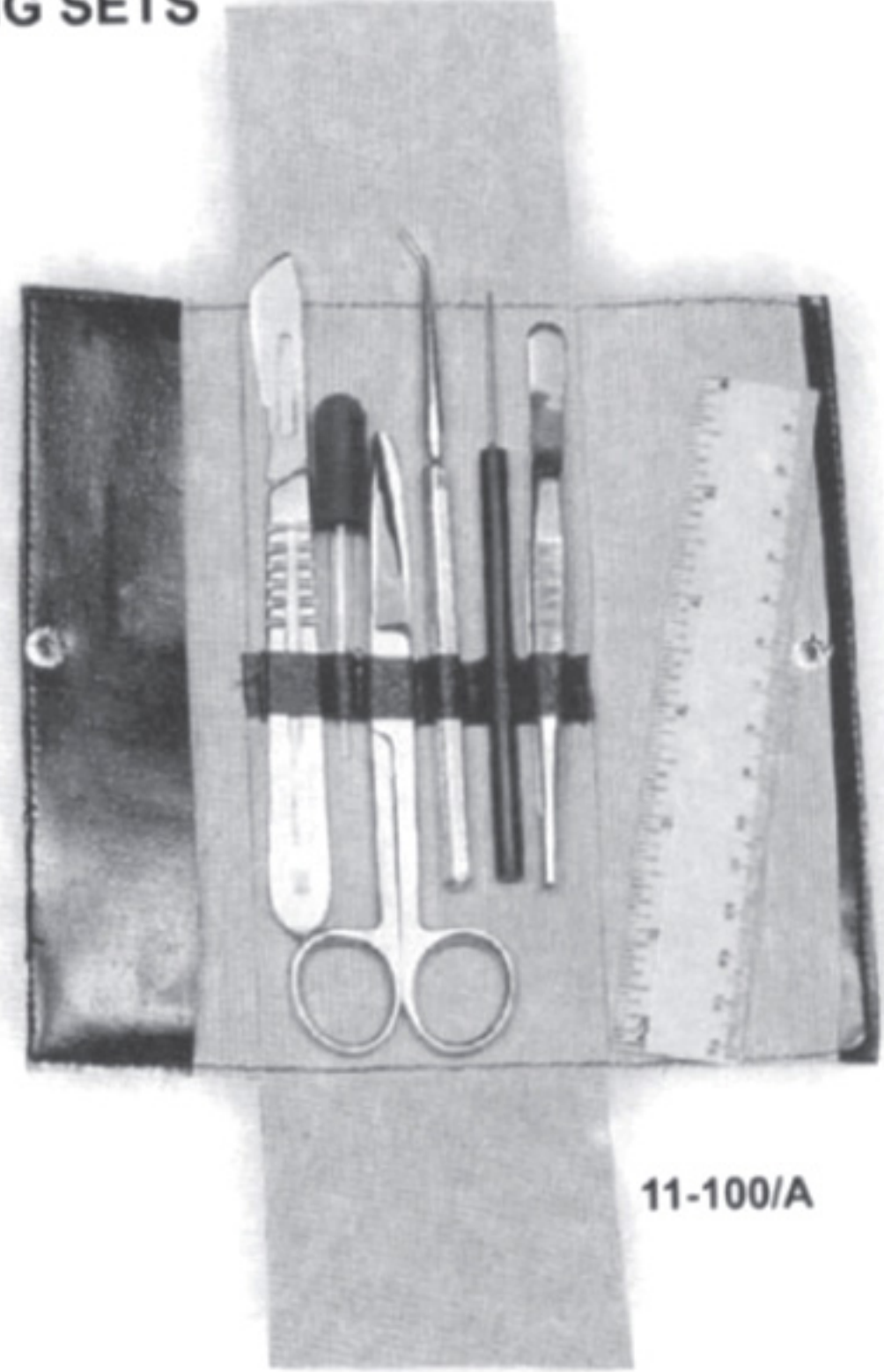

11-100/A

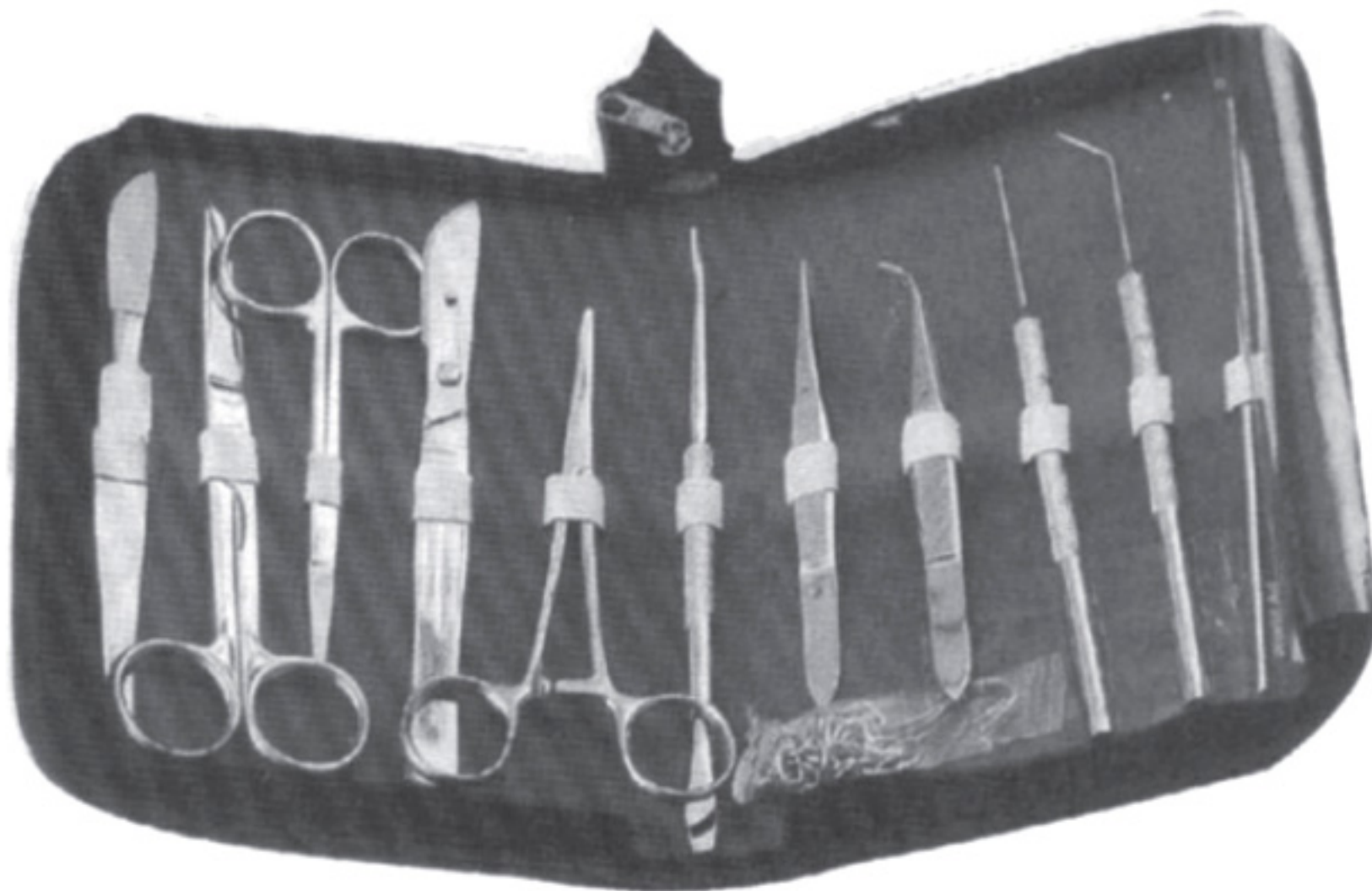

11-120



GENERAL INSTRUMENTS OPERATING SCISSORS



OPERATING

13-100	13cm	13-110	13cm	13-120	13-130	13cm	13-140	13cm	13-150
13-102	14cm	13-112	14cm	13-122	13-132	14cm	13-142	14cm	13-152
13-104	15cm	13-114	15cm	13-124	13-134	15cm	13-144	15cm	13-154
13-106	17.5cm	13-116	17.5cm	13-126	13-136	17.5cm	13-146	17.5cm	13-156
13-108	20cm	13-118	20cm	13-128	13-138	20cm	13-148	20cm	13-158



INCISION
13-160 13cm
13-162 14cm



DEAVER
13-170 14cm



13-172 14cm



MAYO
13-180 14cm
13-182 15cm
13-184 17cm
13-186 23cm



13-190 14cm
13-192 15cm
13-194 17cm
13-196 23cm

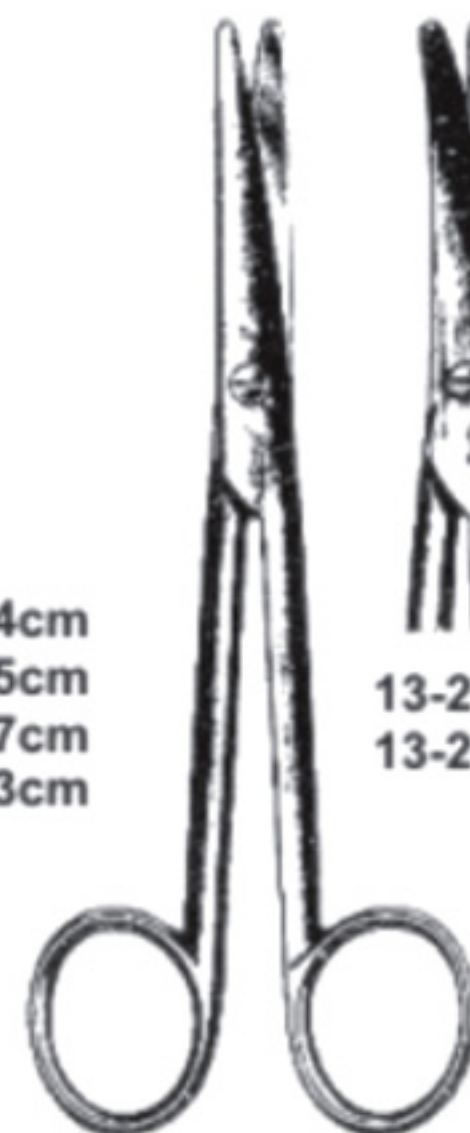

MAYO STILLE
13-200 15cm
13-202 17cm



13-210 15cm
13-212 17cm



GENERAL INSTRUMENTS OPERATING SCISSORS



LEXER
13-220 16cm



LEXER
13-222 16cm



METZENBAUM
13-230 14cm



13-232 14cm



METZENBAUM-NELSON
13-240 18cm
13-242 20cm
13-244 23cm
13-246 25cm
13-248 28cm



13-250 18cm
13-252 20cm
13-254 23cm
13-256 25cm
13-258 28cm

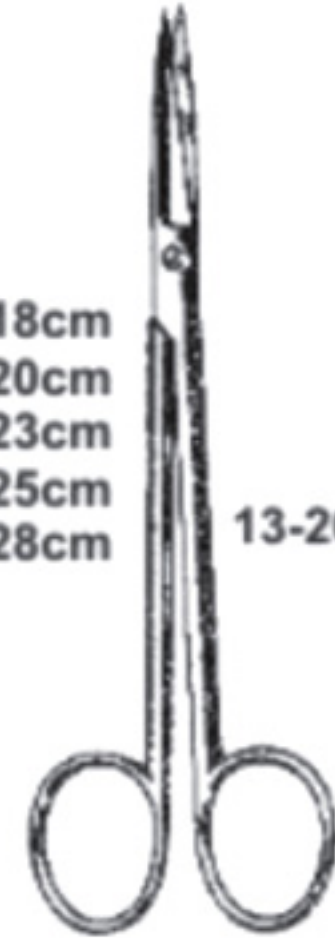

METZENBAUM
13-260 14cm



13-262 14cm

PLASTIC SURGERY SCISSORS



KILNER
13-270 12cm

NEURO SCISSORS



McINDOE
13-280 22cm

TONSIL SCISSORS



STRULLY
13-290 19cm



GENERAL INSTRUMENTS

TONSIL SCISSORS



YANKAUER
13-300 17.5cm



DEAN
13-310 17cm

NAZAL SCISSORS



HEYMAN
13-320 18cm

NAZAL SCISSORS



BECKMANN
13-330 19cm

LIGATURE SCISSORS



SPENCER
13-340 9cm

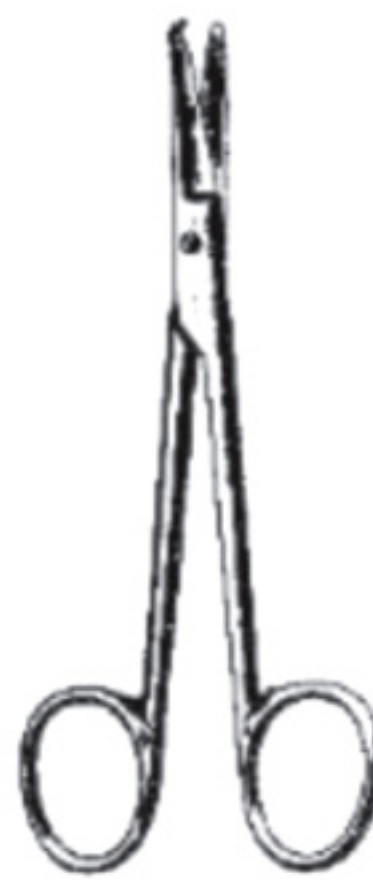

SPENCER
13-350 13cm



SPENCER
13-360 14cm



GENERAL INSTRUMENTS

LIGATURE & WIRE SCISSORS



HEATH
13-370 15cm



UNIVERSAL
13-380 12cm



SCHOEMAKER
13-390 14.5cm

UMBILICAL SCISSORS

EPISITOMY SCISSORS



BRAUN-STADLER
13-400 14.5cm
13-402 22 cm



BUSCH
13-410 16cm



BUSCH
13-420 16cm



U.S.A. PATT.
13-430 10.5cm
13-432 12.5cm



GENERAL INSTRUMENTS

DISSECTING SCISSORS

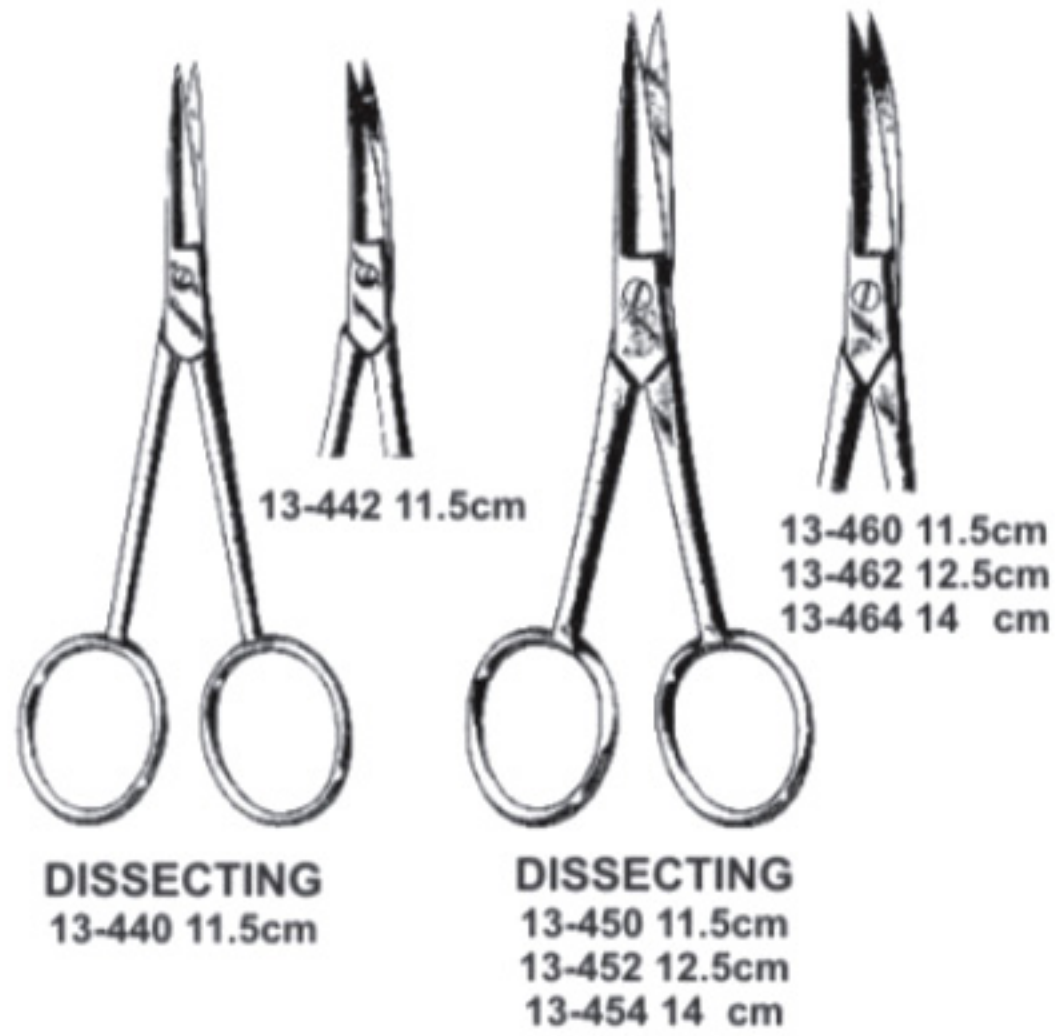

UTERINE SCISSORS

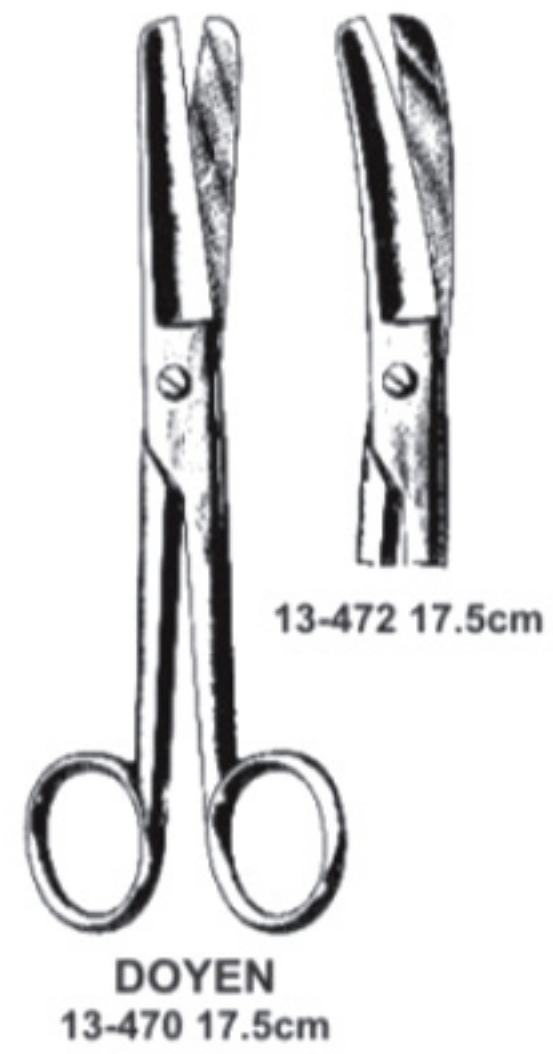

UTERINE SCISSORS

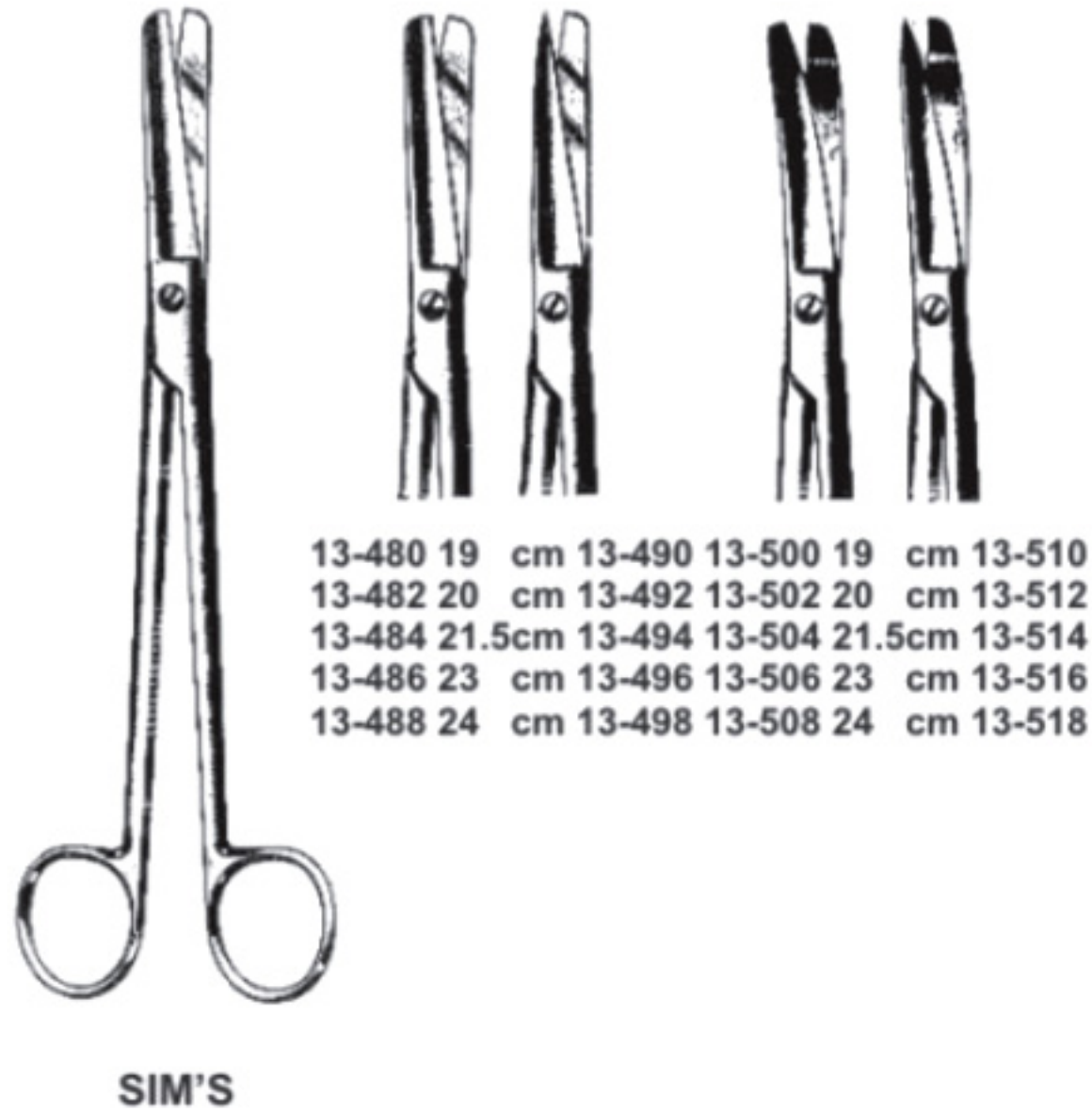

FISTULA SCISSORS

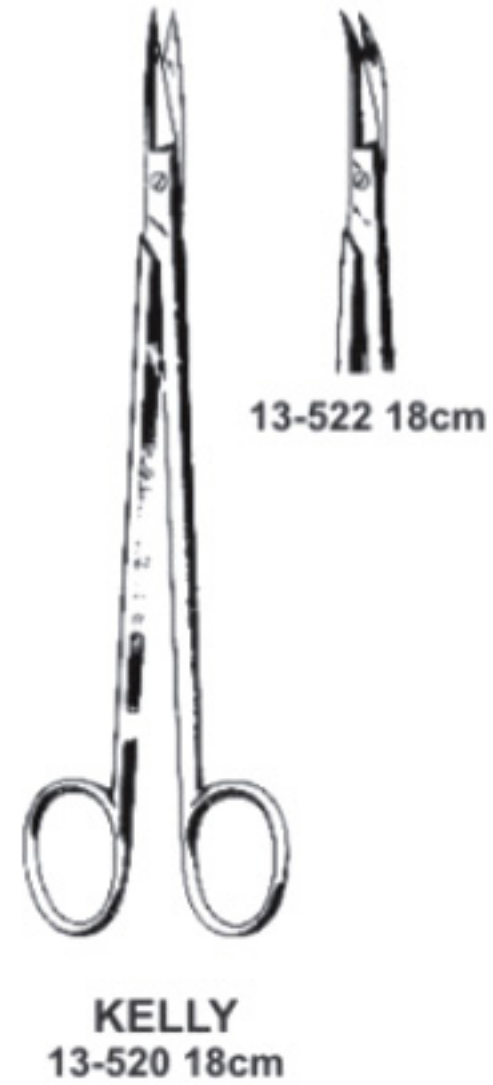



GENERAL INSTRUMENTS

EYE SCISSORS

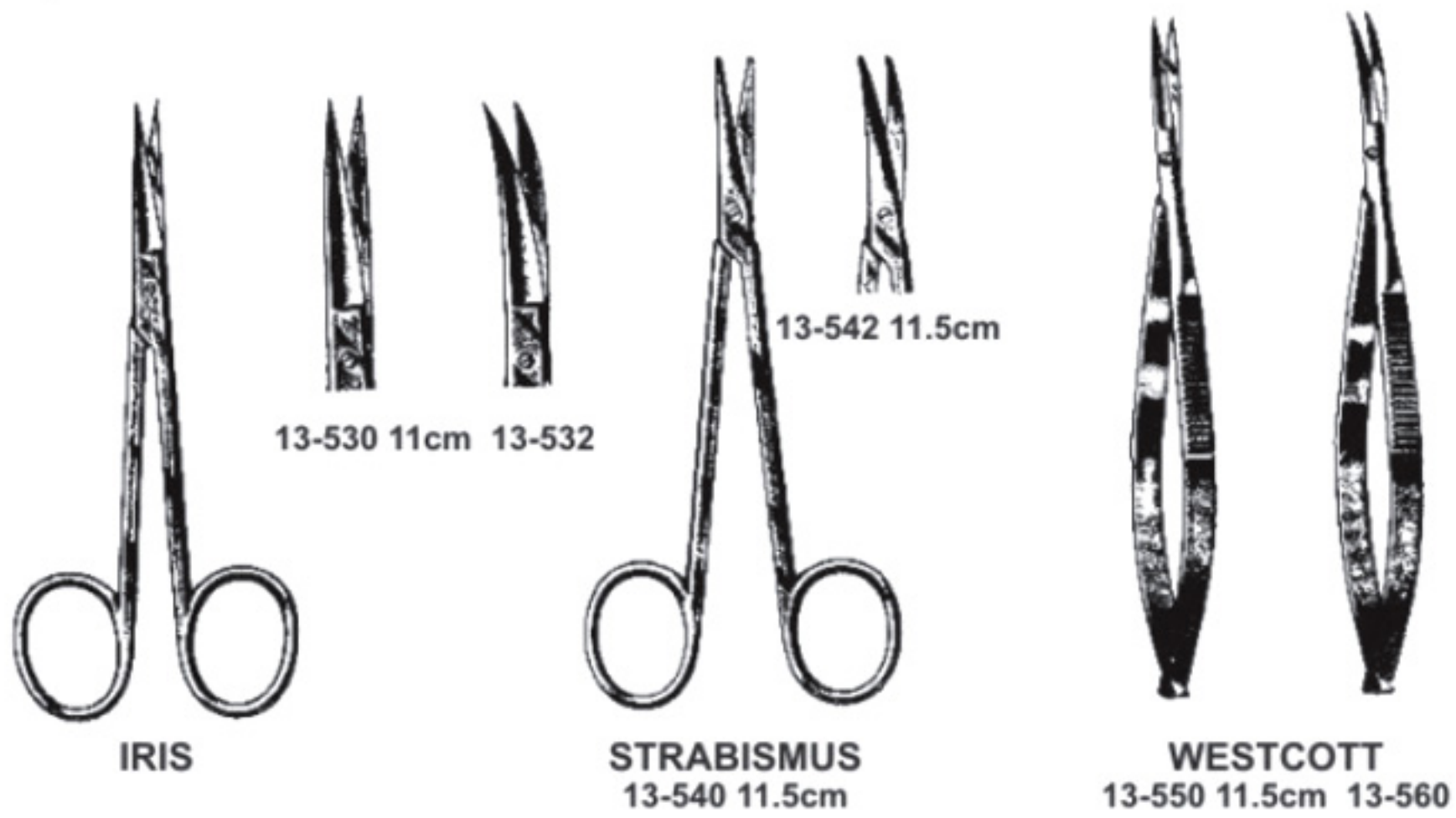

TENOTOMY SCISSORS





GENERAL INSTRUMENTS DRESSING AND TISSUE FORCEPS



**ENGLISH
T.O.E.**
15-100 10 cm
15-102 12.5cm
15-104 15 cm
15-106 18 cm
15-108 20 cm



**ENGLISH
B/END**
15-110 12.5cm
15-112 15 cm
15-114 18 cm



THUMB
15-120 11.5cm
15-121 12.5cm
15-122 14 cm
15-123 16 cm
15-124 20 cm
15-125 25 cm
15-126 30 cm



TREVE
15-130 12.5cm
15-132 15 cm
15-134 18 cm



**1:2
TISSUE**
15-140 11.5cm
15-141 12.5cm
15-142 14 cm
15-143 16 cm
15-144 20 cm
15-145 25 cm
15-146 30 cm



**2:3
TISSUE**
15-150 12.5cm
15-152 14 cm
15-154 16 cm
15-156 18 cm
15-158 20 cm



**3:4
TISSUE**
15-160 12.5cm
15-162 14 cm
15-164 16 cm



**4:5
TISSUE**
15-170
15-172
15-174



BROPHY
15-180 20cm



BROPHY
15-190 20cm



POTTS-SMITH
15-200 18 cm
15-202 21 cm
15-204 25 cm



15-210
15-212
15-214



GENERAL INSTRUMENTS DRESSING AND TISSUE FORCEPS



CUSHING
15-220 17.5cm



CUSHING
15-230 17.5cm



1:2
BROPHY
15-240 20cm



1:2
BROPHY
15-250 20cm



1:2 POTTS SMITH
15-260 18cm 15-270
15-262 21cm 15-272
15-264 25cm 15-274



1:2



1:2
CUSHING
15-280 17.5cm



1:2
CUSHING
15-290 17.5cm



ADSON
15-300 12cm



McINDOE
15-310 15cm



SEMKEN
15-320 12.5cm 15-322 15 cm



ADSON
15-330 12cm



GILLIS
15-340 15cm



GENERAL INSTRUMENTS

DRESSING AND TISSUE FORCEPS

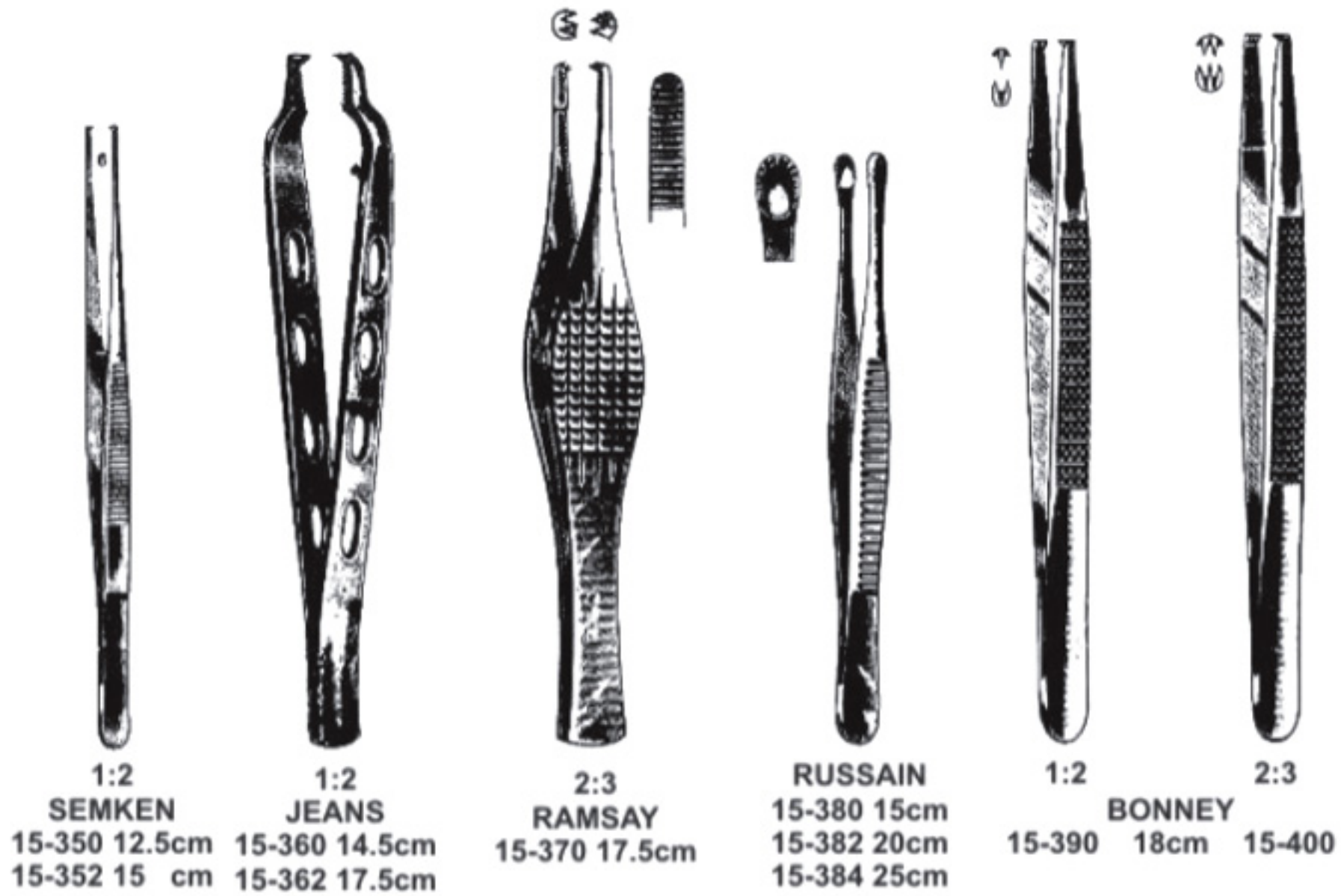

SPLINTER FORCEPS

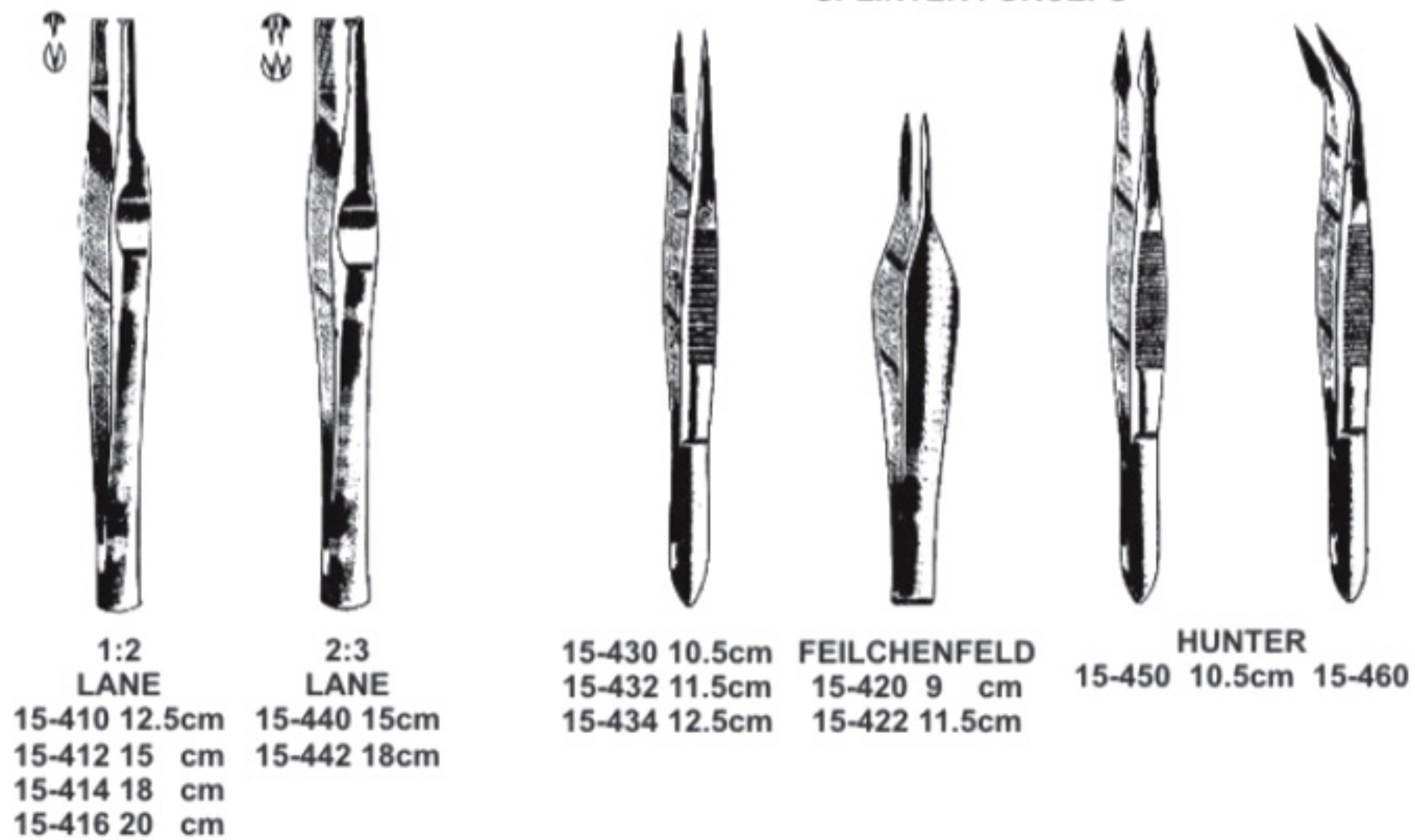



GENERAL INSTRUMENTS

SPLINTER FORCEPS



WALTER-CARMALT
15-470 10.5cm 15-480



PEET
15-490 11.5cm



STIEGLITZ
STR CUR
15-500 14cm 15-502



26 ARTHUR
STR CUR
15-510 14cm 15-512



RALK
15-520 15cm

HAEMOSTATIC FORCEPS



CARREL
17-100 8.5cm



TERRIER
17-110 8.5cm



GENERAL INSTRUMENTS HAEMOSTATIC FORCEPS



HARTMAN
STR 17-120 10cm CUR 17-122



**HALSTEAD
MOSQUITO**
17-130 12.5cm
17-132 12.5cm



**HALSTEAD
MOSQUITO**
STR 17-140 12.5cm CUR 17-142



**1:2
HALSTEAD
MOSQUITO**
STR 17-150 12.5cm CUR 17-152

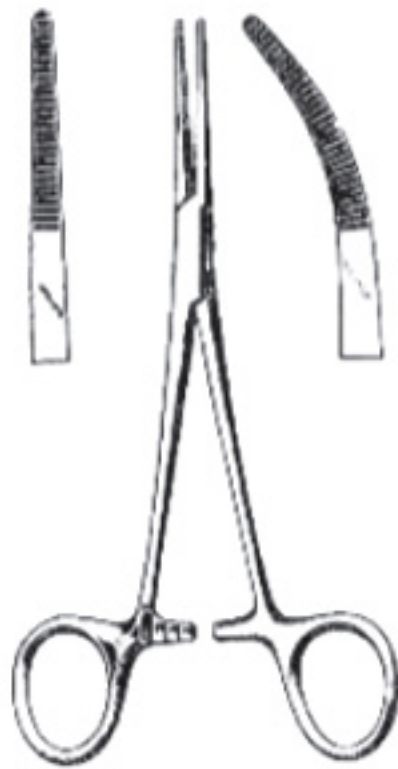

**1:2
KELLY**
STR 17-160 14cm CUR 17-162



CRILE
STR 17-170 14cm CUR 17-172



KELLY-RANKIN
STR 17-180 16cm CUR 17-182



GENERAL INSTRUMENTS HAEMOSTATIC FORCEPS



CRILE-RANKIN
STR CUR
17-190 16cm 17-192



PROVIDENCE-HOSPITAL
STR CUR
17-200 14cm 17-202



DANDY
17-210 14cm



PEAN
STR CUR
17-220 12.5cm 17-230
17-222 14 cm 17-232
17-224 16 cm 17-234



PEAN
17-240 14cm
17-242 16cm



ROCHESTER PEAN
STR CUR
17-250 12.5cm 17-260
17-251 14 cm 17-261
17-252 16 cm 17-262
17-253 18 cm 17-263
17-254 20 cm 17-264
17-255 24 cm 17-265
17-256 26 cm 17-266



GENERAL INSTRUMENTS HAEMOSTATIC FORCEPS



KROENLEIN
17-270 14cm 17-272



SPENCERWELLS
STR CUR
17-280 12.5cm 17-290
17-282 15 cm 17-292
17-284 18 cm 17-294
17-286 20 cm 17-296
17-288 23 cm 17-298



SPENCERWELLS
STR CUR
17-300 12.5cm 17-310
17-302 15 cm 17-312
17-304 18 cm 17-314
17-306 20 cm 17-316
17-308 23 cm 17-318



KILNER
17-320 14cm

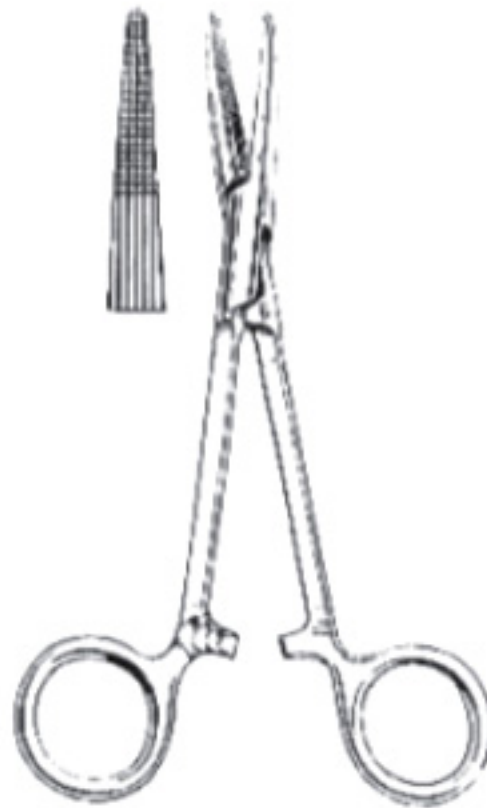

GREY -TURNER
17-330 15cm



DUNHILL
17-340 12.5cm



GENERAL INSTRUMENTS HAEMOSTATIC FORCEPS



KOCHER
STR **CUR**
 17-350 12.5cm 17-360
 17-352 14 cm 17-362
 17-354 15 cm 17-364
 17-356 18 cm 17-366
 17-358 20 cm 17-368



KOCHER
STR **CUR**
 17-370 12.5cm 17-380
 17-371 14 cm 17-381
 17-372 15 cm 17-382
 17-373 16 cm 17-383
 17-374 18 cm 17-384
 17-375 20 cm 17-385
 17-376 23 cm 17-386
 17-377 26 cm 17-387



ROCHESTER OCHSNER
STR **CUR**
 17-390 14cm 17-400
 17-391 16cm 17-401
 17-392 18cm 17-402
 17-393 20cm 17-403
 17-394 22cm 17-404
 17-395 24cm 17-405
 17-396 26cm 17-406

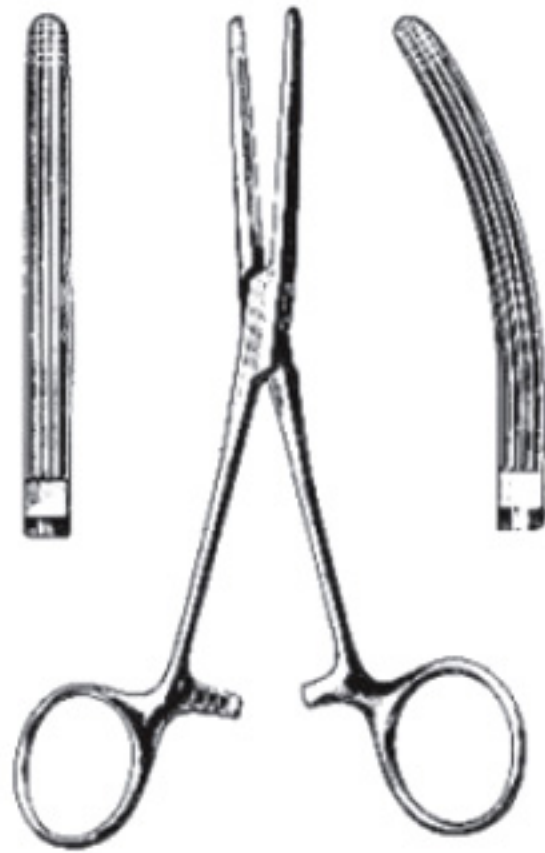

ROCHESTER CARMALT
STR **CUR**
 17-410 16cm 17-420
 17-412 20cm 17-422



CHAPUT
 17-430 13cm



LANE
 17-440 12.5cm
 17-442 15 cm
 17-444 19 cm



GENERAL INSTRUMENTS HAEMOSTATIC FORCEPS



COLLIN
17-450 16cm
17-452 16cm
17-454 16cm
17-456 16cm

HOPFNER
17-460 16cm

COLLIN
17-470 14cm



WILLET-MARTEL
17-480 19cm

PRATT
17-490 15cm

PENNINGTON
17-500 15.5cm
17-502 20cm



GENERAL INSTRUMENTS HAEMOSTATIC FORCEPS

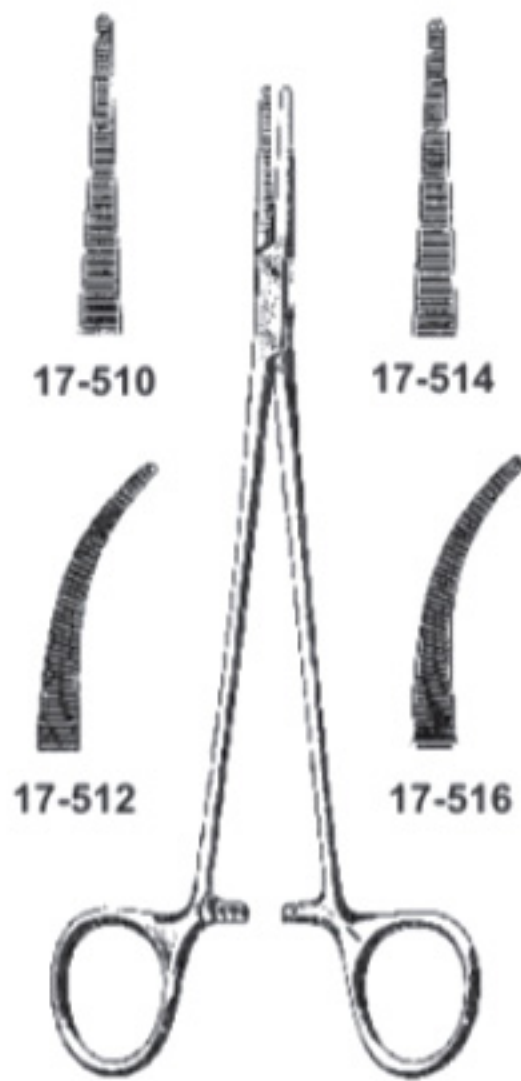

HALSTEAD MOSQUITO

	STR	CUR
17-510	18cm	17-512
17-514	1:2 18cm	1:2 17-516
17-520	20cm	17-522
17-524	1:2 20cm	1:2 17-526



BAINBRIDGE

	STR	CUR
17-550	15cm	17-560
17-452	18cm	17-562

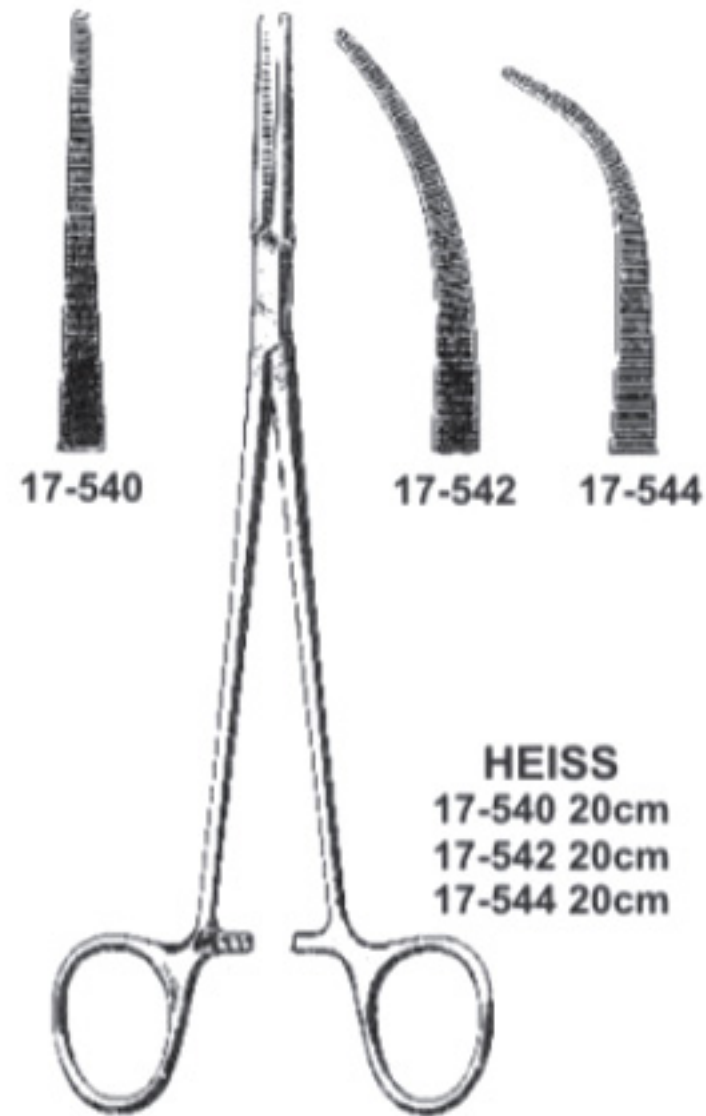

HEISS
17-540 20cm
17-542 20cm
17-544 20cm

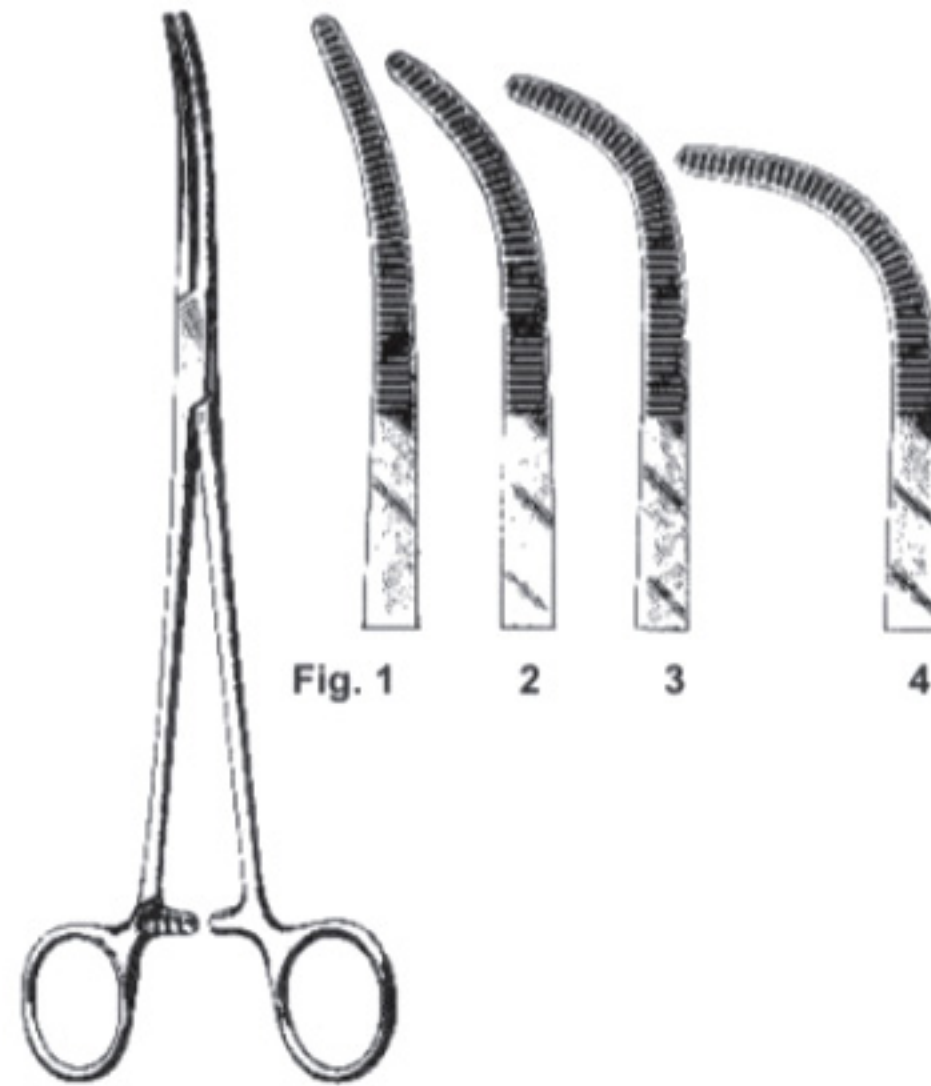

RUMMEL
17-570 Fig. 1 23cm
17-572 Fig. 2 23cm
17-574 Fig. 3 23cm
17-576 Fig. 4 23cm



GENERAL INSTRUMENTS HAEMOSTATIC AND GALL DUCT FORCEPS

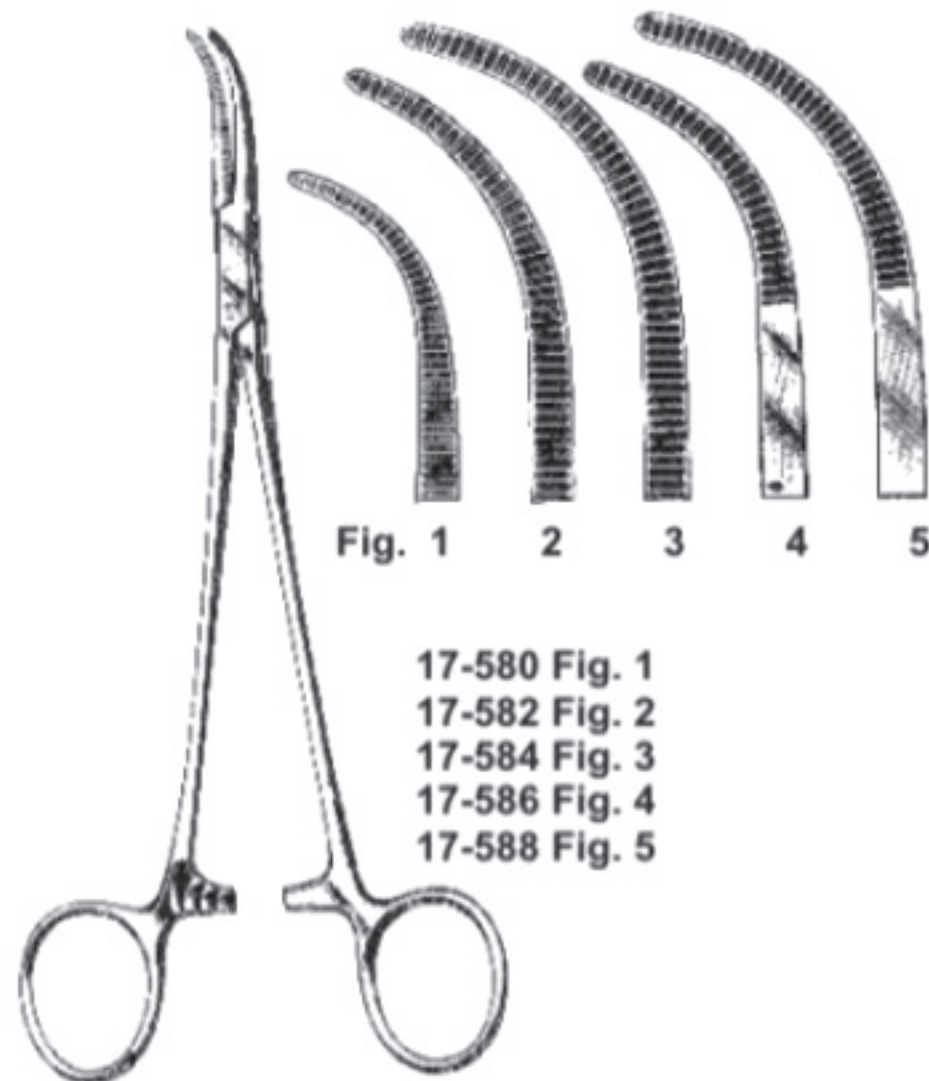

Fig. 1 2 3 4 5

- 17-580 Fig. 1
- 17-582 Fig. 2
- 17-584 Fig. 3
- 17-586 Fig. 4
- 17-588 Fig. 5

OVERHOLT - GEISSENDORFER
21cm



MIXTER
17-590 15.5cm
17-592 19 cm



MIXTER
17-600 22cm

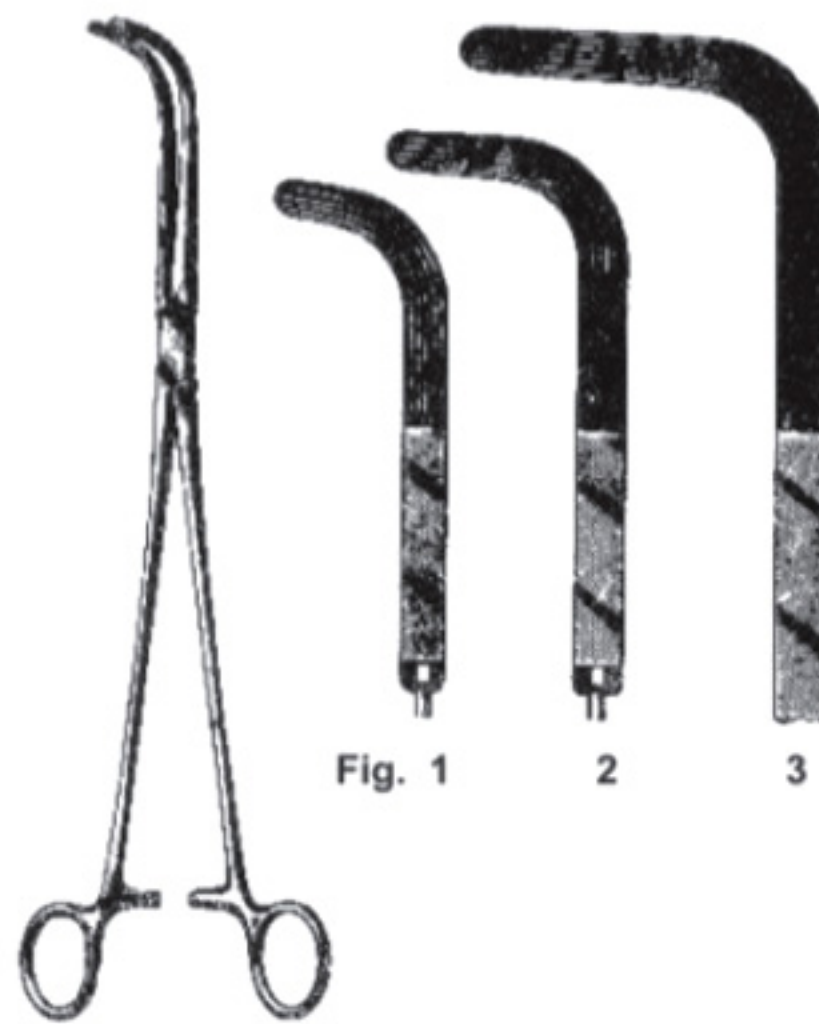

Fig. 1 2 3

MIXTER
17-610 Fig. 1 22cm
17-612 Fig. 2 25cm
17-614 Fig. 3 28cm



GENERAL INSTRUMENTS GALL DUCT FORCEPS



BABY MIXTER
17-620 14cm

LAHEY
17-630 19cm

LOWER
17-640 18cm

FINOCCHIETTO
17-650 24cm

KIDNEY PEDICAL FORCEPS



34

STILLE
17-660 23cm

MAYO
17-670 23cm

MAYO-GUYON
17-680 23cm

GUYON
17-690 23.5cm



GENERAL INSTRUMENTS

GALL DUCT FORCEPS

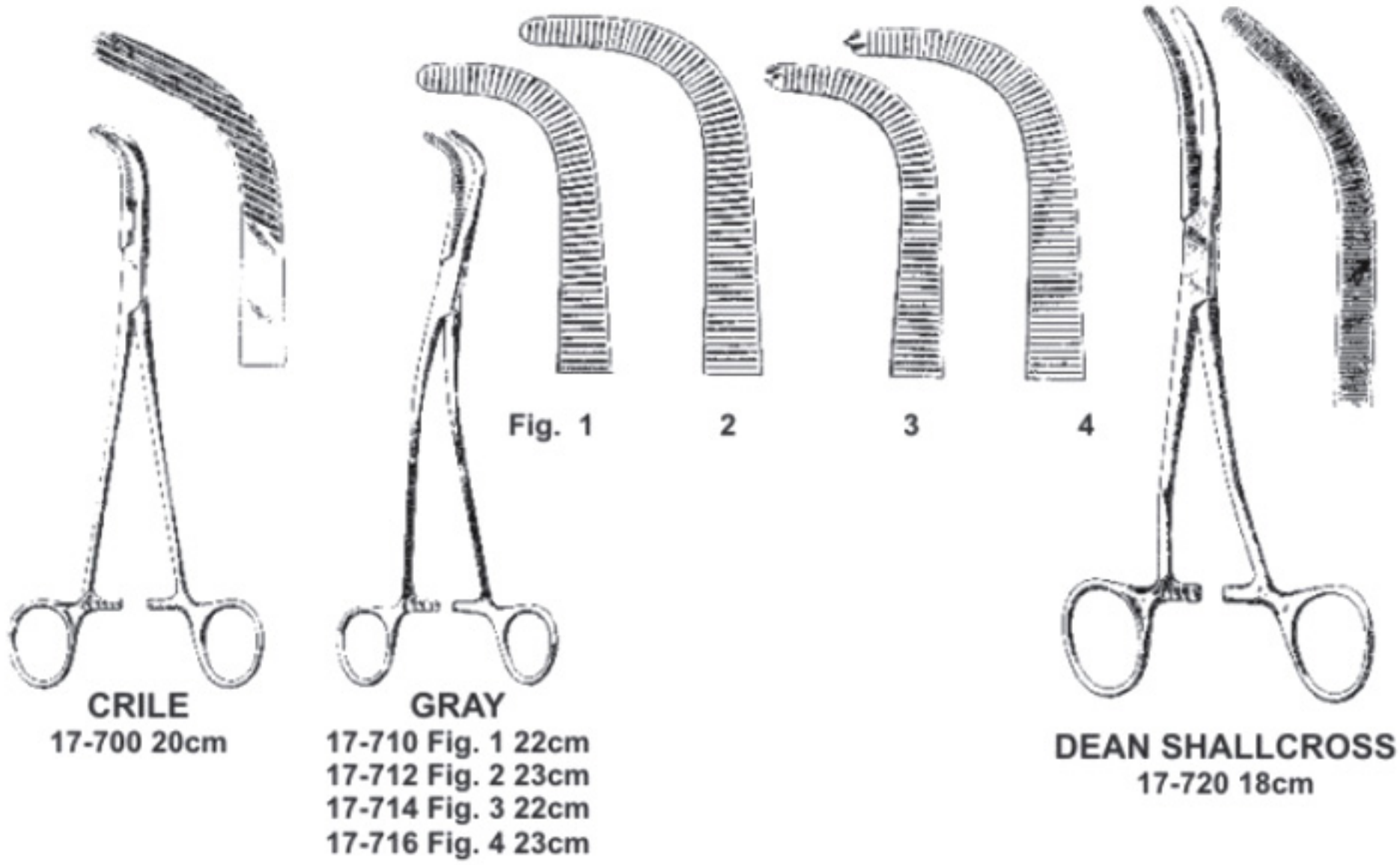

PERITONEAL FORCEPS

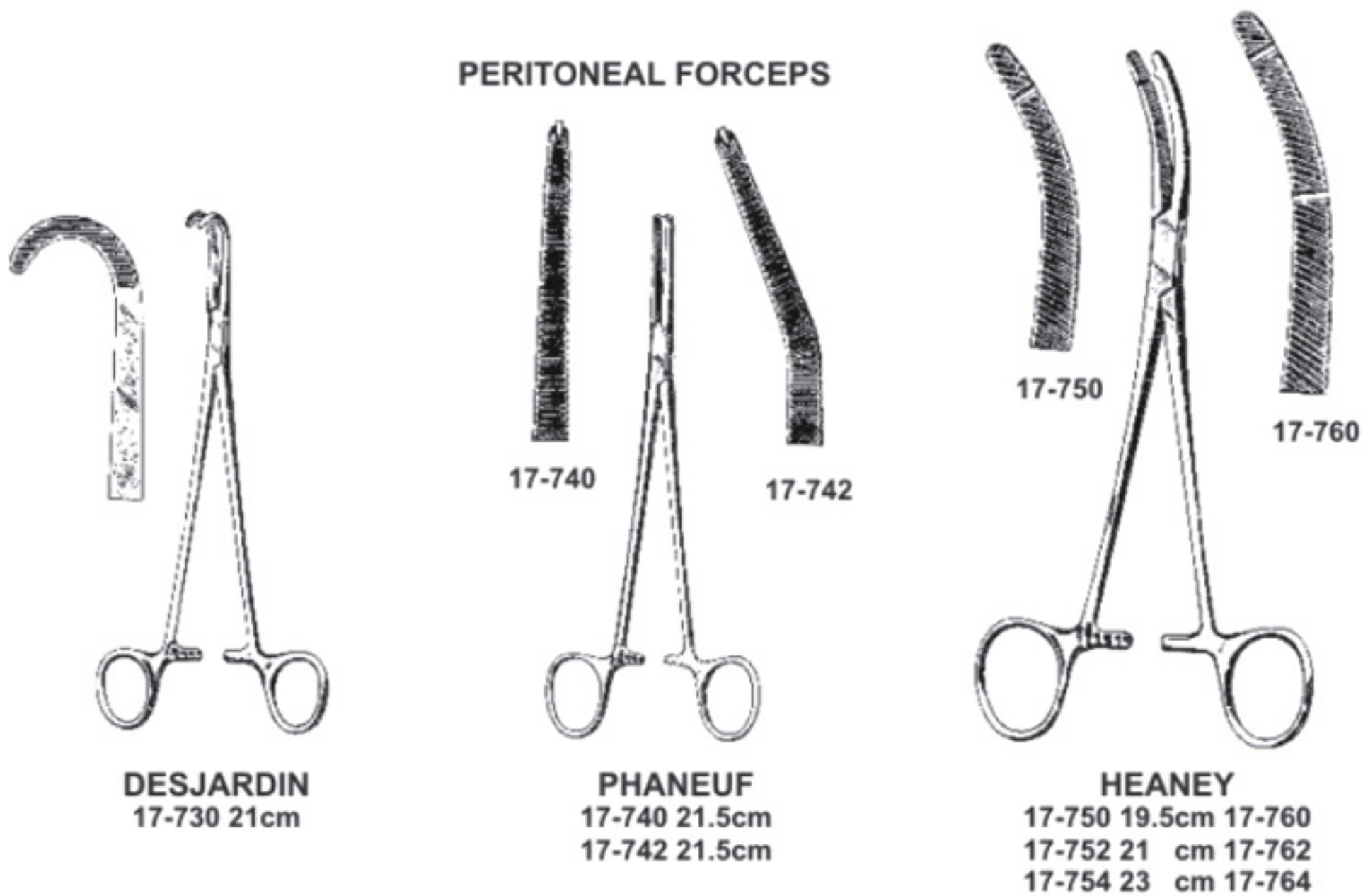



GENERAL INSTRUMENTS HYSTERECTOMY FORCEPS

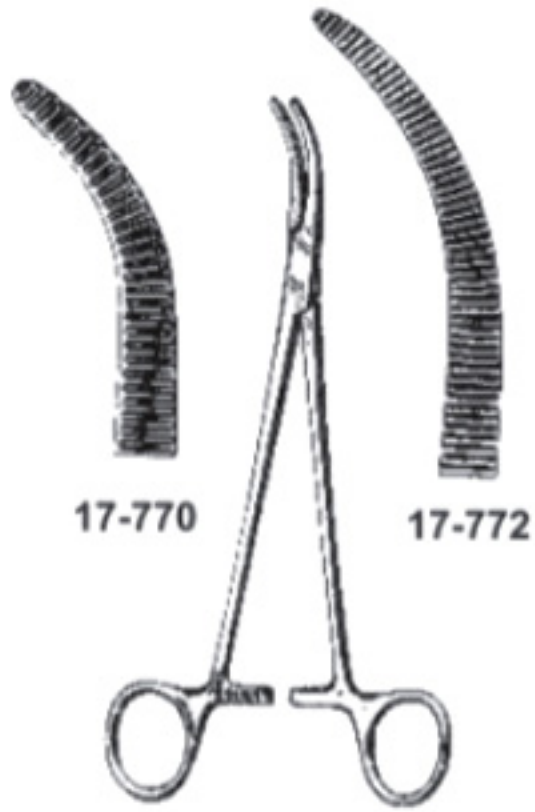

MOYNIHAN
17-770 23cm
17-772 24cm

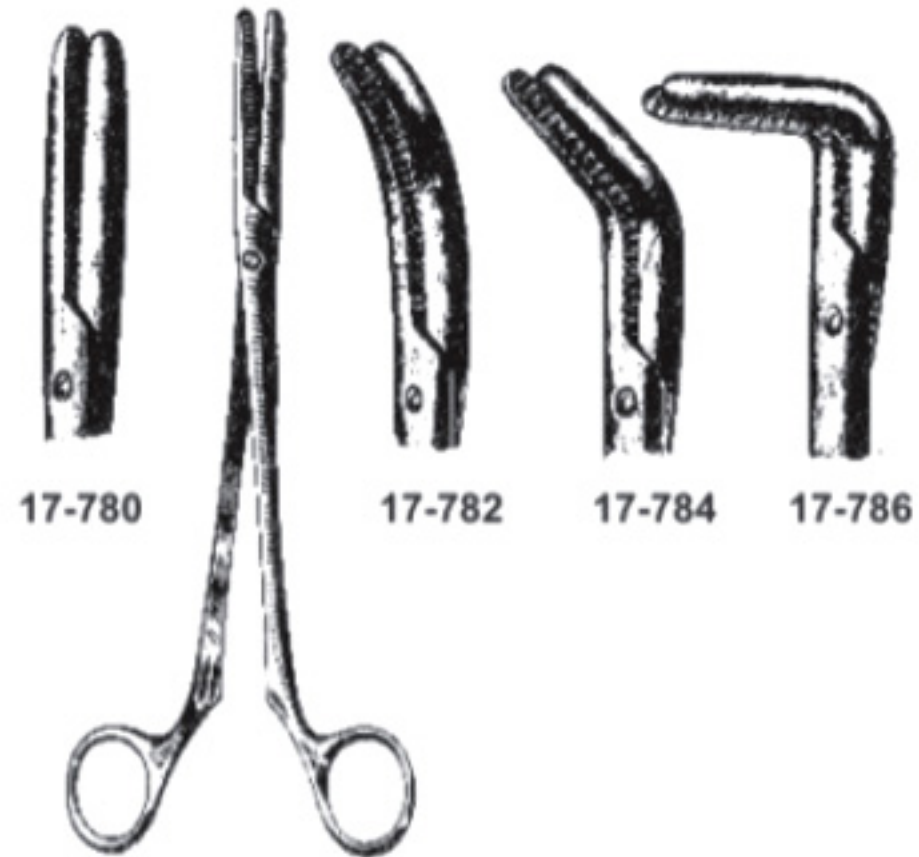

SPENCERWELLS
17-780 24cm
17-782 24cm
17-784 24cm
17-786 24cm



FAURE
17-790 25cm



WERTHEIM
17-800 25cm



WERTHEIM
17-810 23cm



WERTHEIM-CULLEN
17-820 21.5cm



GENERAL INSTRUMENTS PERITONEAL FORCEPS

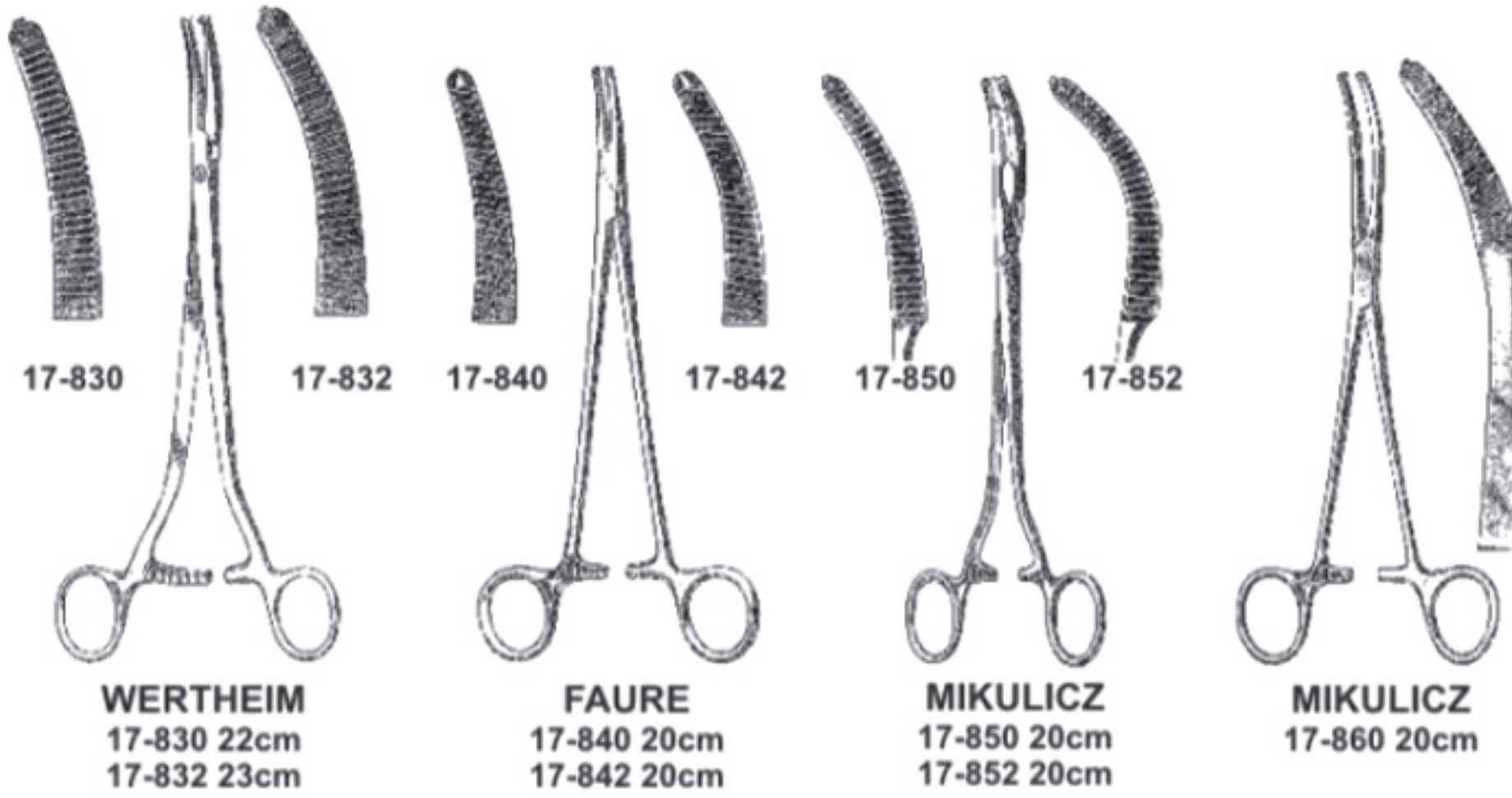

BRONCHUS FORCEPS

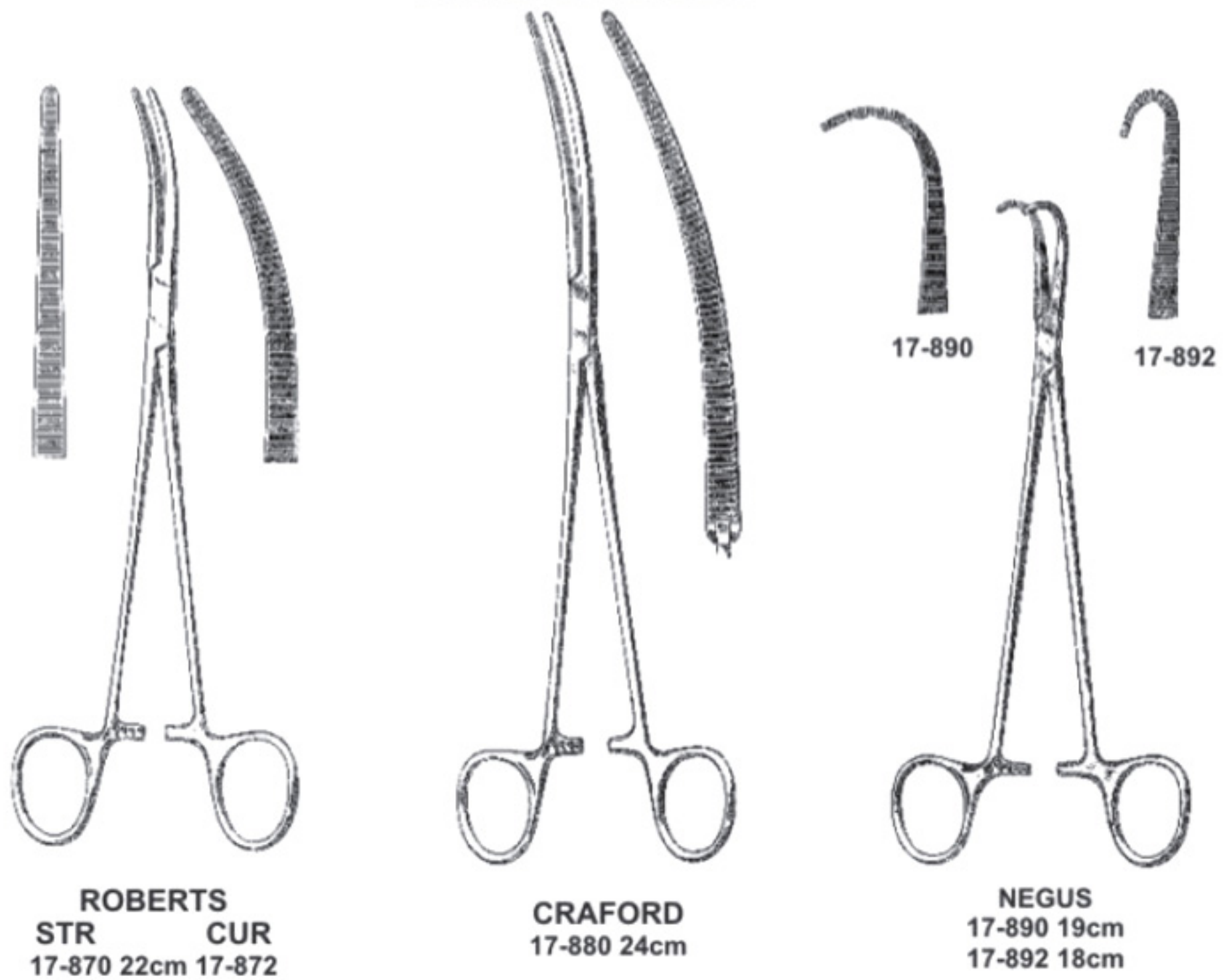



GENERAL INSTRUMENTS

TOWEL CLAMPS



BACKHAUS
17-900 8cm
17-902 10cm
17-904 13cm



BACKHAUS
17-910 8cm
17-912 10cm
17-914 13cm



BACKHAUS-ROEDER
17-920 13cm
17-922 15cm



MAYO
17-930 14cm



MOYNIHAN
17-940 19cm



MOYNIHAN
17-950 18cm



DOYEN
17-960 18cm



SCHAEDEL
17-970 9cm



JONES
17-980 9cm



GENERAL INSTRUMENTS SINUS AND DRESSING FORCEPS

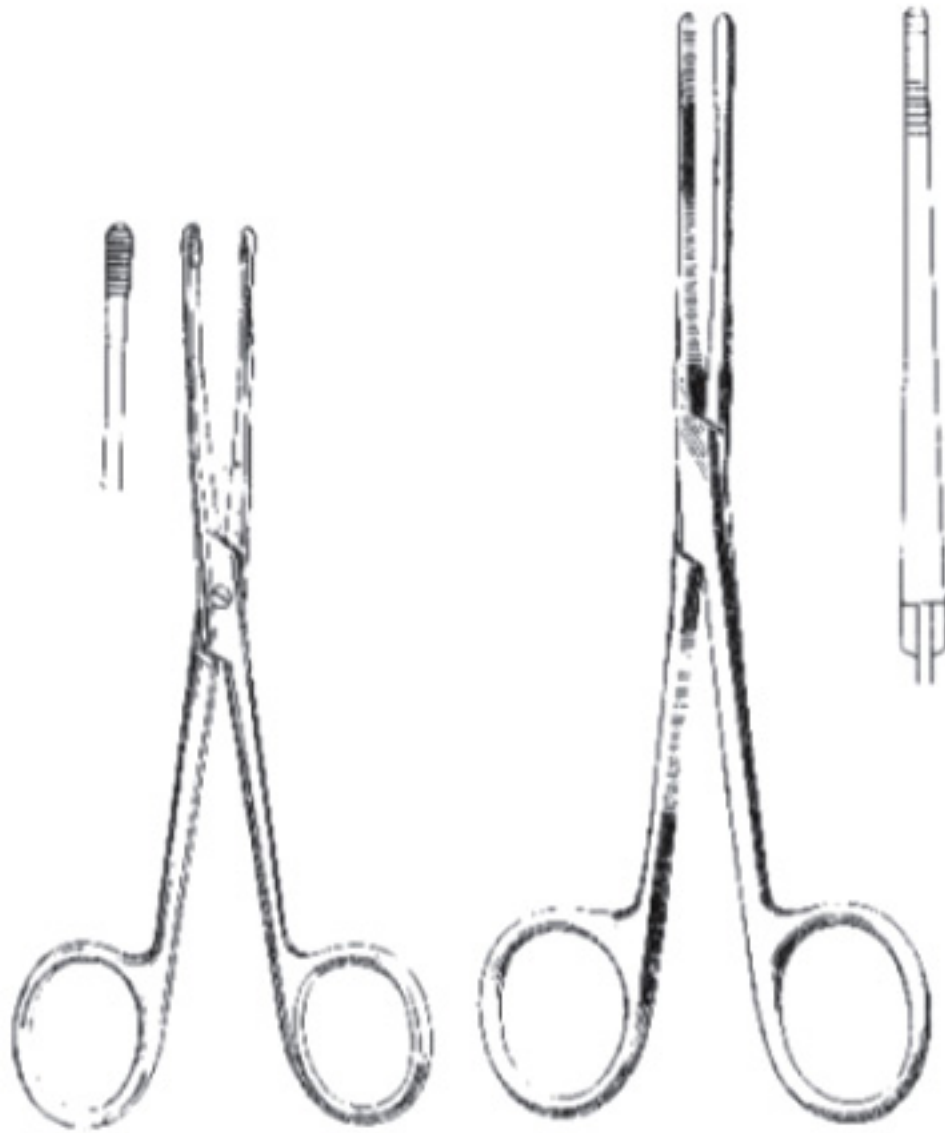

LISTER
19-790 12.5cm
19-792 15 cm
19-794 18 cm
19-796 20 cm

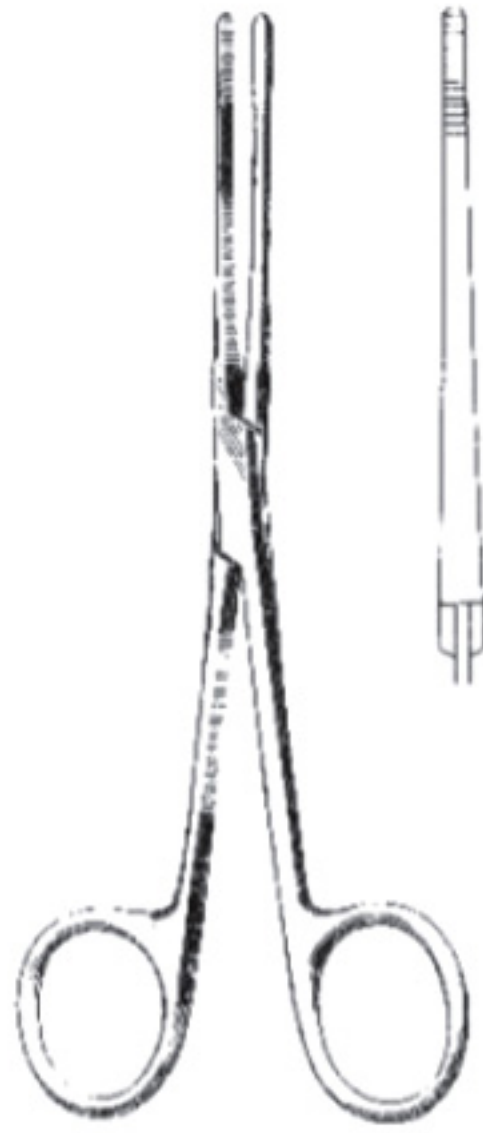

LISTER
19-800 12.5cm
19-802 15 cm
19-804 18 cm
19-806 20 cm



BRYANT
19-810 12.5cm



BRYANT
19-820 12.5cm



FRENCH
STR CUR
19-830 12.5cm 19-832



GROSS
STR CUR
19-840 14cm 19-850
19-842 16cm 19-852

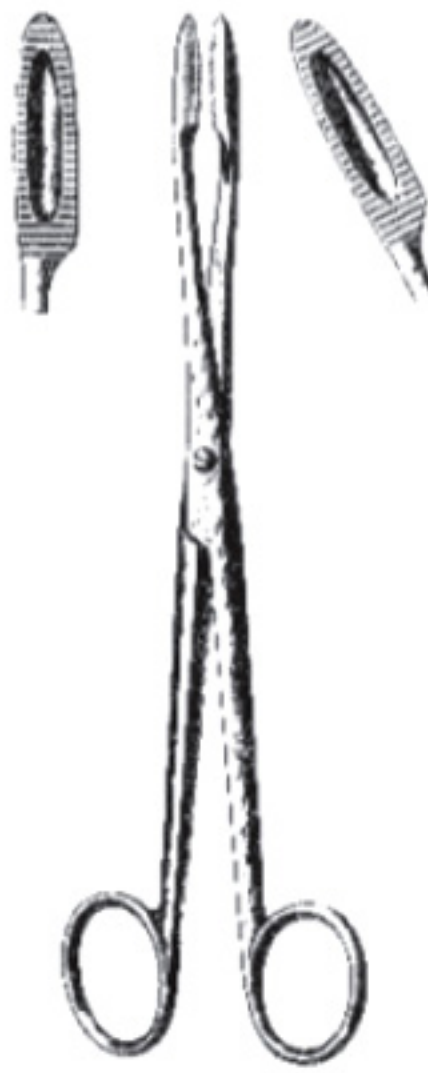

GROSS
STR CUR
19-860 18cm 19-870
19-862 20cm 19-872



GROSS
STR CUR
19-880 18cm 19-890
19-882 20cm 19-892



GENERAL INSTRUMENTS DRESSING FORCEPS



GROSS
STR CUR
19-900 20cm 19-902



MAIER
STR CUR
19-910 25cm 19-912

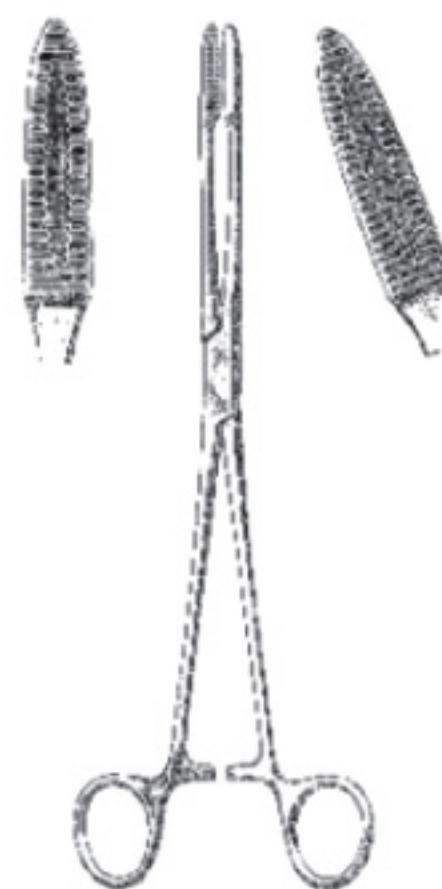

MAIER
STR CUR
19-920 25cm 19-922



SIMS-MAIER
STR CUR
19-930 28cm 19-932



COLLIN
19-940 25cm



CHERON
19-950 25cm S/Lock
19-952 25cm B/Lock



GENERAL INSTRUMENTS

DRESSING AND SPONGE FORCEPS

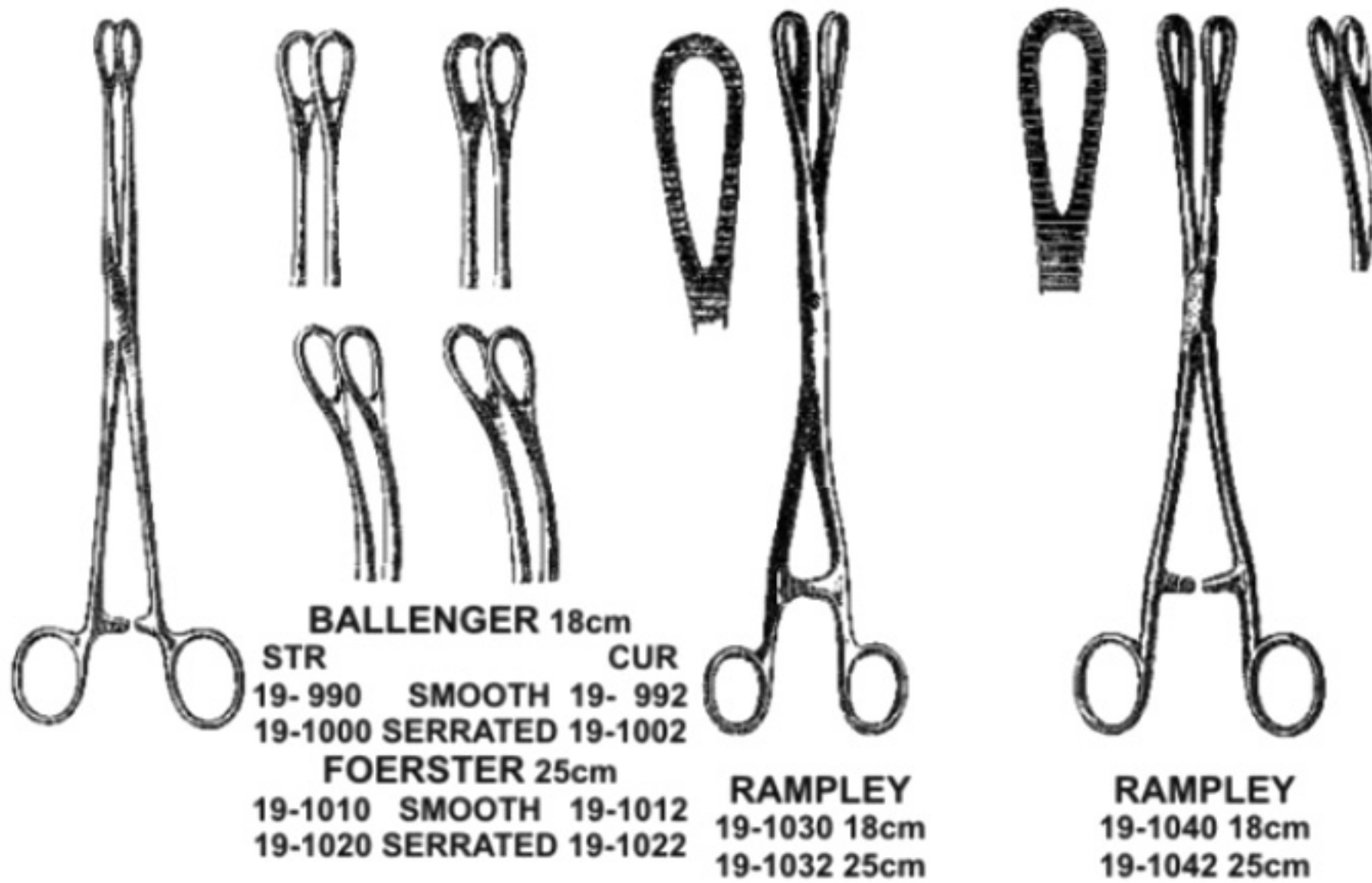
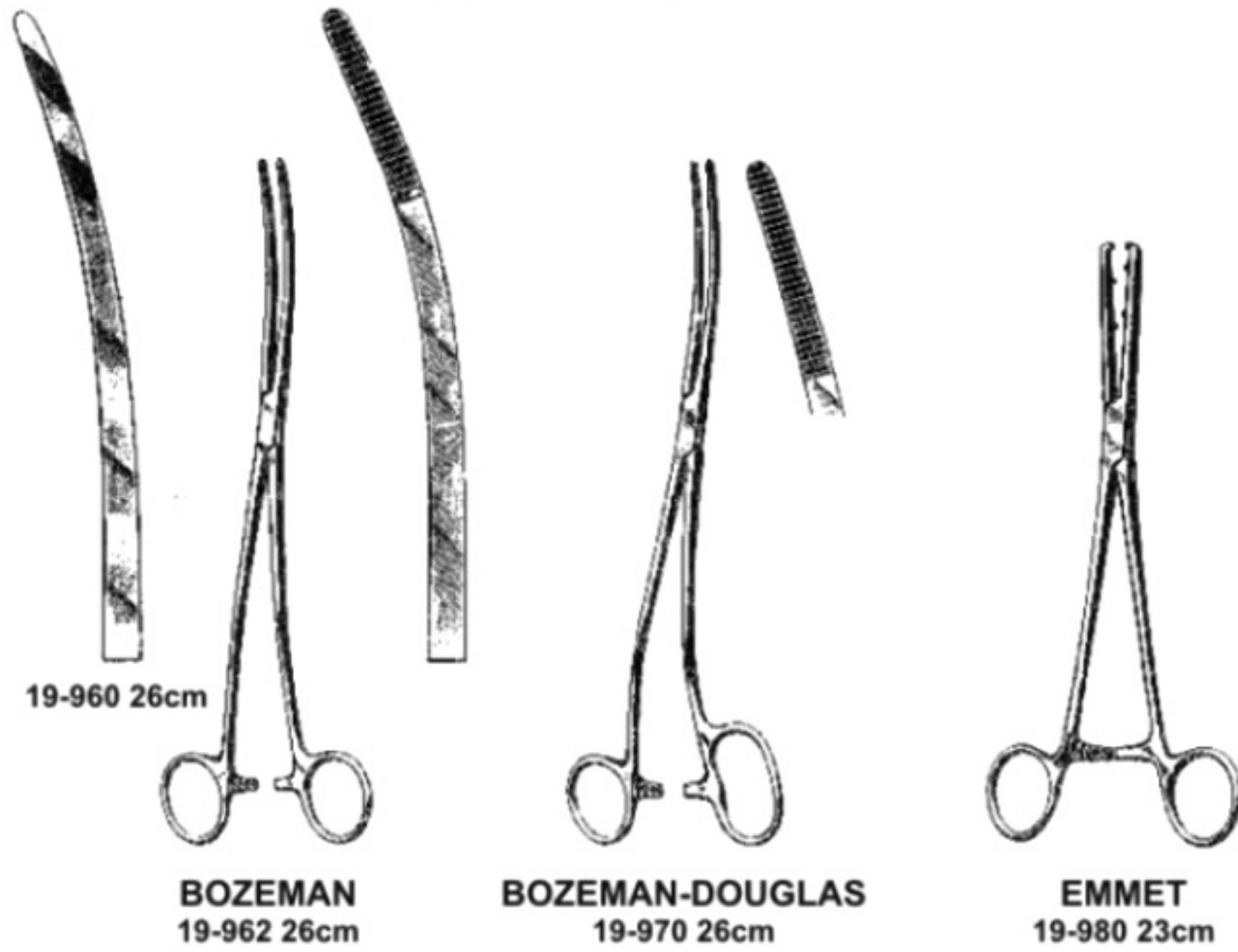



GENERAL INSTRUMENTS RETRACTORS

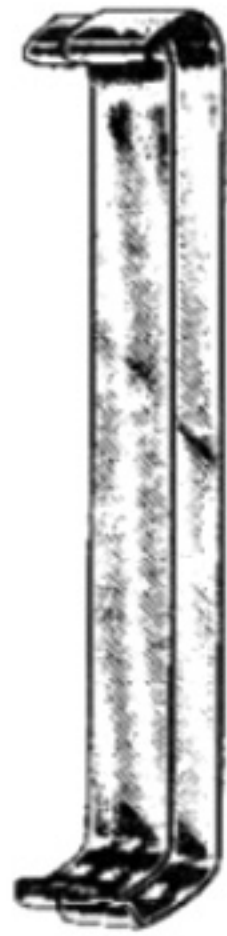

FARABEU
21-100 12cm
21-102 15cm

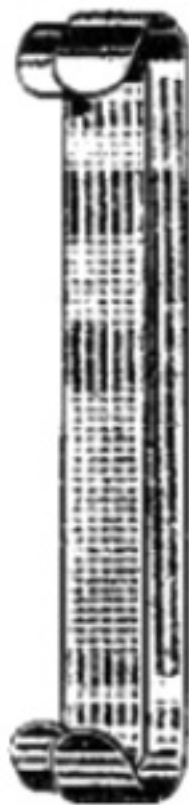

PARKER
21-110 13.5cm



U. S. ARMY
21-120 21cm



ROUX
21-130 Set
21-132 14cm
21-134 15cm
21-136 16cm

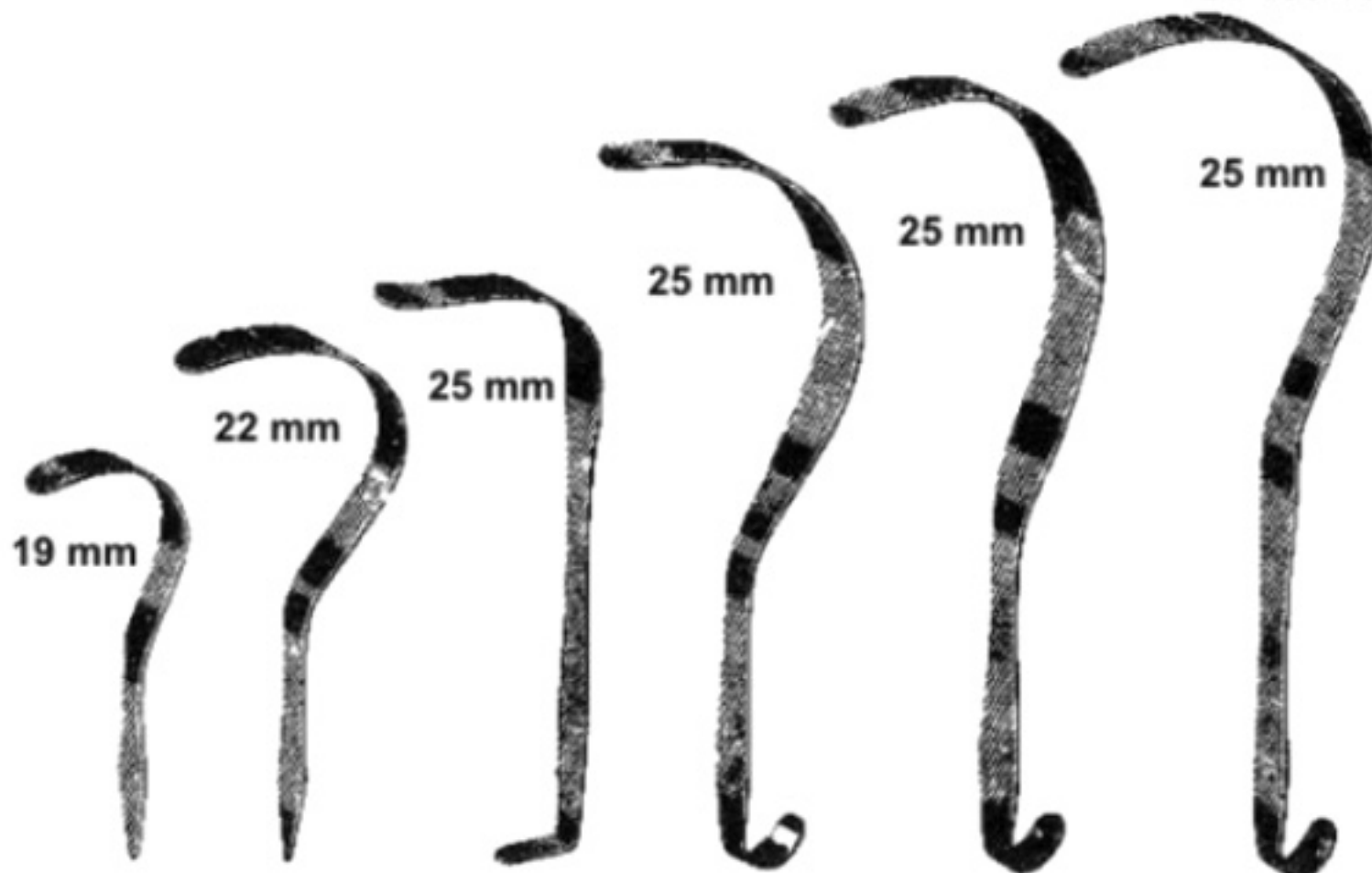

DEAVER
21-140 18cm 21-141 21.5cm 21-142 23cm 21-143 30cm 21-144 33cm 21-145 36cm



GENERAL INSTRUMENTS RETRACTORS

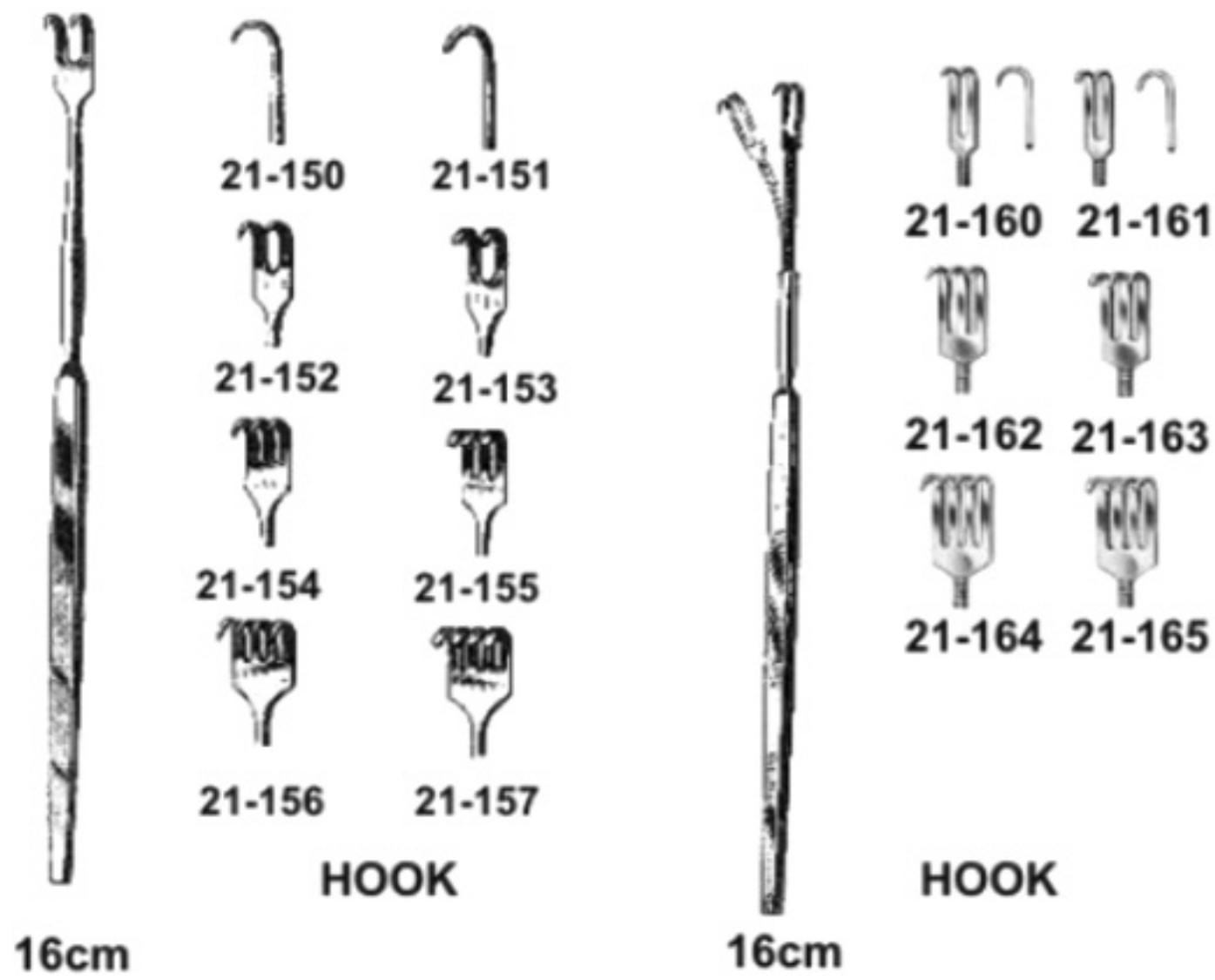
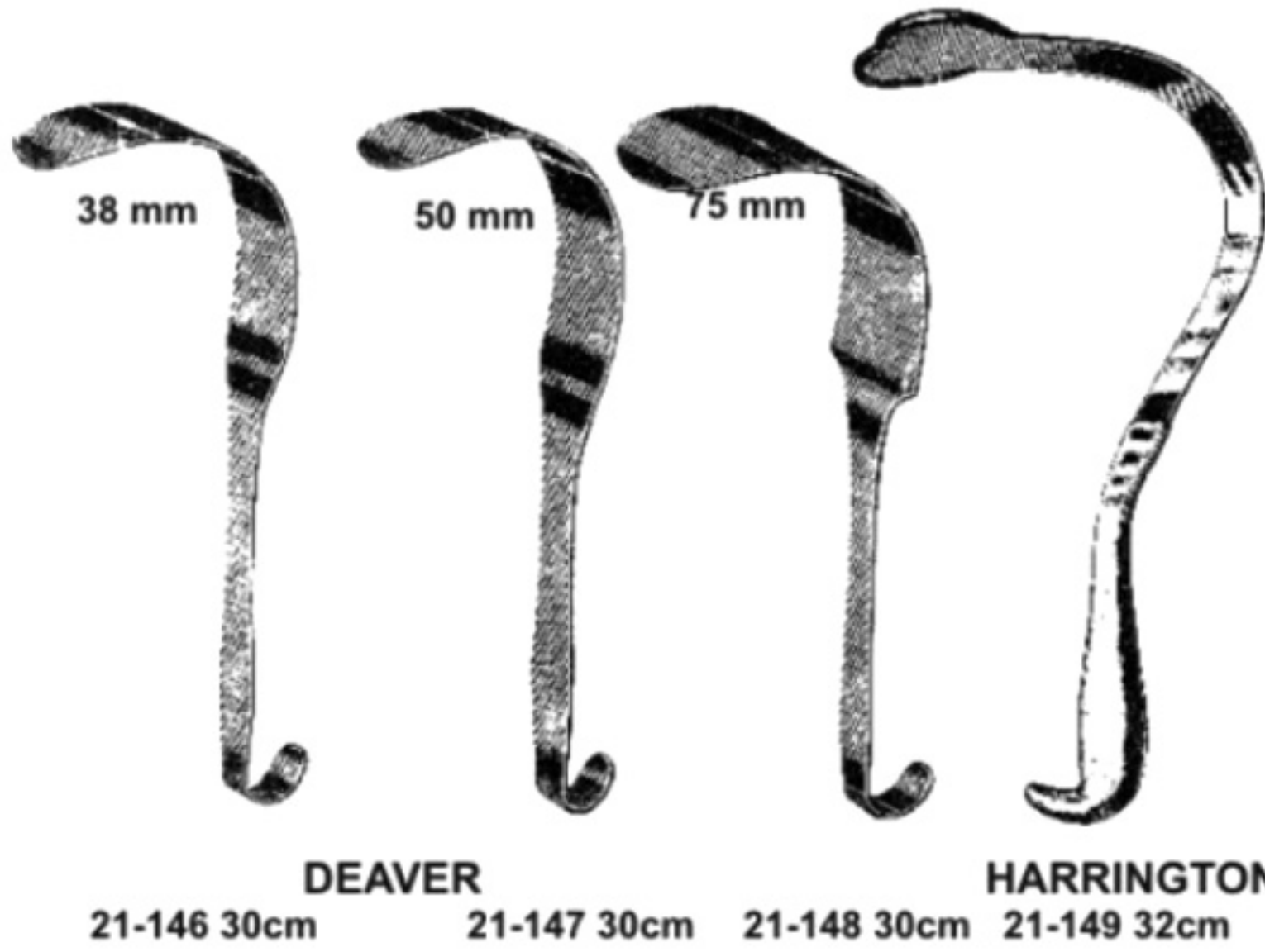



GENERAL INSTRUMENTS

RETRACTORS



KOCHER
22cm



21-170



21-171



21-172



21-173



21-174



21-175



21-176



21-177



21-178



21-179



VOLKMAN
21.5cm



21-180



21-181



21-182



21-183



21-184



21-185



21-186



21-187



21-188



21-189



GENERAL INSTRUMENTS RETRACTORS

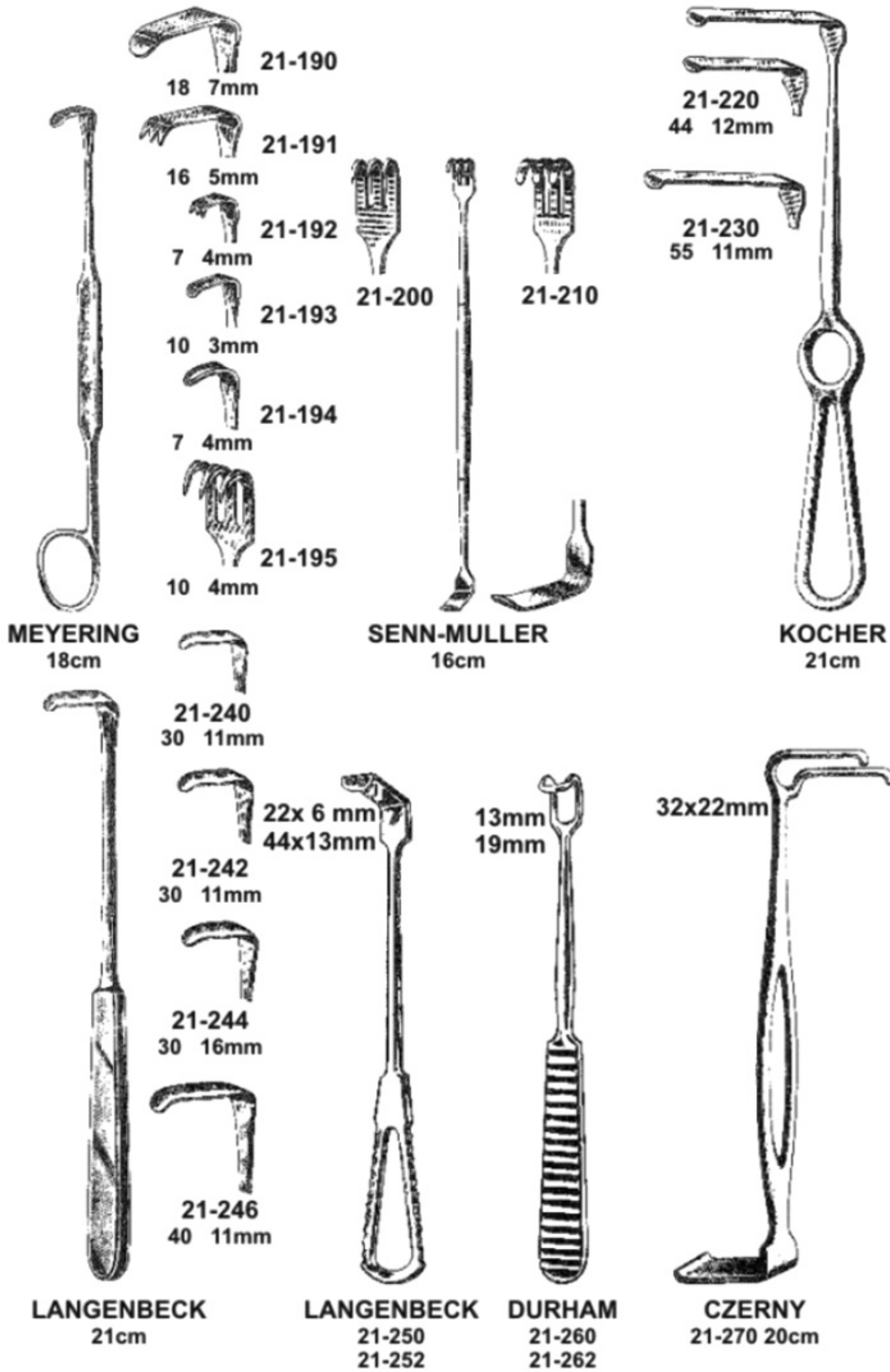



GENERAL INSTRUMENTS

RETRACTORS

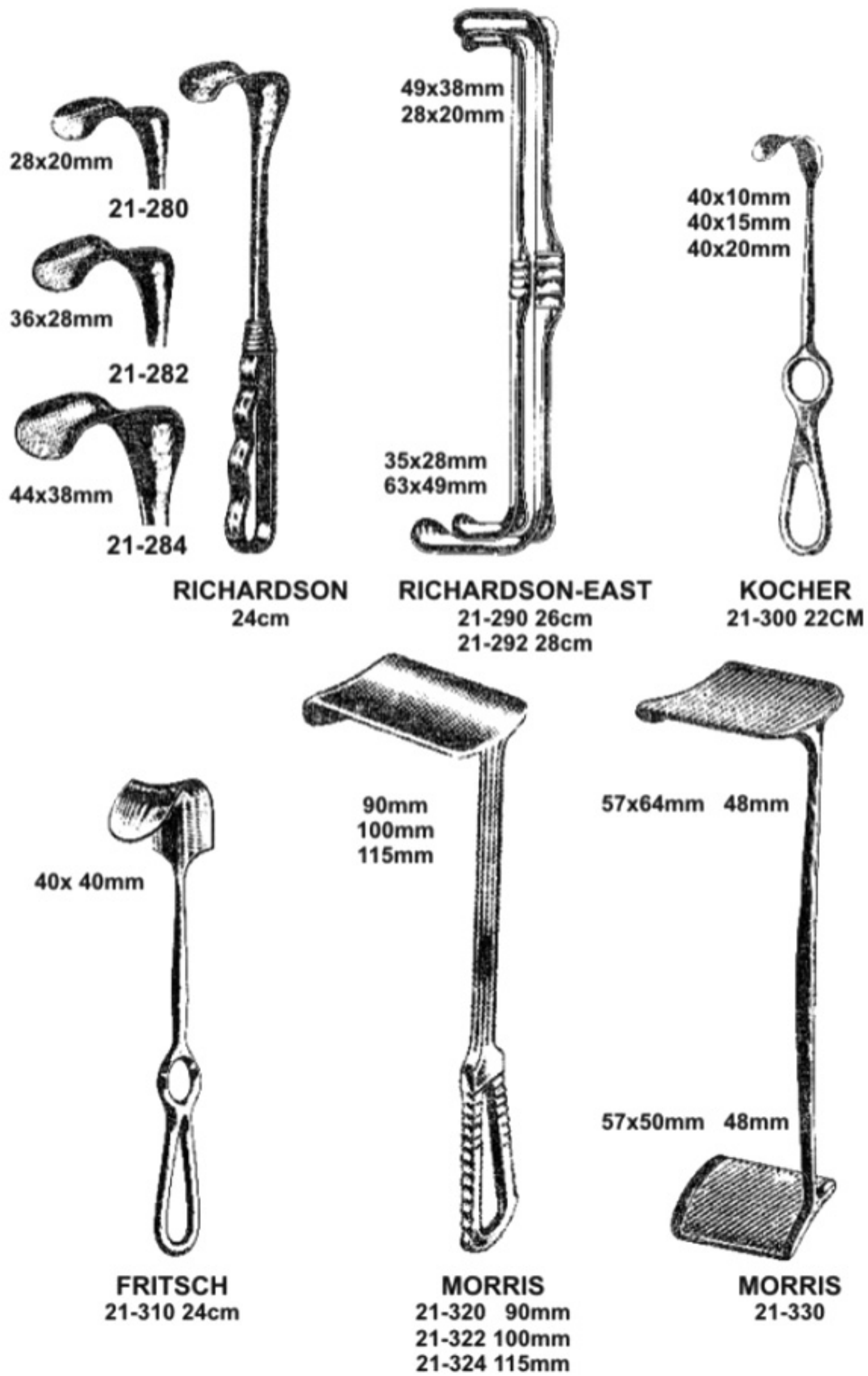



GENERAL INSTRUMENTS

RETRACTORS

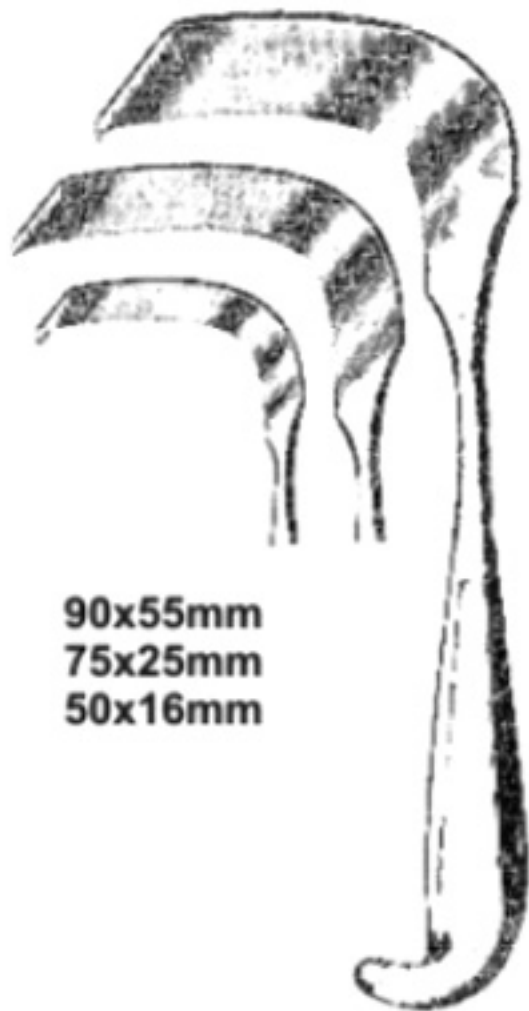

90x55mm
75x25mm
50x16mm

MEYERDING
21-340 24cm
21-342 22cm
21-344 20cm

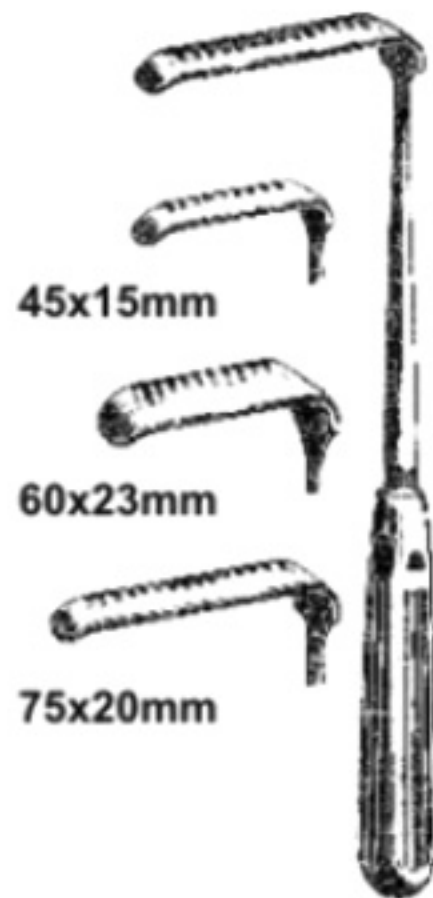

45x15mm
60x23mm
75x20mm

SAUERBRUCH
21-350 22.5cm



50x85mm

DOYEN
21-360 25cm

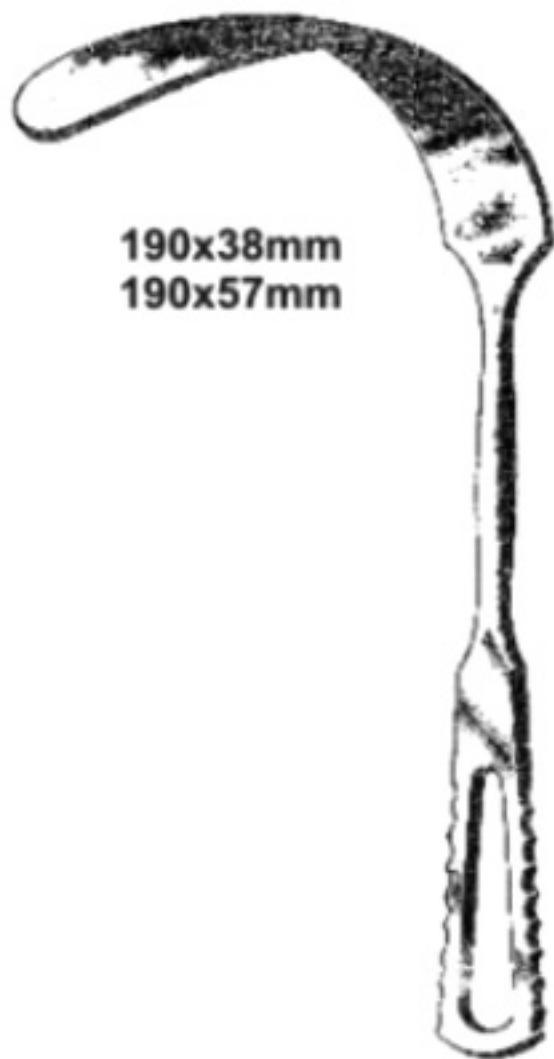

190x38mm
190x57mm

KELLY
21-370 27CM



85x35mm

MIKULICZ
21-380 26cm

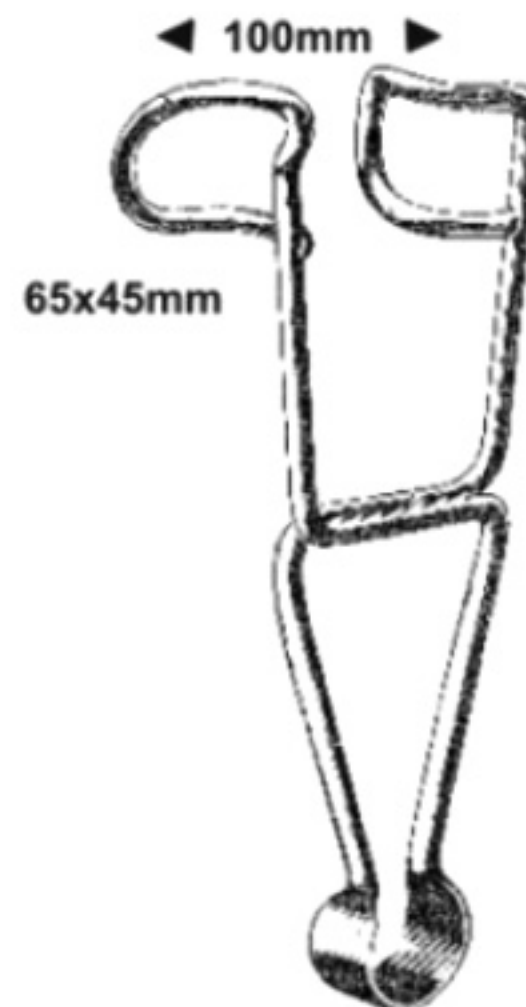

100mm
65x45mm

DARTIGUS
21-390



GENERAL INSTRUMENTS

RETRACTORS

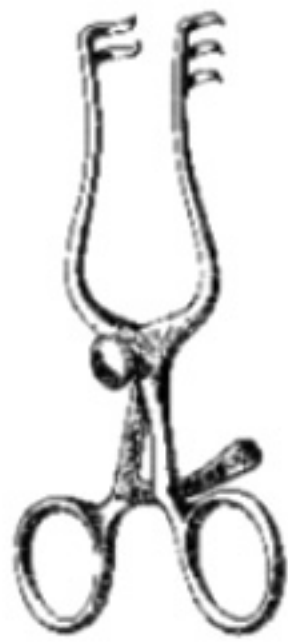

WEITLANER
21-400 10.5cm SHARP
21-402 10.5cm BLUNT

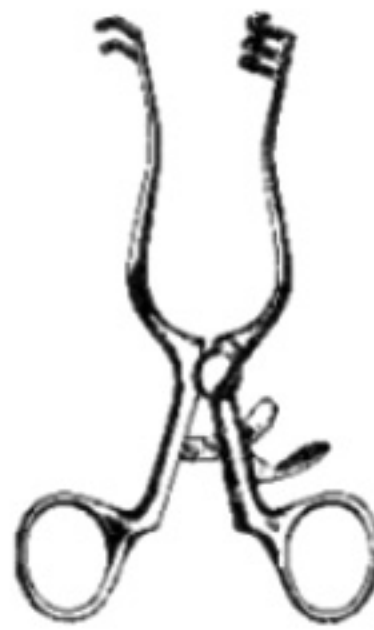

WEITLANER
21-410 10.5cm SHARP
21-412 10.5cm BLUNT

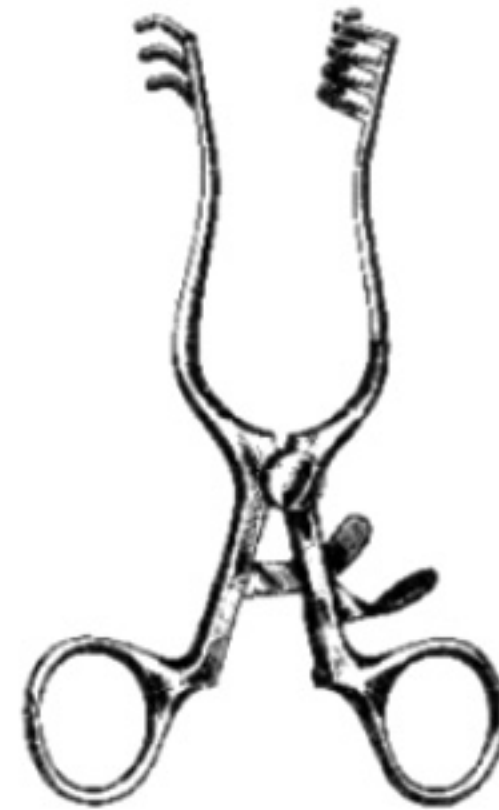

WEITLANER
21-420 13 cm SHARP
21-422 16.5cm SHARP
21-424 13 cm BLUNT
21-426 16.5cm BLUNT

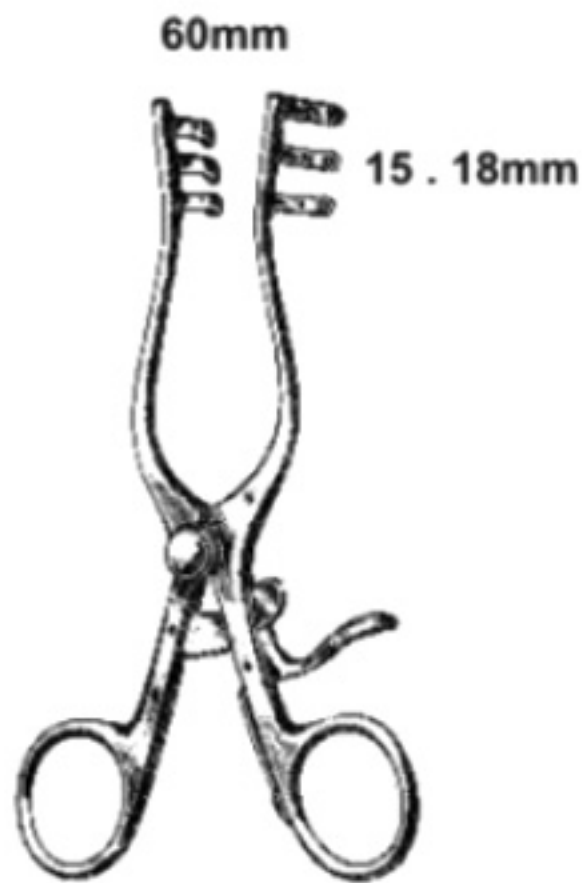

MILLIGAN
21-430 13cm



JANSEN
21-440 10cm



GELPI
21-450 18cm



GENERAL INSTRUMENTS RETRACTORS

◀ 75 mm ▶



MAYO-ADAMS
21-460
21-462 W/CENTRE BLADE



COLLIN
21-470
21-472 W/CENTRE BLADE

◀ 100 mm ▶

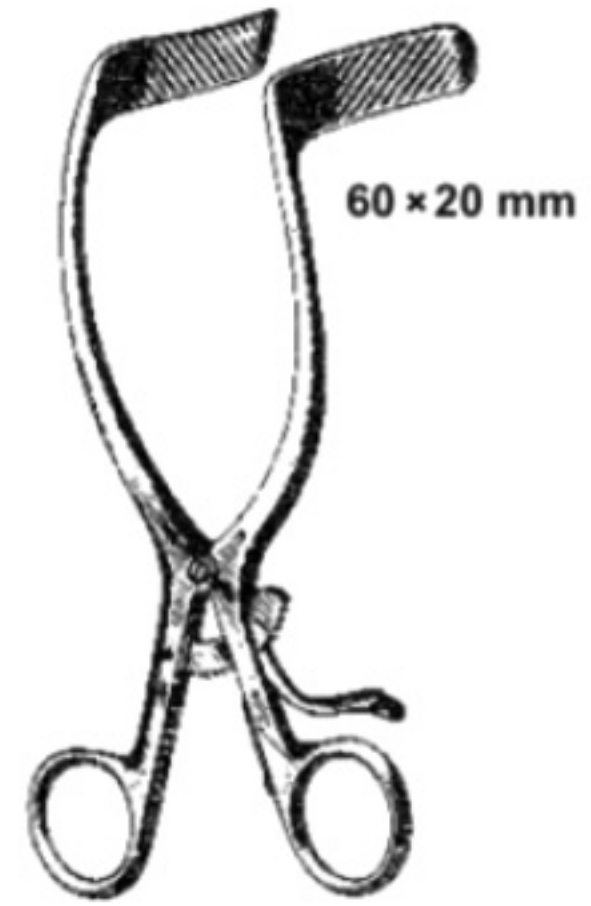

RIGBY
21-480 18cm

◀ 140 mm ▶

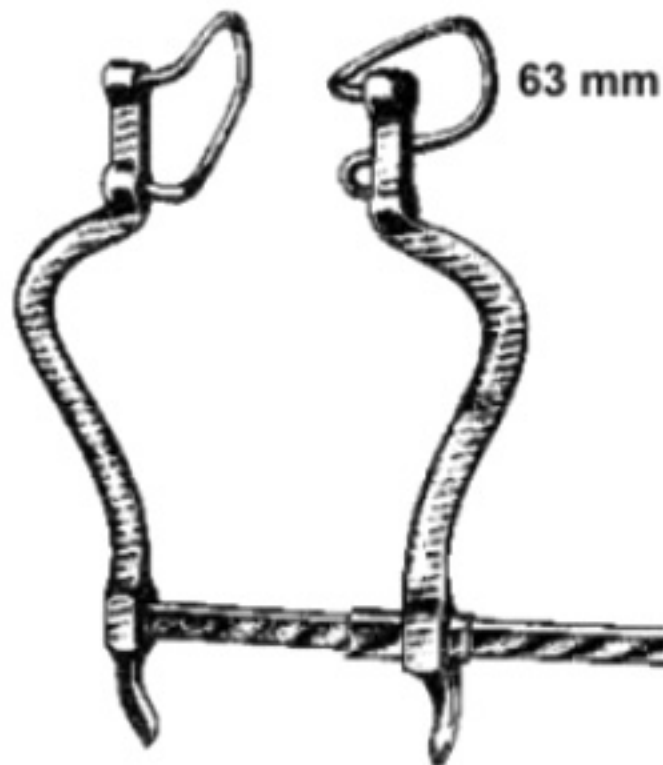

GOSSET
21-490

◀ 180 mm ▶

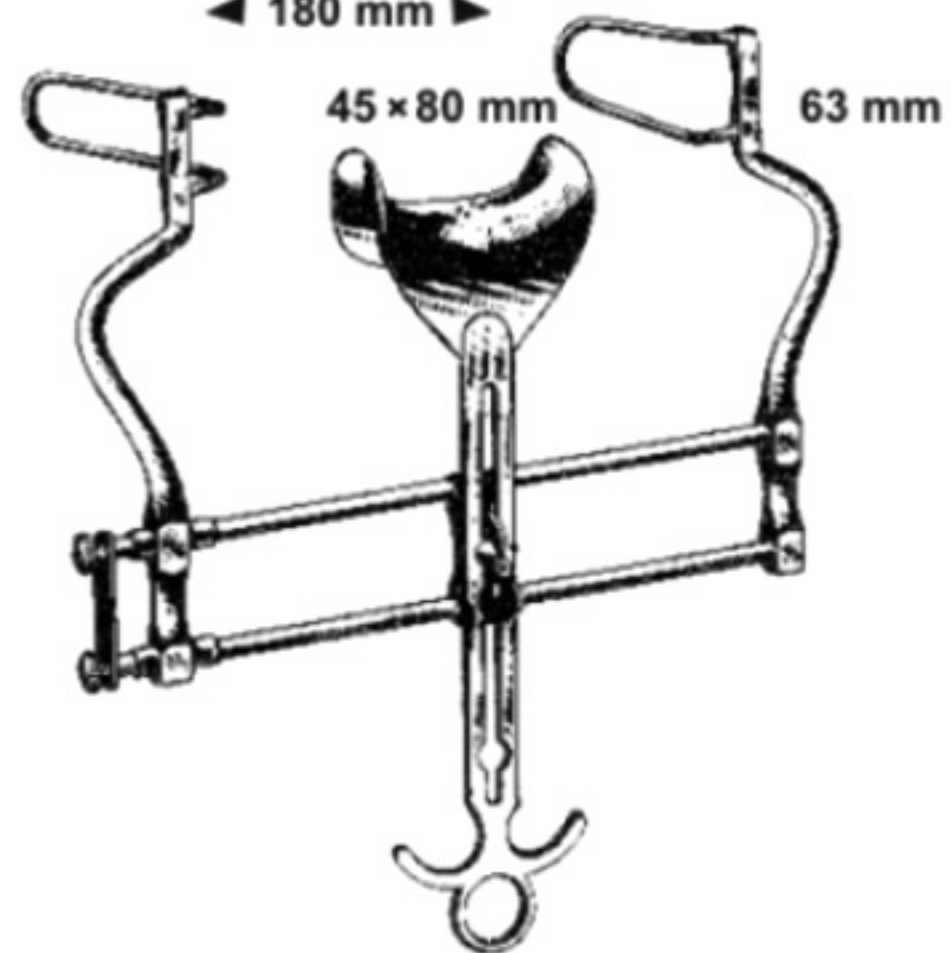

BALFOUR
21-500



GENERAL INSTRUMENTS

PROBES



23-100 11.5cm 23-110 23-120 12.5cm
 23-101 12.5cm 23-111 23-122 14 cm
 23-102 14 cm 23-112 23-124 16 cm
 23-103 16 cm 23-113
 23-104 18 cm 23-114
 23-105 20 cm 23-115
 23-106 25 cm 23-116

DIRECTOR



23-130 12.5cm 23-140
 23-132 14 cm 23-142
 23-134 16 cm 23-144

SAFETY PIN



MAYO
 23-150 14cm

SPATULA



PLASTER
 23-160 13cm
 23-162 16cm

NEEDLES

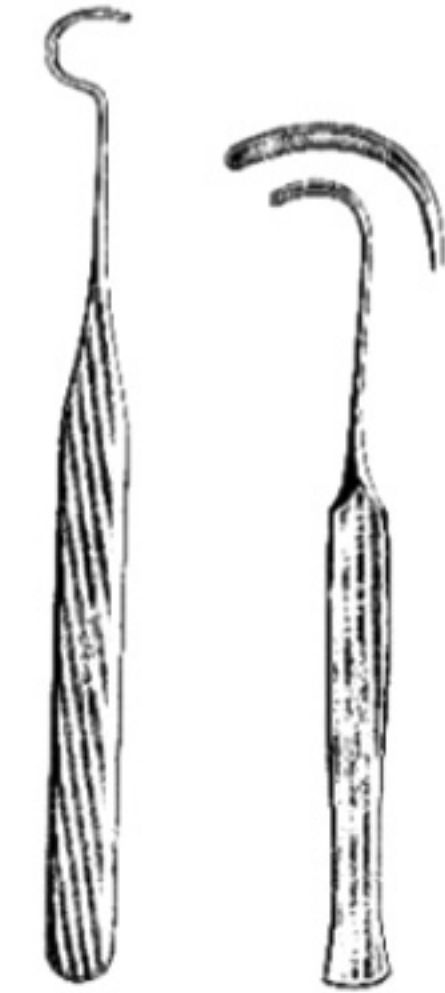

23-170 13cm

SYME
 23-180

DISSECTORS

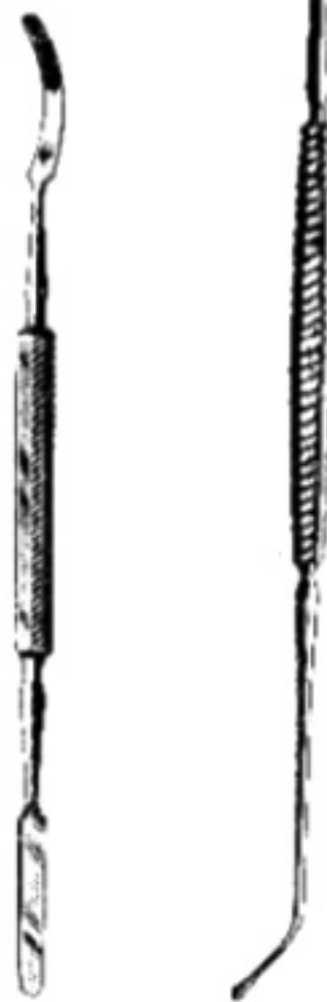

McDONALD
 23-190 19cm

CHEYNE
 23-200 12.5cm
 23-202 17.5cm

APPLICATORS

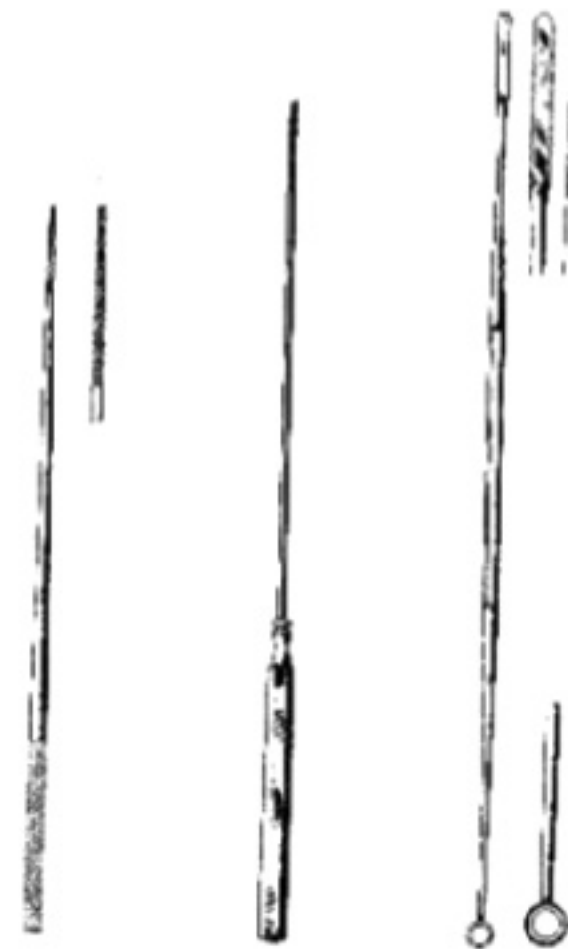

FARRELL
 23-210 12cm 23-220
 23-212 14cm 23-222
 23-214 16cm 23-224
 23-216 18cm 23-226

JOBSON-HORNE
 23-230 12.5cm
 23-232 18 cm



SUTURE NEEDLE HOLDERS



DERF
25-100 12cm

COLLIER
25-110 12.5cm

WEBSTER
25-120 13cm

MAYO HEGAR
25-130 14cm
25-131 16cm
25-132 18cm
25-133 20cm
25-134 24cm
25-135 26cm



CRILE-WOOD
25-140 15cm

CRILE-MURRAY
25-150 15cm

WRIGHT
25-160 13cm

BRUCE-CLARKE
25-170 12.5cm



SUTURE NEEDLE HOLDERS



KILNER
25-180 13.5cm



THOMSON-WALKER
25-190 18cm



BOZEMAN
25-200 20cm



METZENBAUM
25-210 18cm



FINOCHIETTO
25-220 27cm



WANGENSTEEN
25-230 27cm



MASSON
25-240 27cm



SAROT
25-250 18cm
25-252 26cm



SUTURE NEEDLE HOLDERS



OLSEN
25-260 14 cm
25-262 16.5cm
25-264 19 cm



GILLIS
25-270 16cm



MATHIEU
25-280 11cm
25-282 14cm
25-284 17cm

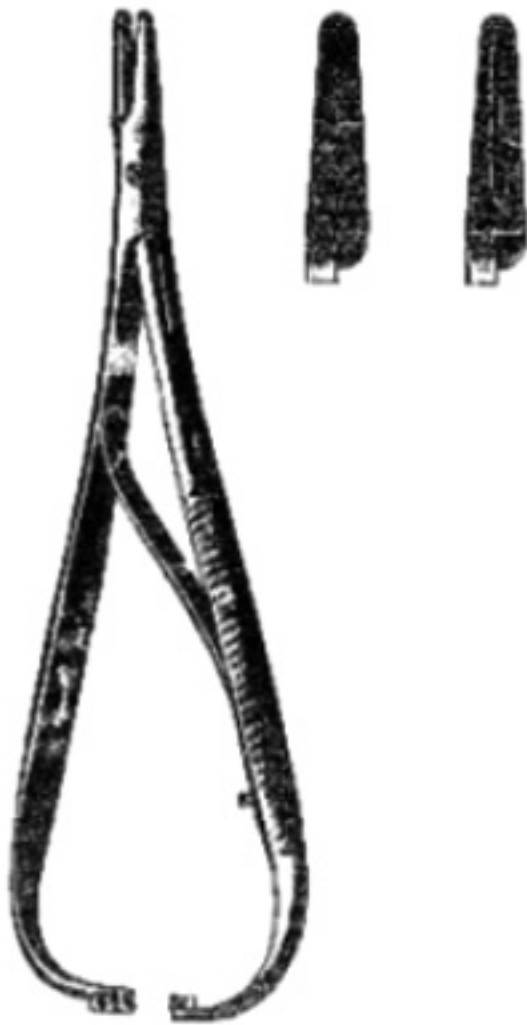

MATHIEU
25-290 14cm
25-292 17cm
25-294 20cm
25-296 24cm



25-300 14cm
25-302 17cm
25-304 20cm
25-306 24cm



LANGENBECK
25-310 16cm
25-312 20cm



CRILE
25-320 15cm



SUTURE NEEDLE HOLDERS

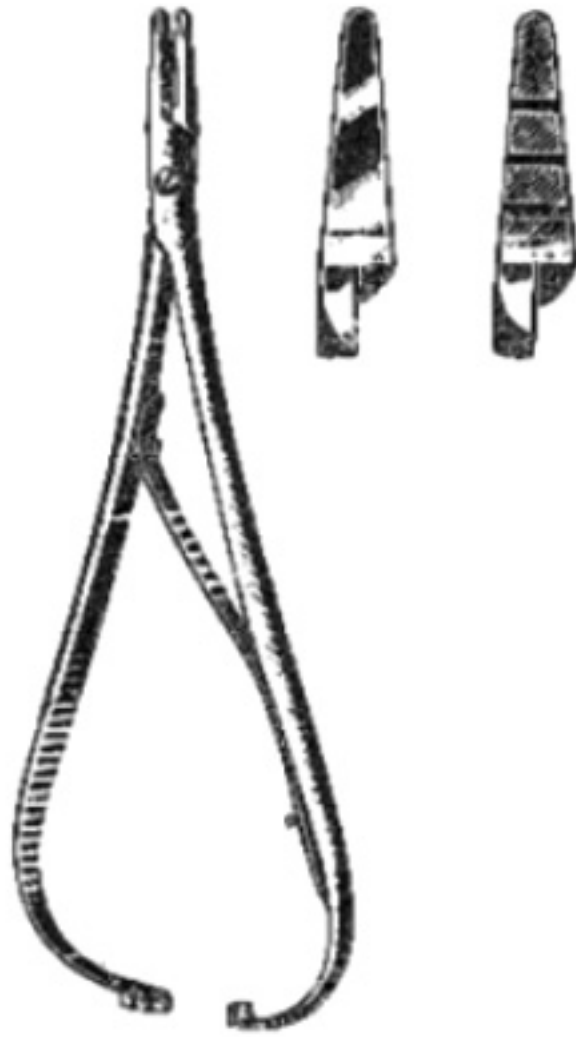

MACPHAIL
25-330 14cm
25-332 16 cm
25-334 18 cm
25-336 20cm



HALSTEAD
25-340 16.5cm
25-342 21 cm
25-344 24 cm



ROCHESTER-MAYO
25-350 18cm
25-352 20cm
25-354 22cm



STEVENS
25-360 13cm

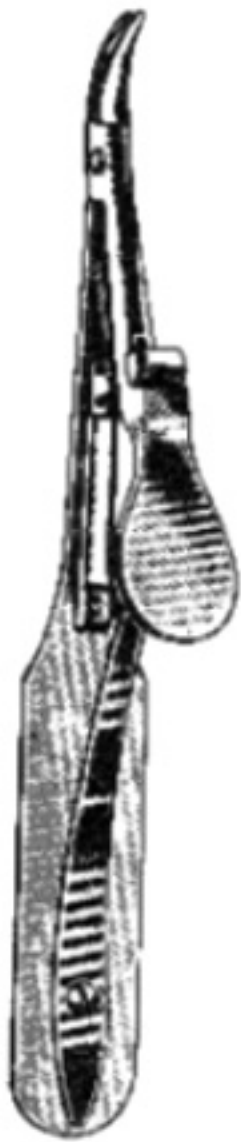

KALT-ARRUGA
25-370 14cm



KALT
25-380 14cm



CASTROVIEJO
25-390 14cm

NEEDLES



DESCHAMPS
25-400 21cm L
25-402 21cm R

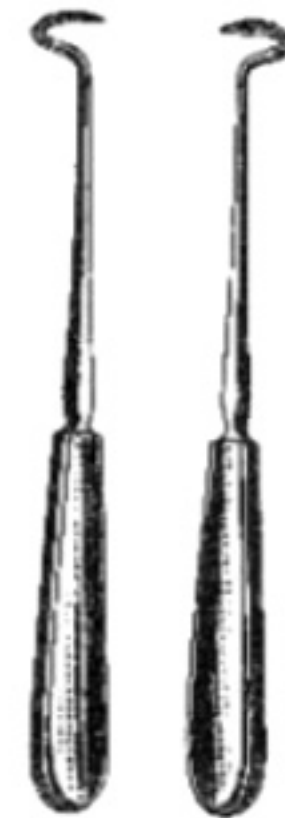

DESCHAMPS
25-410 21cm L
25-412 21cm R



SUTURE NEEDLES



REVERDIN
15cm



Fig. 1
25-420



2
25-422



3
25-424



4
25-426



25-442



25-444



25-446



REVERDIN
19cm



Fig. 1
25-430



2
25-432



3
25-434



4
25-436



YOUNG BOOMRANG
25-440 25cm



SUTURE SUTURE FORCEPS



MICHEL
25-450 12cm



MICHEL
25-460 12cm



WACHENFELDT
25-470 12.5cm



WACHENFELDT
25-480 12.5cm



HEGENBARTH
25-490 12.5cm

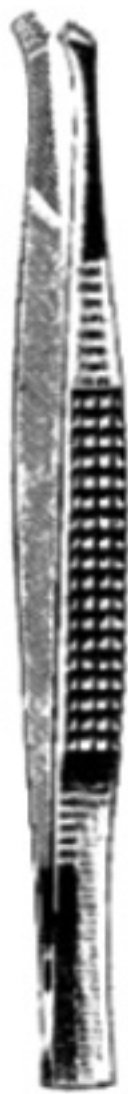

CHILD
25-500 18cm



CHILD
25-510 18cm



RICHTER-HEATH
25-520 14cm



MICHEL
25-530 13cm



MICHEL
25-540 12cm



PLASTER

SCISSORS



LISTER
27-100 9cm
27-102 11cm
27-104 14cm
27-106 18cm
27-108 20cm



KNOWLES
27-120 14cm



ESMARCH
27-130 20cm



SMITH
27-140 16cm
27-142 18cm
27-144 20cm
27-146 23cm

SHEARS

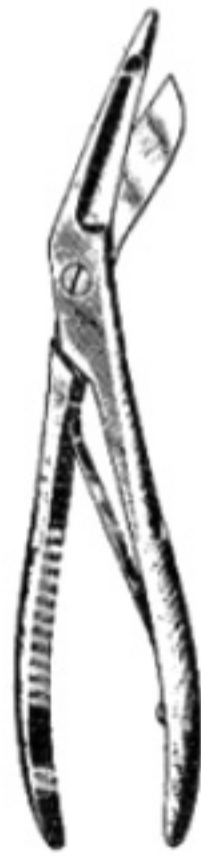

SEUTIN
27-150 23cm



WIRE & CLOTHING
27-160 20cm



BRUNS
27-170 24cm



BRUNS
27-180 24cm



PLASTER

SHEAR



STILLE
27-190 23cm
27-192 26cm
27-194 37cm

SAW

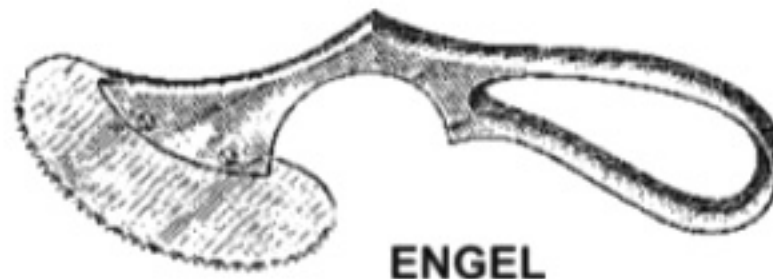

ENGEL
27-200

KNIFE



REINER
27-210 18cm

SPREADER



HENNING
27-240 28cm



BEESON
27-250 30cm

RING CUTTER



FINGER
27-220 16cm

CAST BREAKER



WOLFF
27-230 19cm
27-232 23cm
27-234 26cm



BONE SURGERY

BONE SAWS



CHARRIERE
29-100 27cm
29-102 30cm
29-104 33cm

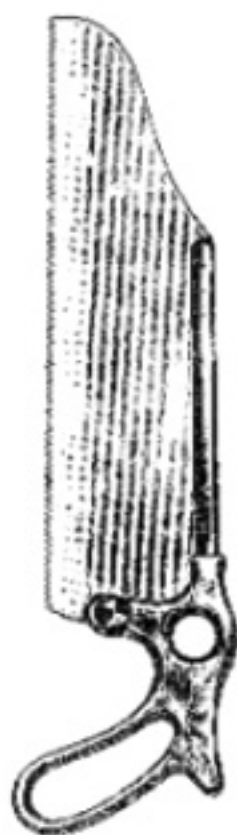

SATTERLEE
29-110 31 cm



POST MORTEN
29-120 20cm Blade



CHARRIERE
29-130 35cm

BONE CHISELS AND GOUGES



OSTEOTOMES
13.5cm
29-140 8mm
29-142 10mm
29-144 12 cm
29-146 14 cm
29-148 16 cm



CHISELS
13.5cm
29-150 8mm
29-152 10mm
29-154 12 cm
29-156 14 cm
29-158 16 cm



GOUGES
13.5cm
29-160
29-162
29-164
29-166
29-168



STILLE
20CM
29-170 10mm
29-172 15mm
29-174 20mm
29-176 25mm



STILLE
20CM
29-180 10mm
29-182 15mm
29-184 20mm
29-186 25mm



STILLE
20CM
29-190
29-192
29-194
29-196



BONE SURGERY BONEMALLETS

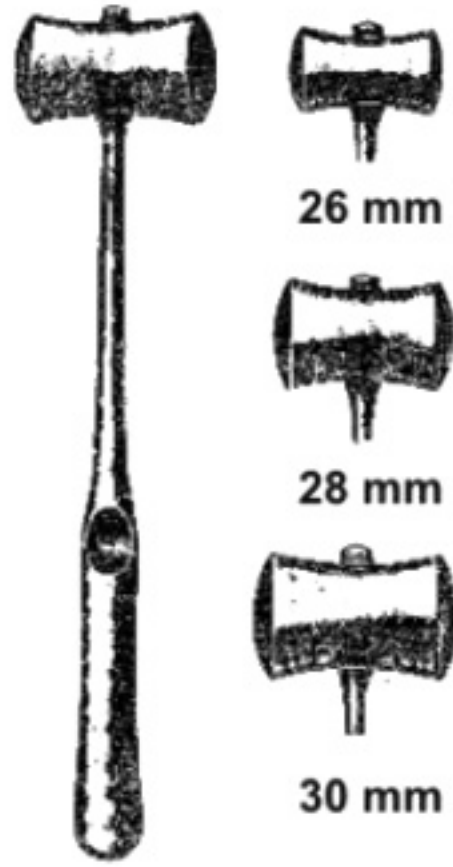

WILLIGER
29-200 24cm

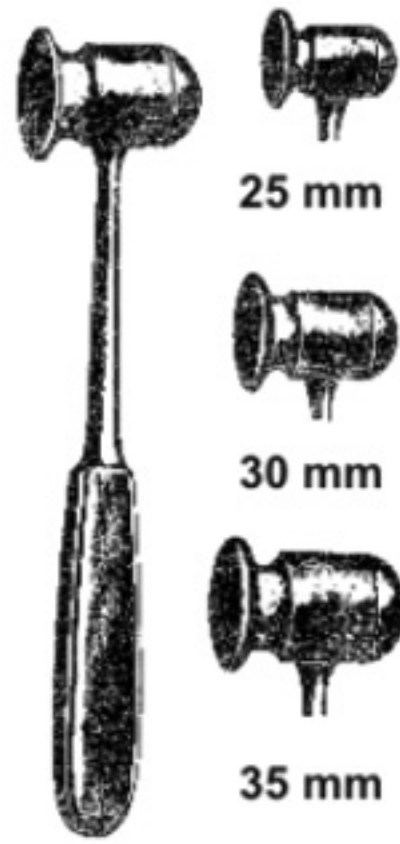

DOYEN
29-210 21cm



COLLIN
29-220 20cm



HEATH
29-230 18cm

BONE SPOONS

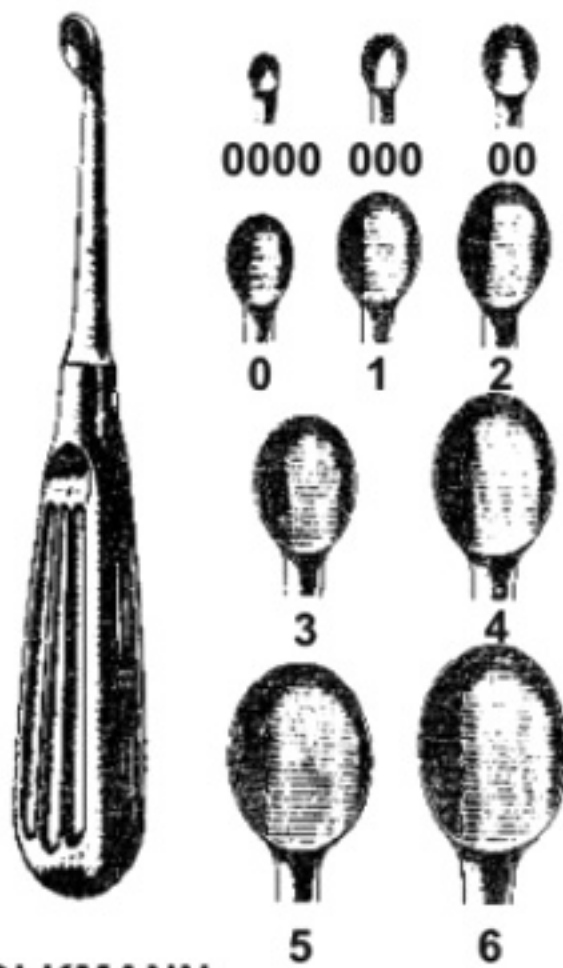

VOLKMANN
29-240
0000 To 6

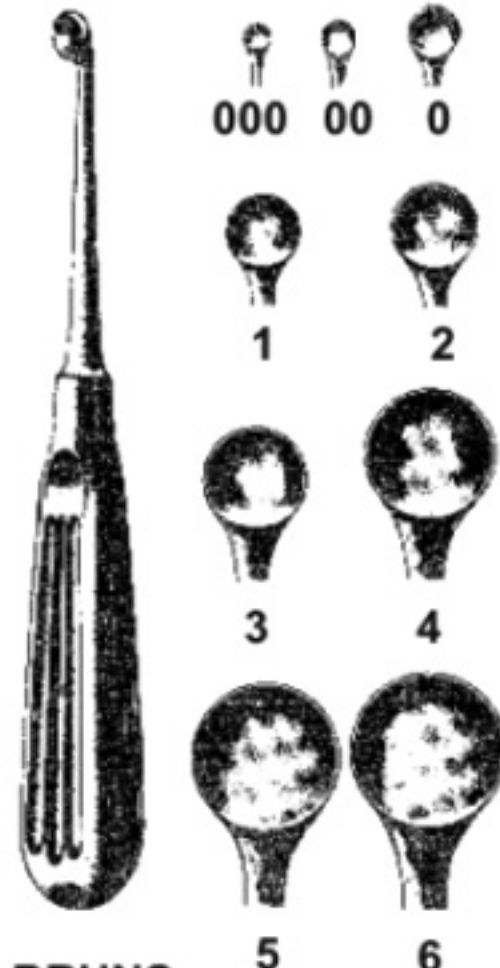

BRUNS
29-250
0000 To 6



VOLKMANN
29-260 13cm
29-262 16.5cm
29-264 20cm



VOLKMANN
29-270
29-272
29-274



BONE SURGERY

RASPATORIES



FARABEUF
29-280 15cm 29-290

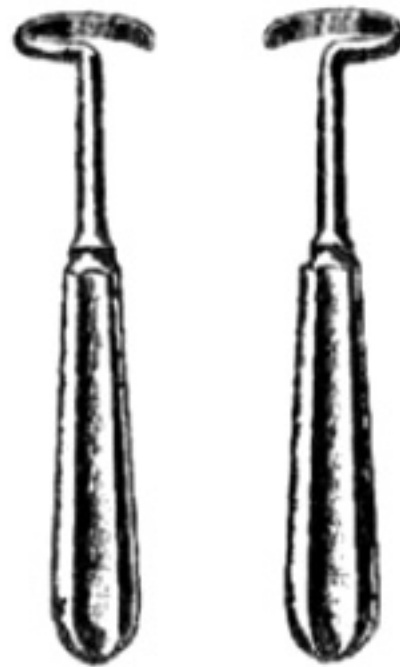

DOYEN
17cm
29-300L ADULT 29-302 R
29-310L CHILD 29-312 R

ELEVATORS

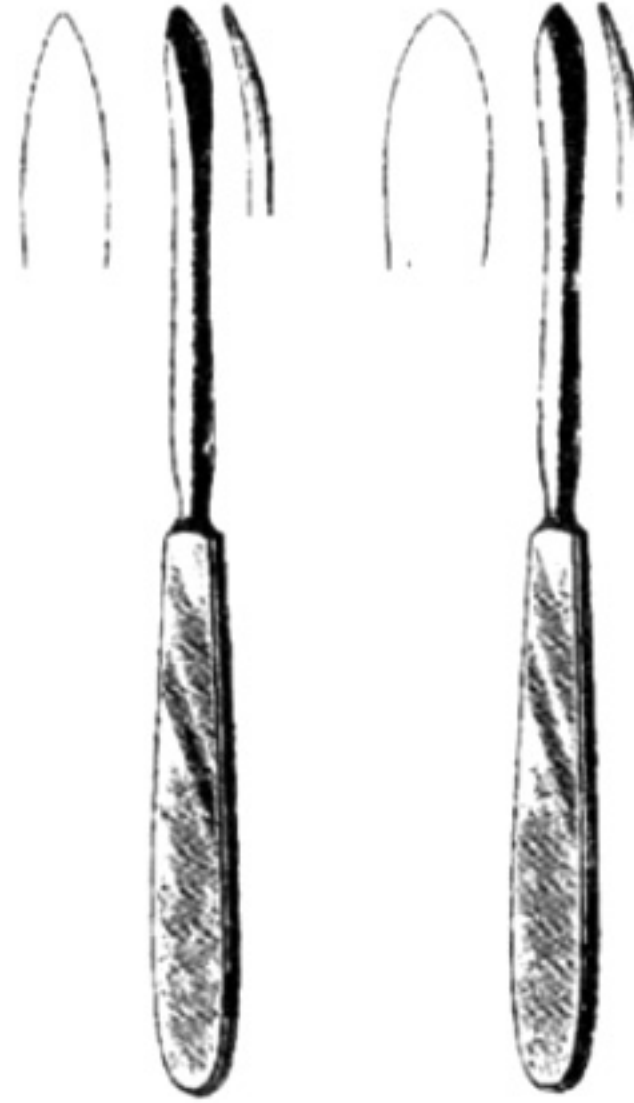

LANGENBECK
29-320 20cm 29-330

ELEVATORS



WILLIGER
29-340 17cm 29-350 16cm

RASPATORIES



SEMB
29-360 29-361 29-362 29-363 29-364 29-365 29-366



BONE SURGERY

LEVERS



LANGE-HOHMANN
 29-370 27cm 29-380
 29-372 29cm 29-382

LEVERS AND FORCEPS

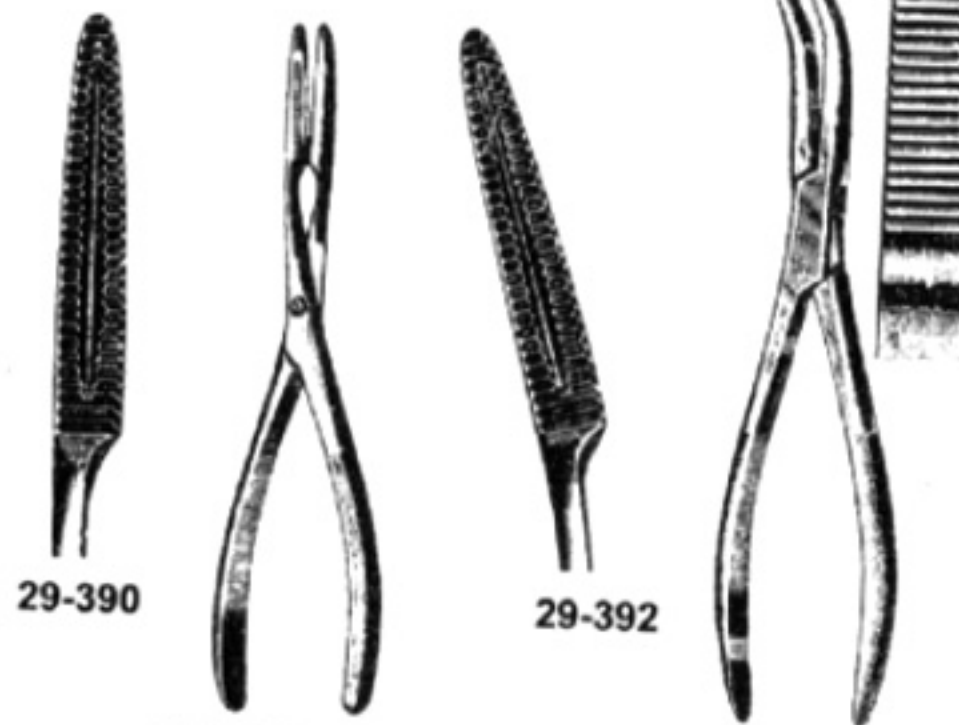

SEQUESTRUM
 29-390 20cm
 29-392 20cm

VAN BUREN
 29-400 23cm

BONE HOLDING FORCEPS

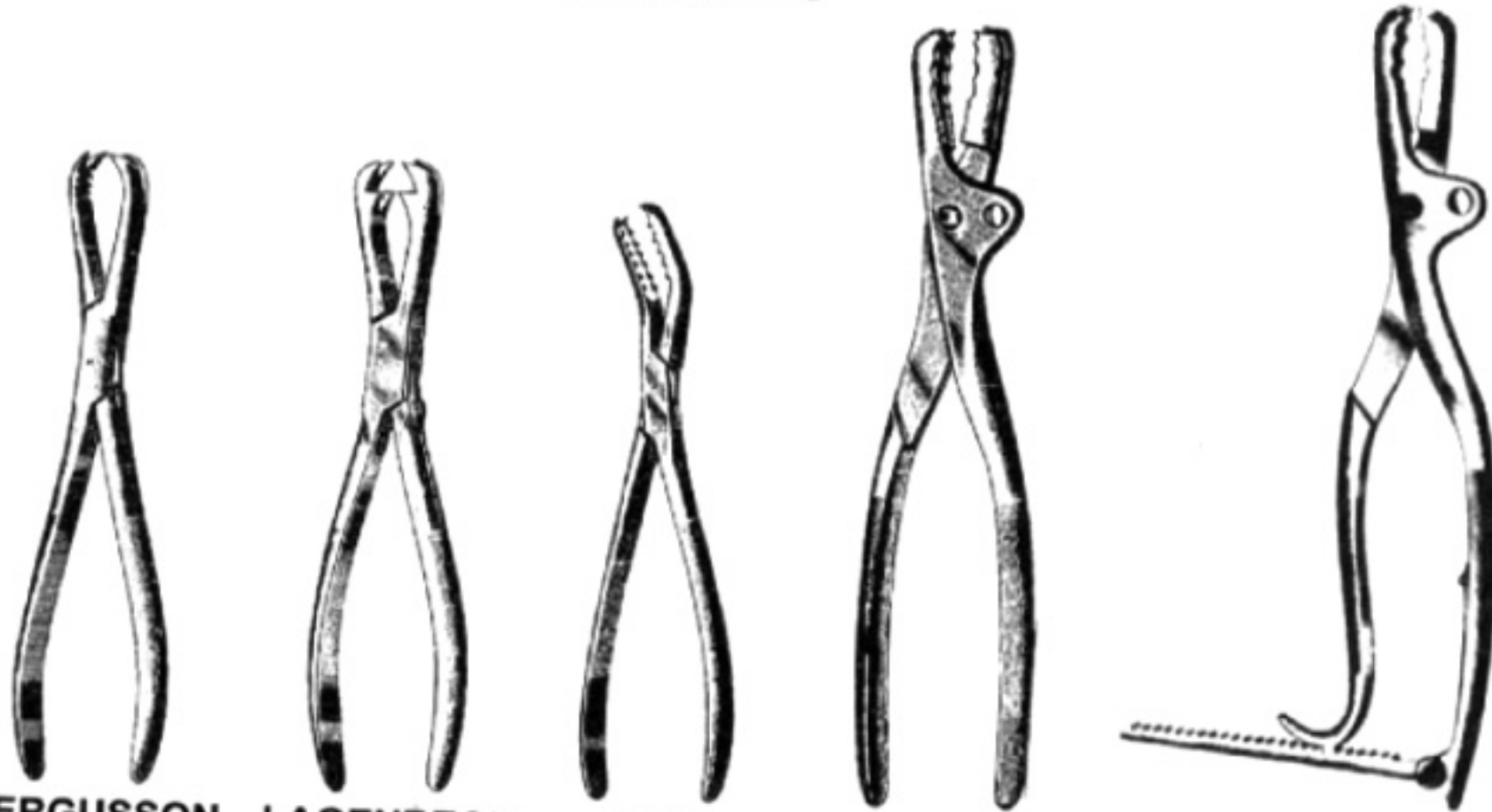

FERGUSSON
 29-405 21cm

LAGENBECK
 29-410 21cm

SEMB
 29-420 19cm

FARABEUF
 29-430 23cm
 29-432 26cm

FARABEUF-LAMBOTTE
 22-440 26cm



BONE SURGERY

BONE HOLDING FORCEPS



LANE
29-450 31.5cm
29-452 39cm



LANE
29-460 33cm
29-462 45cm



KERN
29-470 17cm
29-472 21cm



KERN
29-480 17cm
29-482 21cm



LAMBOTTE
29-490 19cm
29-492 23cm
29-494 26cm



LAMBOTTE
29-500 22cm
29-502 26cm
29-504 33cm



BONE SURGERY

BONE RONGER

RETRACTOR



PERCY
29-510

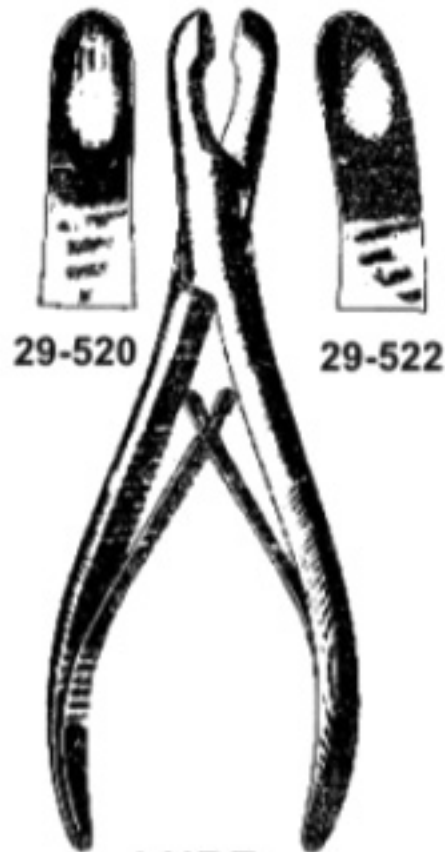

LURE
29-520 17cm
29-522 17cm



LEMPERT
29-530 19cm



STILLE-LUER
29-540 22cm



LEKSELL-STILLE
29-550 24cm



RUSKIN
29-560 18cm



BONE SURGERY

BONE RONGEUR



HARTMAN
29-570 18.5cm



29-580

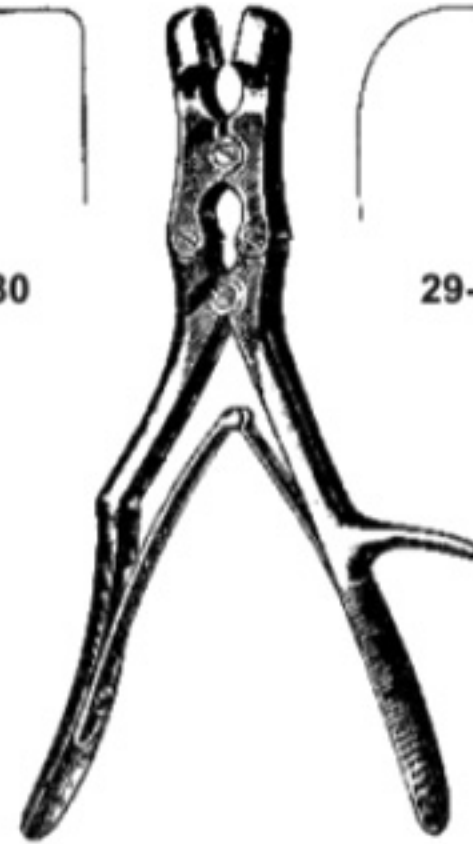

SAUERBRUCH
29-580 30cm
29-582 30cm



29-582



LISTON-KEY
29-590 27cm

BONE CUTTING FORCEPS



29-600

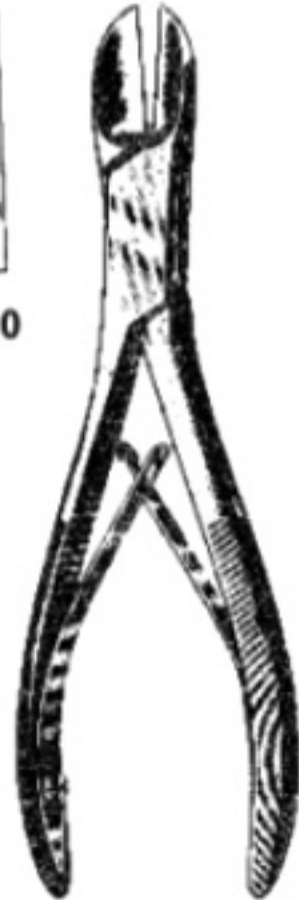

LISTON STR
29-600 14cm
29-602 17cm
29-604 19cm
29-606 22cm



29-610



RUSKIN-LISTON
29-620 18cm
29-622 18cm



29-622



STILLE-LISTON
29-630 27cm
29-632 27cm



29-632



LUNG SURGERY

RIB SHEARS



31-100 20cm
31-102 23cm



COLLIN
31-120 19cm



DOYEN
31-130 19cm

RIB SHEARS



BRUNNER
31-140 28cm



GIERTZ-STILLE
31-150 36cm

SPREADER

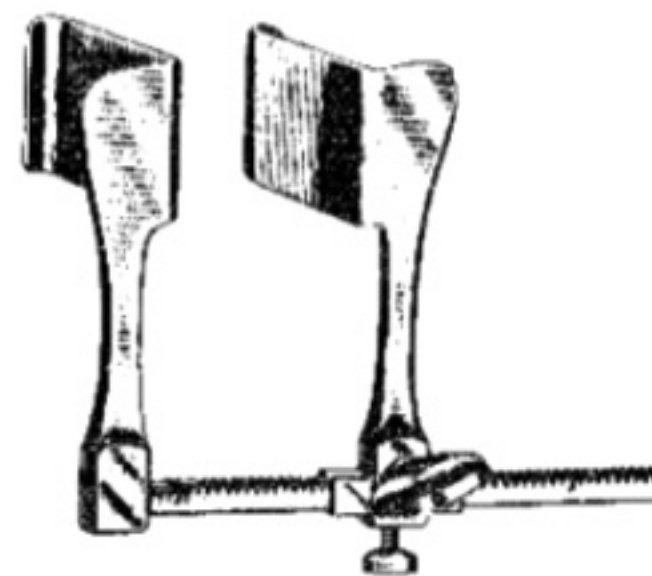

TUFFER
31-160



CARDIOVASCULAR

BRONCHUS

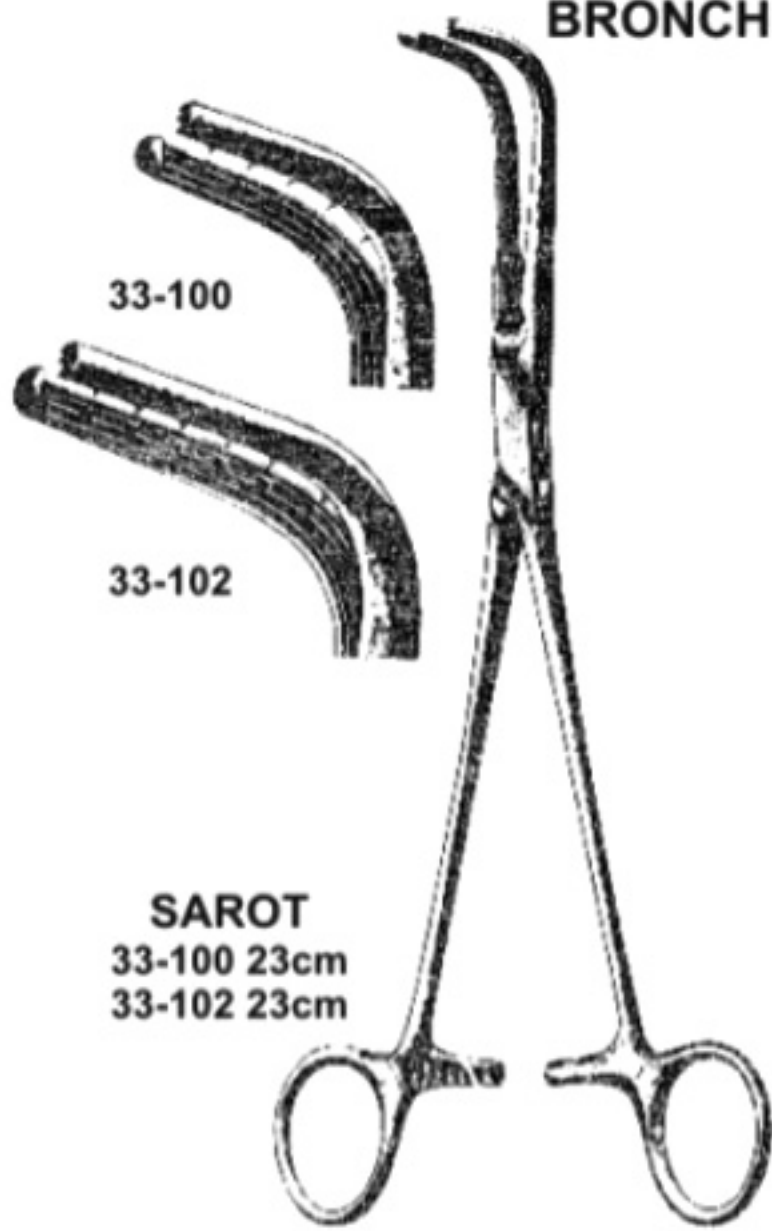

ANASTOMOSIS

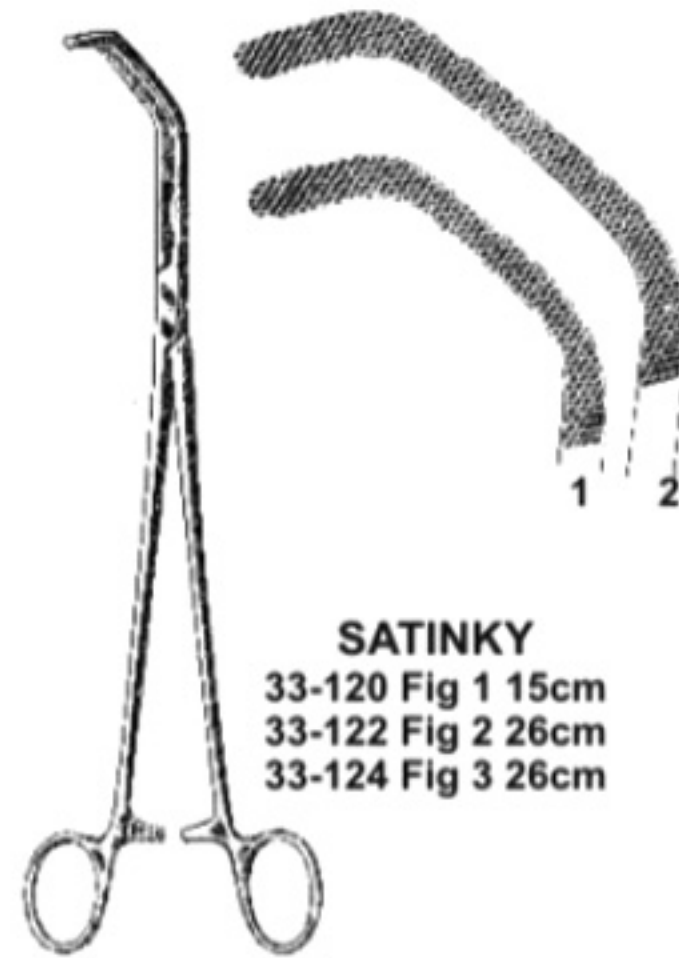

ANASTOMOSIS

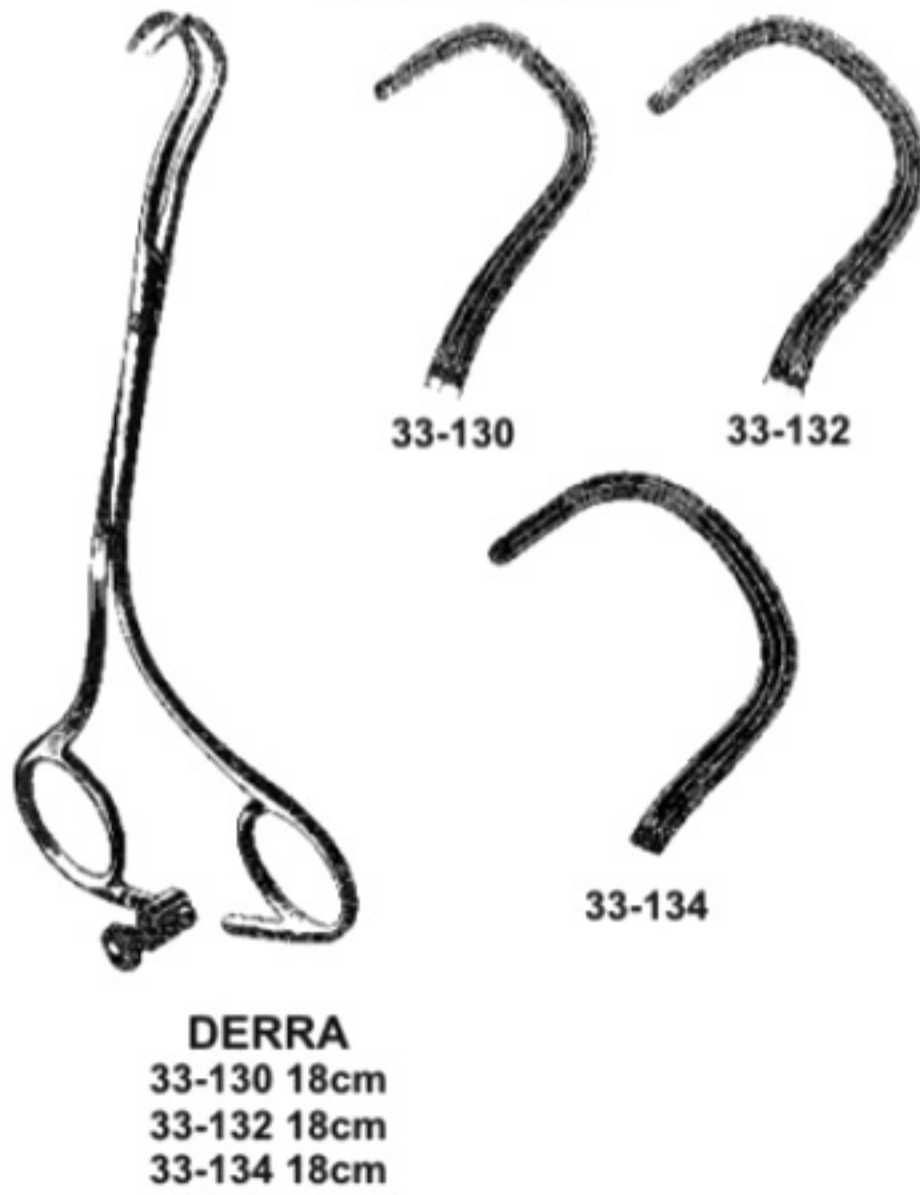

BRONCHUS

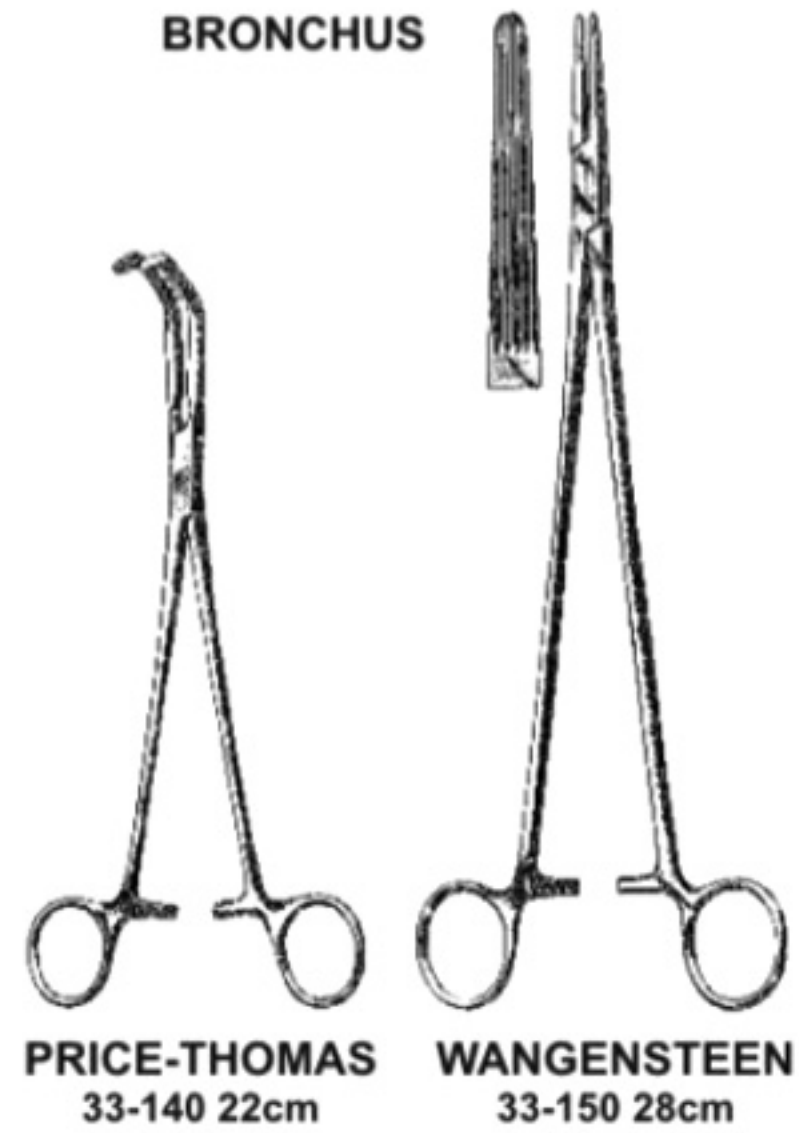



CARDIOVASCULAR

LUNG GRASPING



LOVELACE
33-160 20cm



LOVELACE
33-170 20cm



**HARRINGTON
ROCHESTER**
33-180 30cm



DAVIDSON
33-190 23cm

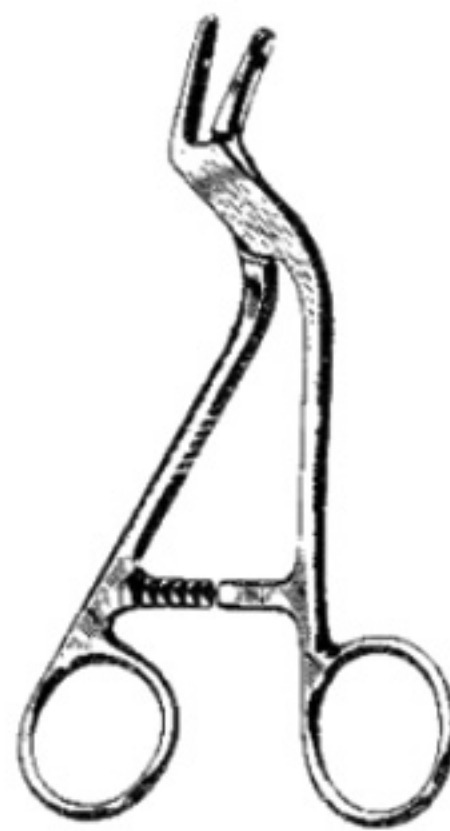

ADSON
33-200 15cm



BLALOCK
33-210 15cm
33-212 20cm
33-214 20cm



33-210



33-212

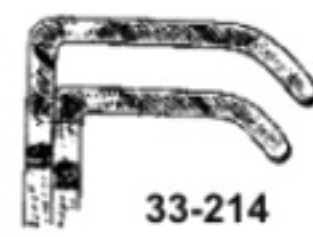

33-214



NEUROSURGERY

BRAIN CLAMPS



MCKENZIE
35-100 15cm
35-102 19cm

SUCTION CANNULA



FRAZIER
17cm
35-110 6ch.G.
35-112 8ch.G.
35-114 10ch.G.
35-116 12ch.G.



FRAZIER
35-120 13cm
35-122 17cm

NERVE HOOK



GRAHAM 35-130 16.5cm
SACHS 35-140 16.5cm

LAMINECTOMY RONGEURS

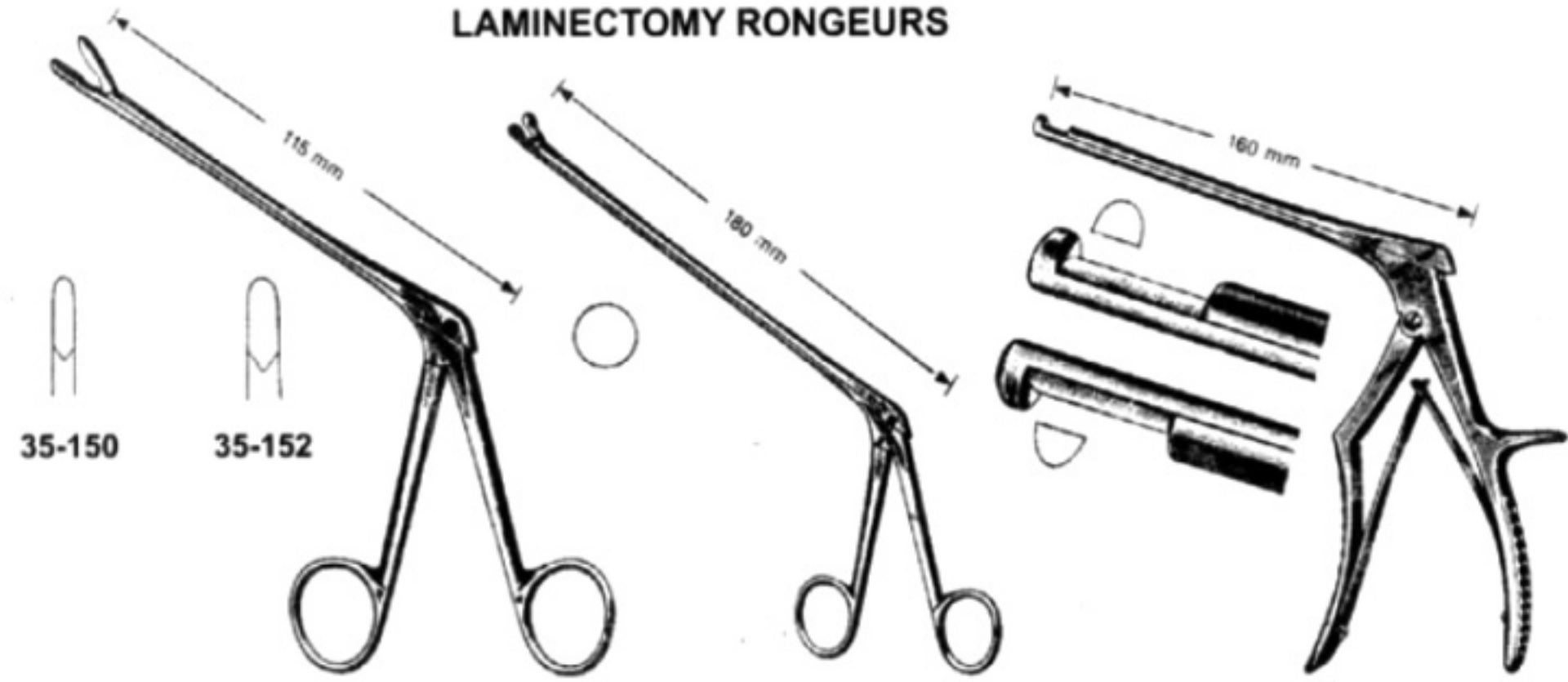

35-150

35-152

SPURLING-LOVE
35-150 28cm
35-152 28cm

OLDBERG
35-160 25cm

COLCLOUGH
35-170 27cm UP CUTTING
35-172 27cm DOWN CUTTING



OPHTHALMOLOGY EYE SPECULA



BOWMAN
37-100 7cm



CRITCHETT
37-120 6cm



SMITH
37-130 5cm



CLARKE
37-140 8cm



GRAEFE
37-150 6cm
37-152 9cm



ARRUGA
37-160 7cm L
37-162 7cm R



MELLINGER
37-170 7cm



MUELLER
37-180 7cm



DESMARRES
37-190 12mm
37-192 14mm
37-194 16mm
37-196 18mm



12mm

37-190



14mm

37-192



16mm

37-194



18mm

37-196



OPHTHALMOLOGY

SCALPELS

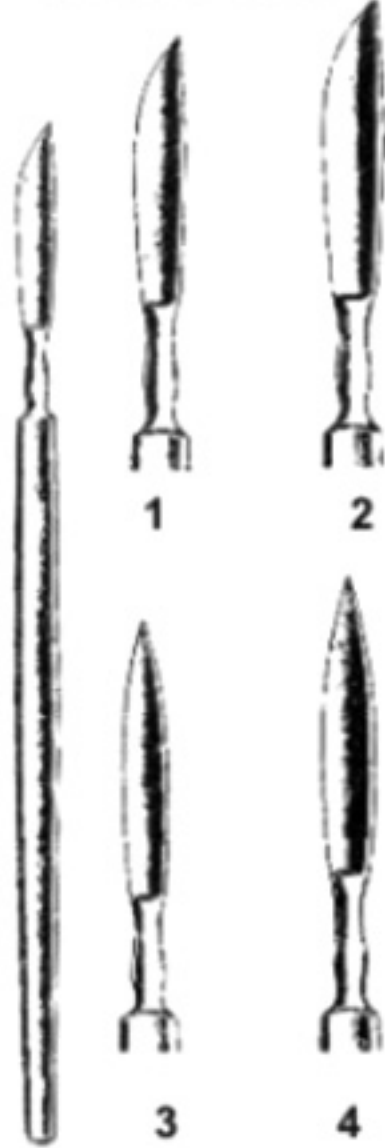

37-200 Fig 1
37-202 Fig 2
37-204 Fig 3
37-206 Fig 4



BEER
37-220 Fig 1
37-222 Fig 2

KNIVES

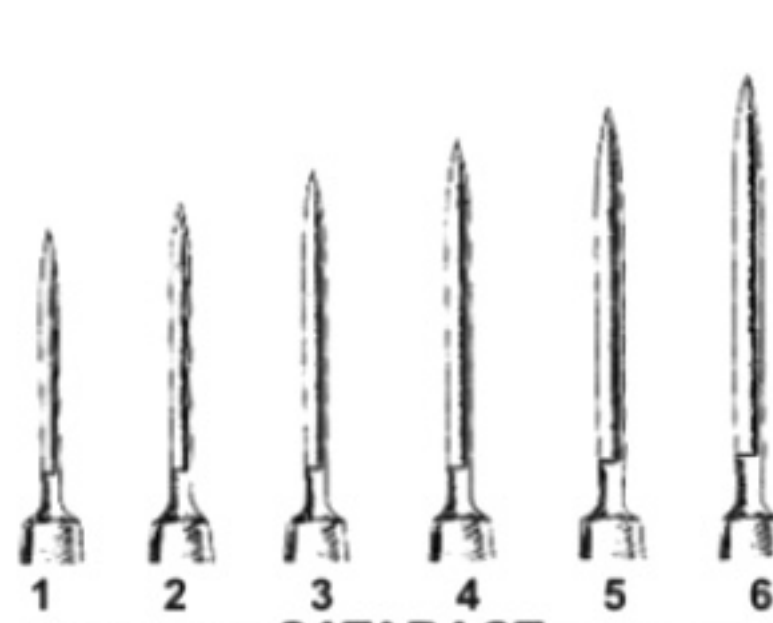

CATARACT

37-210 Fig 1
37-211 Fig 2
37-212 Fig 3
37-213 Fig 4
37-214 Fig 5
37-215 Fig 6



JAEGER

37-230 37-232 37-234 37-236



JAEGER

37-240 37-242 37-244 37-246



OPHTHALMOLOGY

KNIVES

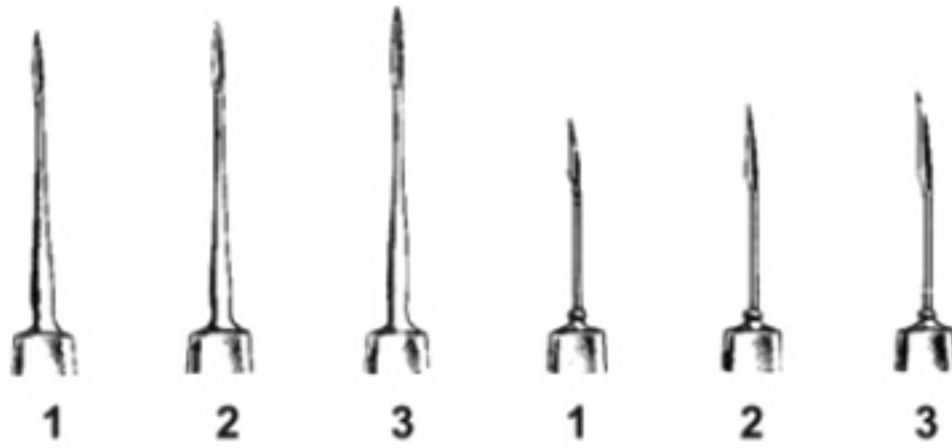

KNAPP
37-250 Fig 1
37-252 Fig 2
37-254 Fig 3

ZIEGLER
37-260 Fig 1
37-262 Fig 2
37-264 Fig 3

NEEDLES

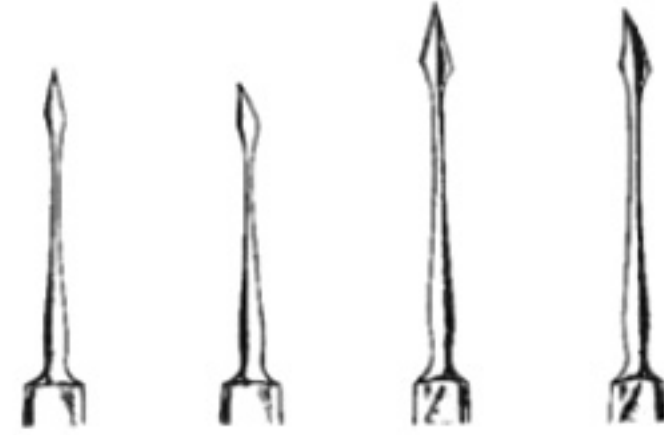

CATARACT **FOREIGN BODY**
37-270 37-272 37-280 37-282

CYSTOTOMES



BOWMANN
37-290 37-292

37-300

GRAEFE
37-302 37-304

HOOKS



GRAEFE
37-310 37-312

GUTHRIE
37-320 37-322

SCOOPS



WEBER
37-330 37-332

SNELLEN
37-340

SPOONS



DAVIEL
37-350 37-352

RETRACTORS



ROLLET
37-360

KNAPP
37-370



OPHTHALMOLOGY

HOOKS

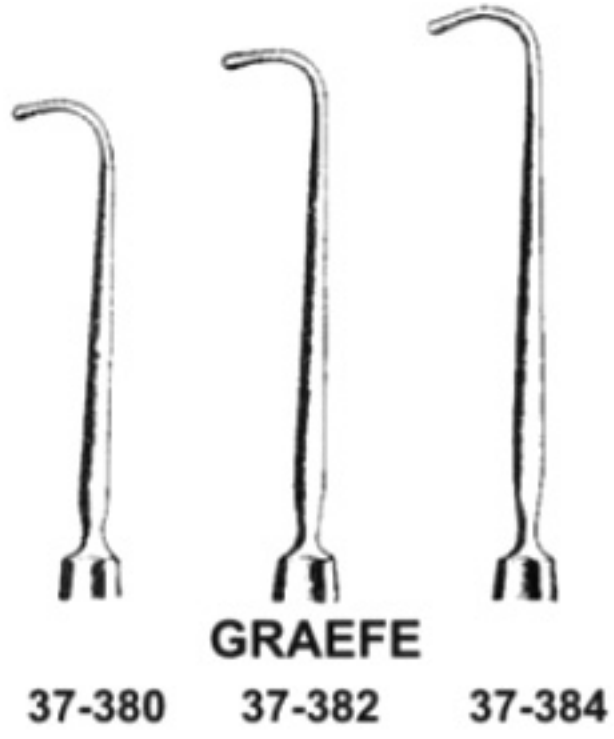

SCOOP



SPATULAS

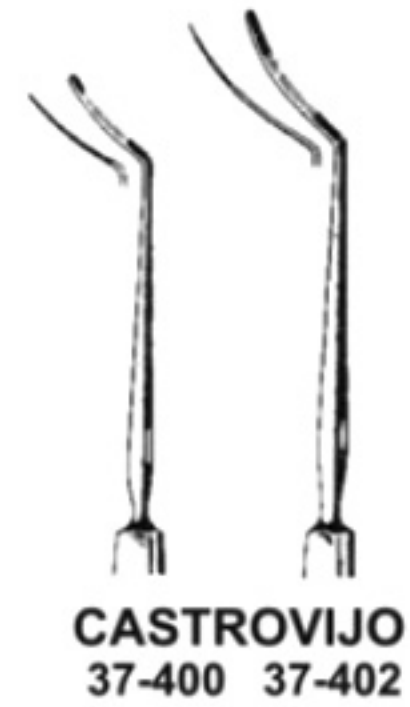

CURETTES

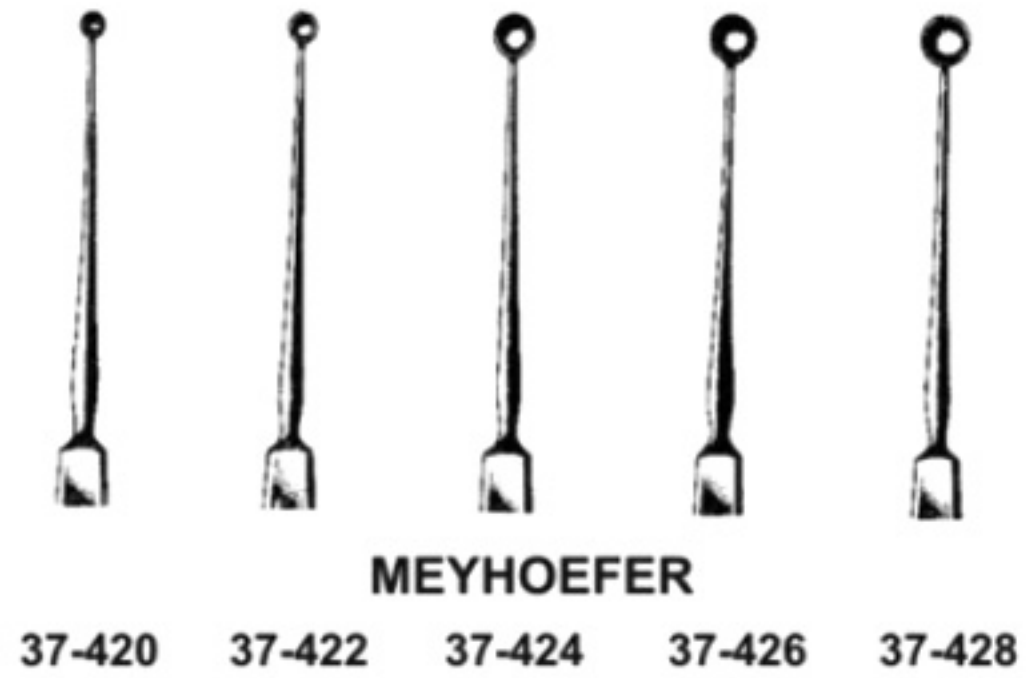
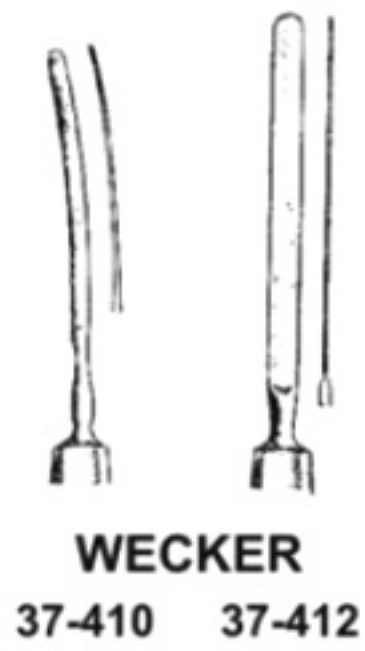

CHISEL



FOREIGN BODY

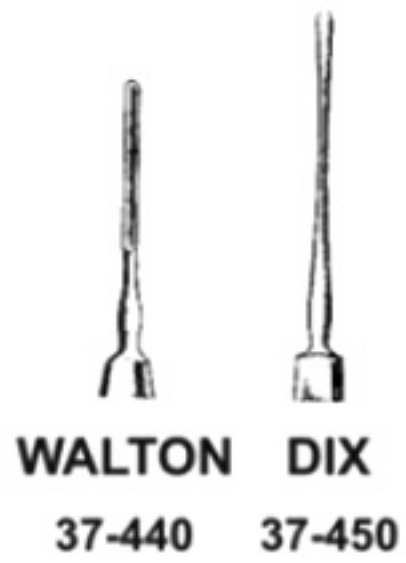

37-460

JAEGER

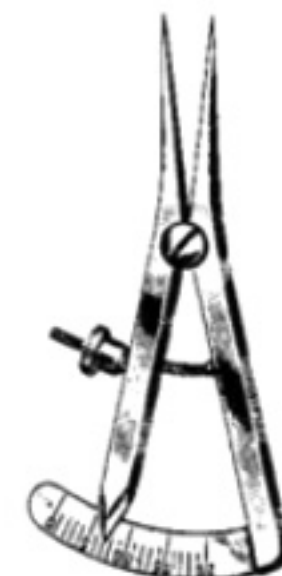

37-470

CASTROVIJO



OPHTHALMOLOGY

DIALTORS



WILDER
37-480 Fig 1
37-482 Fig 2
37-484 Fig 3

PROBES

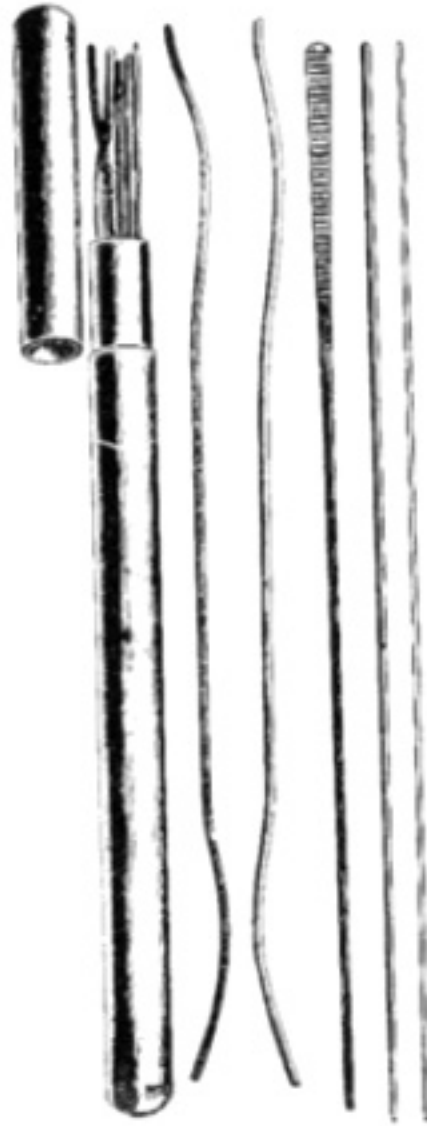

BOWMAN
37-490 SET

DISSECTOR SPATULAS

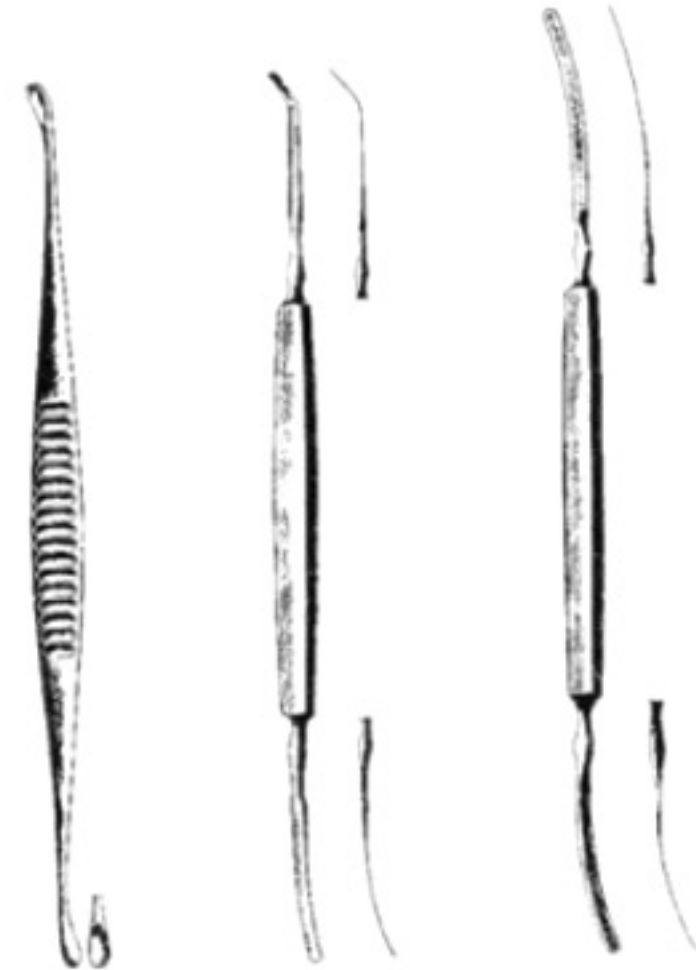

AXENFELD
37-500

WHEELER
37-510

SMITH-FISHER
37-520



37-530



37-540



MEYHOEFER

37-550



37-560



37-570



37-580



37-590



37-600



OPHTHALMOLOGY

IRIS FORCEPS

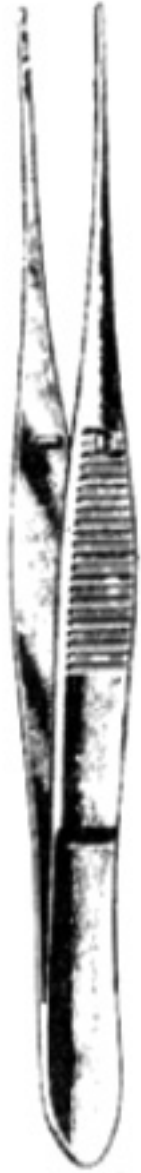

GRAEFE



37-610



37-611



37-612



1:2

37-613



1:2

37-614



1:2

37-615



STR
37-620



GRAEFE

CUR
37-622

SERRATED 1:2
37-610 10cm 37-613
37-611 10cm 37-614
37-612 10cm 37-615



1:2

STR
37-630

GRAEFE

7cm



1:2

CUR
37-632



BISHOP-HARMAN

SERRATED

37-640



1:2

37-642



1:2

37-670

HESS

7cm



1:2

37-680

37-630 7cm 37-632

37-640 8.5cm 37-642

37-670 7cm 37-680



OPHTHALMOLOGY



1:2
37-690 9cm



1:2
37-700

IRIS FORCEPS



1:2
37-710 7cm



1:2
37-720



ARRUGA
37-730 9.5cm



ELSCHING
37-740 10cm



HESS
37-750 6.5cm

CAPSULAR FORCEPS



37-760 6cm



FUCHS
37-770 7cm



HESS
37-780 6cm

FIXATION FORCEPS



1:2
ELSCHING
37-790 11cm



GRAEFE
37-800 11cm



GRAEFE
37-810 11cm



SCHMIDT-RIMPLEX
37-820 11cm



OPHTHALMOLOGY SUTURES AND CHALAZIAN FORCEPS

SUTURE FORCEPS

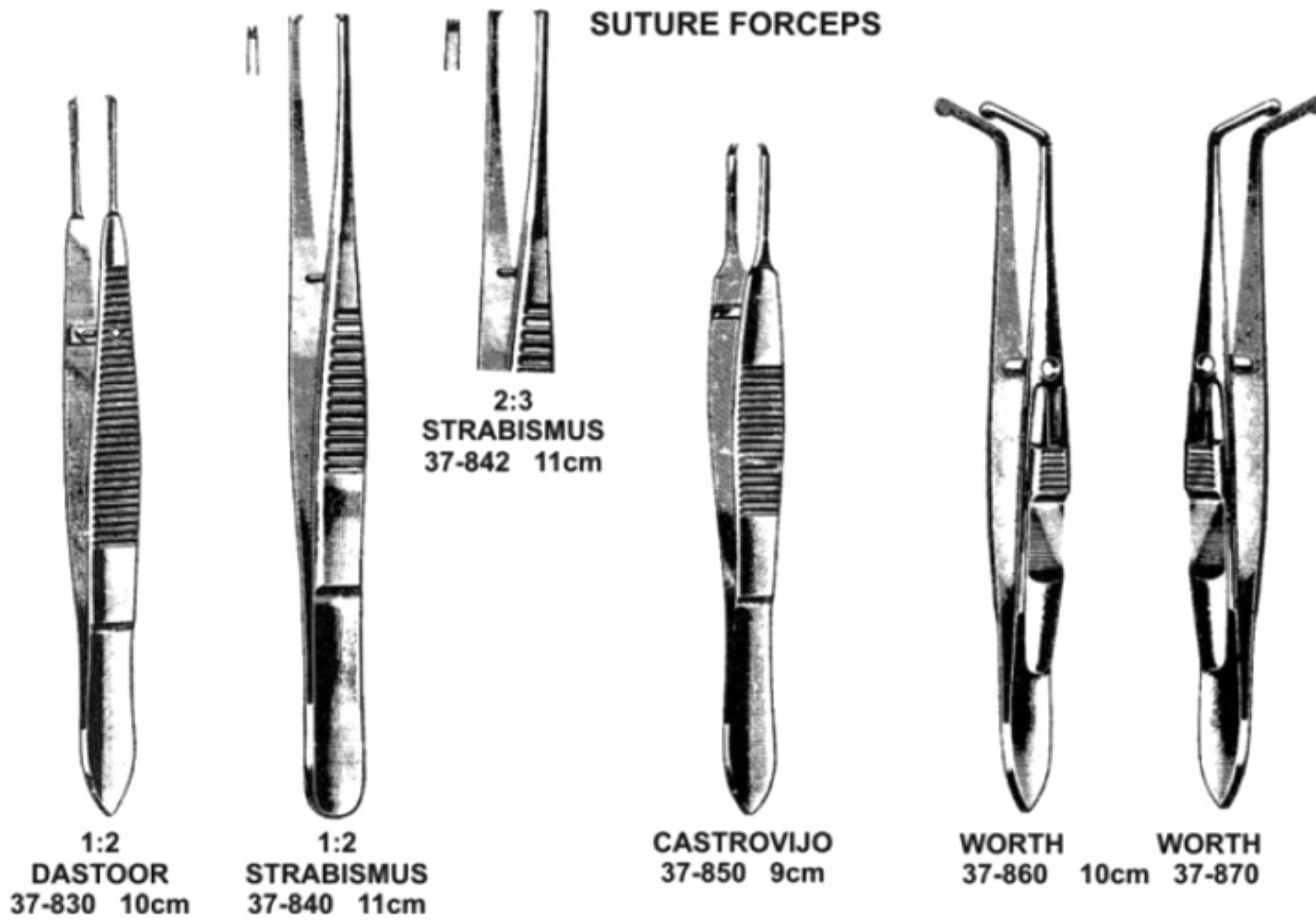

CHALAZIAN FORCEPS

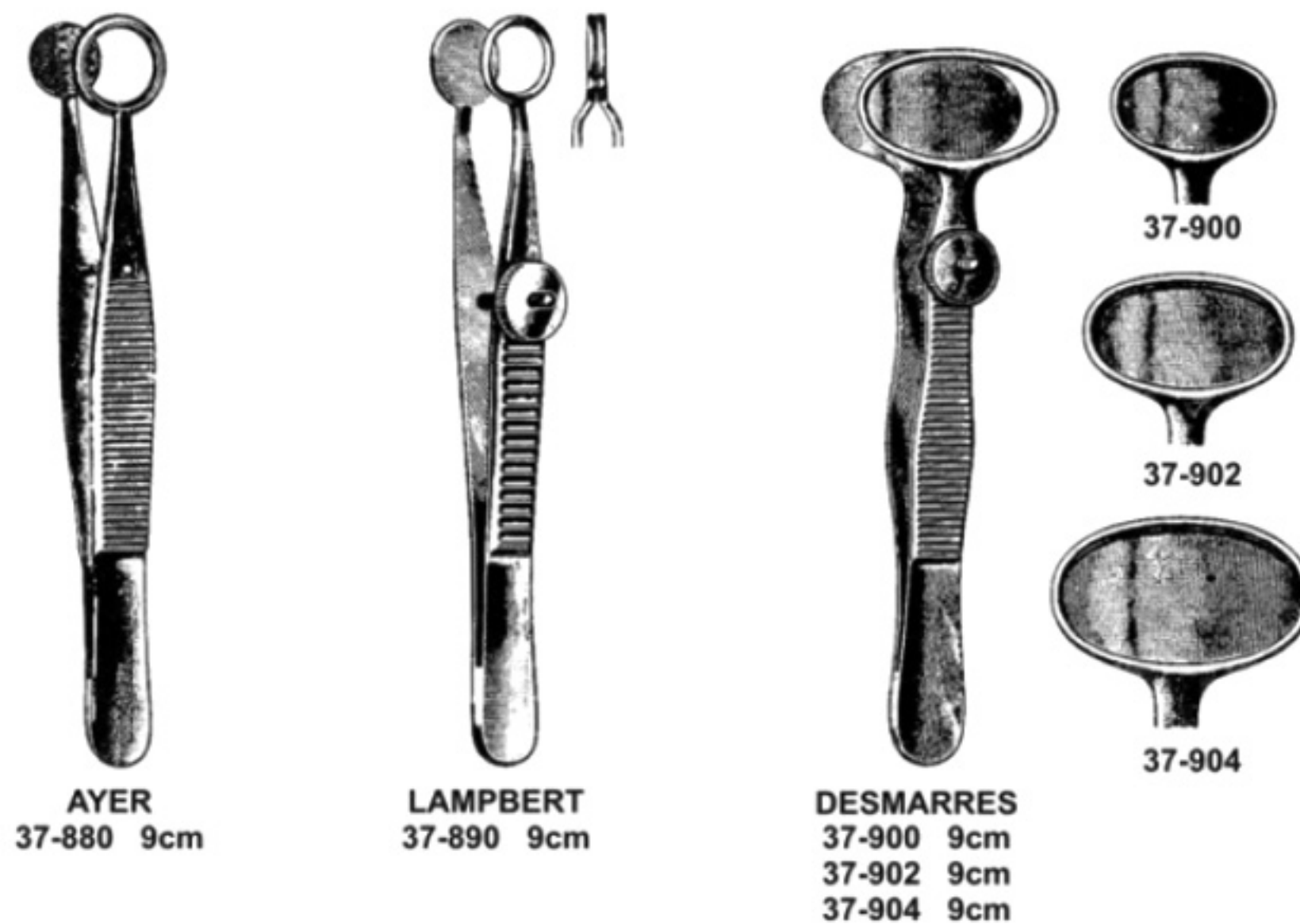



OPHTHALMOLOGY

ENTROPIUM FORCEPS



SNELLEN
37-910 R
37-912 L

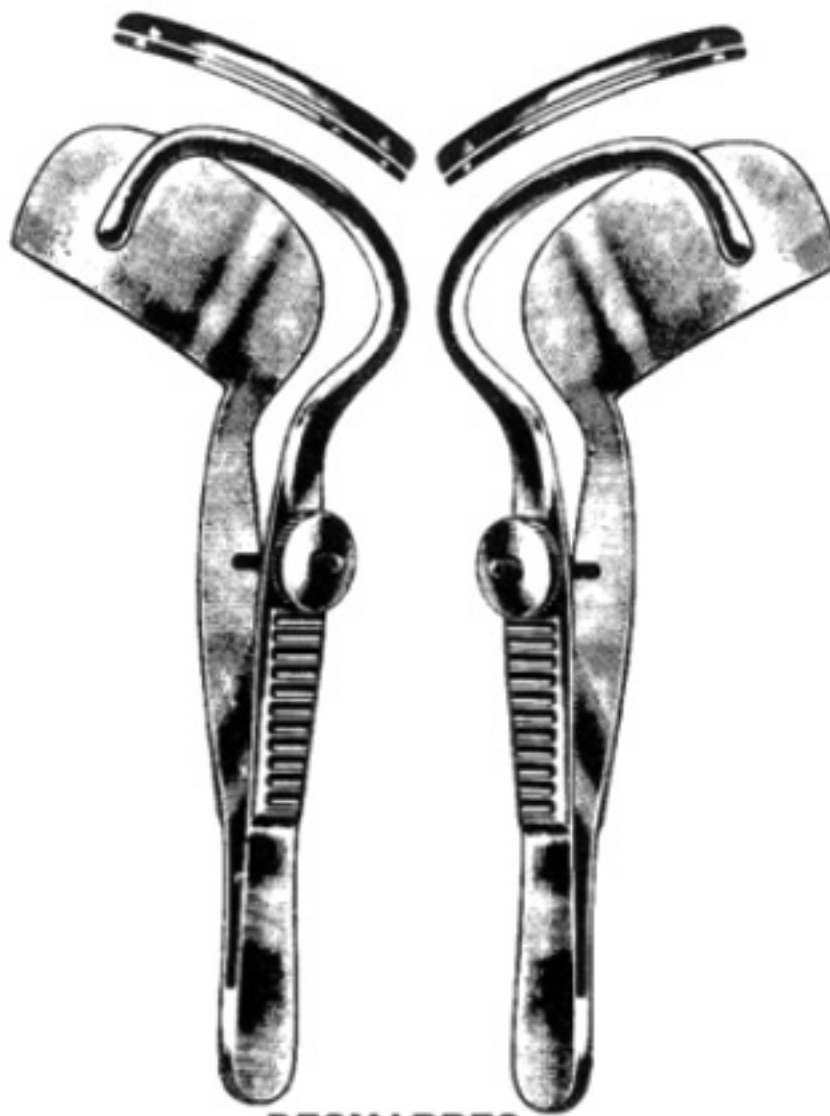

DESMARRES
37-920 10cm 37-922

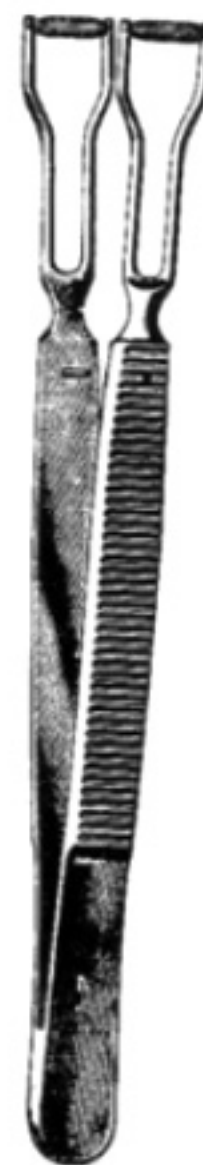

KNAPP
37-930 11cm

IRIS AND TENOTOMY SCISSORS



NOYES
37-940 12cm
37-942 12cm
37-944 12cm



1
37-940



2
37-942



3
37-944



WECKER
37-950 11cm
37-952 11cm
37-954 11cm



37-950



37-952



37-954



CASTROVIJO
37-960 10cm



OTOLOGY

POLYPUS SNARES



KRAUSE
39-210
(16cm)



KRAUSE-VOSS
39-220
(16cm)

EAR DRESSING FORCEPS

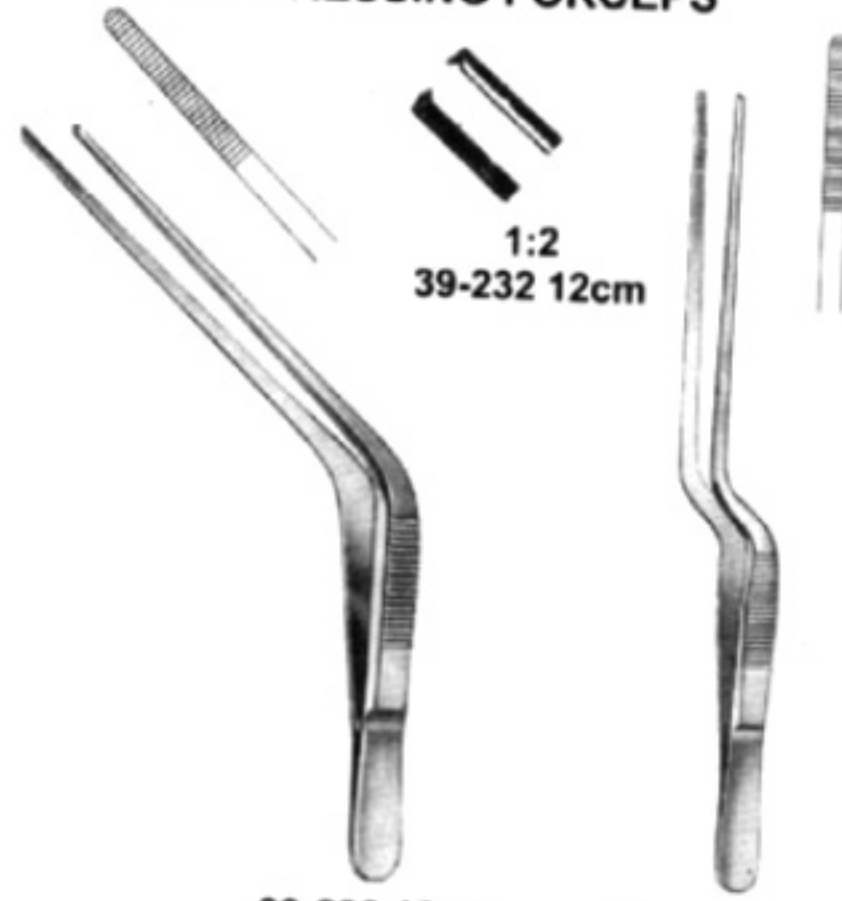

1:2
39-232 12cm

39-230 12cm

39-240 14cm

POLYPUS & FOREIGN BODY FORCEPS



QUIRE
39-250



80 HARTMANN
39-260 12cm

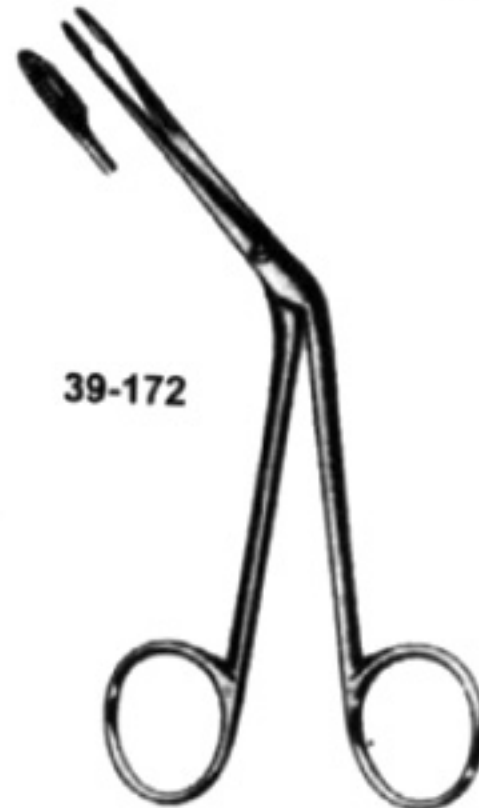

39-172

HARTMANN
39-270 14cm



YANKAUER
39-280 15cm



OTOLOGY EAR FORCEPS

39-290	8.5cm	39-295	8.5cm
39-291	14cm	39-296	8.5cm
39-292	16.5cm	39-297	8.5cm
39-293	8.5cm	39-298	8.5cm
39-294	14cm	39-299	8.5cm
		39-300	8.5cm



HARTMANN



39-290 8.5cm
39-291 14cm
39-292 16.5cm



39-293 8.5cm
39-294 14cm



39-295 8.5cm



39-296 8.5cm



39-297 8.5cm

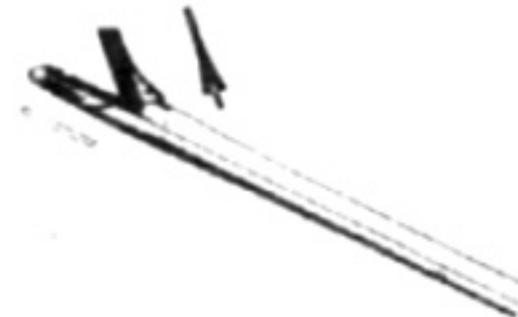

39-298 8.5cm



39-299 8.5cm



39-300 8.5cm



RHINOLOGY NAZAL SPECULA

NAZAL SPECULA



VIENNA
41-100 ADULT
41-102 CHILD
41-104 INFANT



KILLIAN
41-110 Fig 1
41-112 Fig 2
41-414 Fig 3
41-416 Fig 4

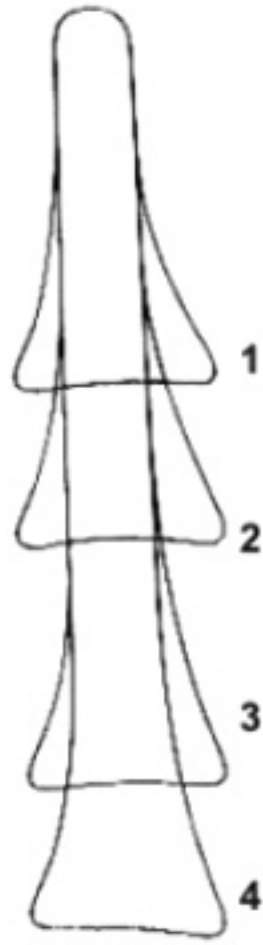

THUDICHUM
41-120 Fig 0
41-122 Fig 1
41-124 Fig 2
41-126 Fig 3
41-128 Fig 4

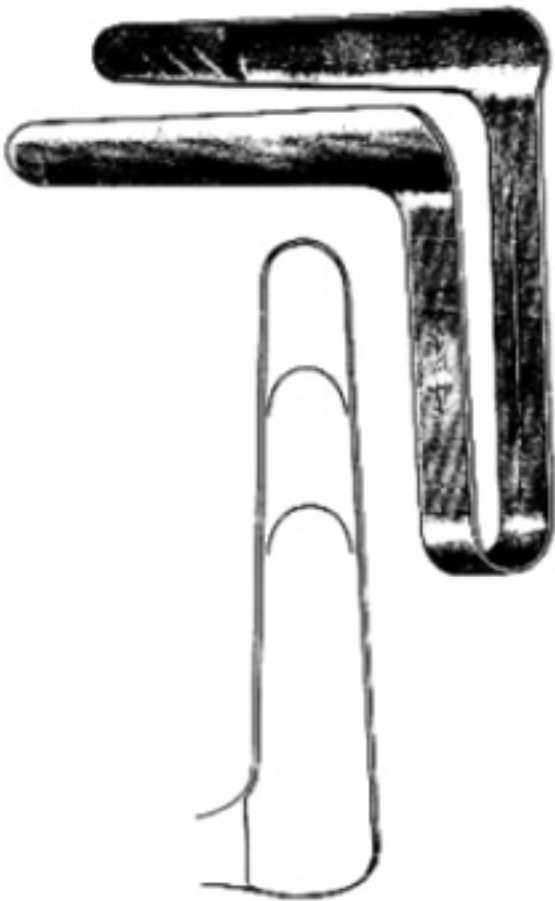

ST-CLAIR THOMSON
41-130 Fig 1
41-132 Fig 2
41-134 Fig 3

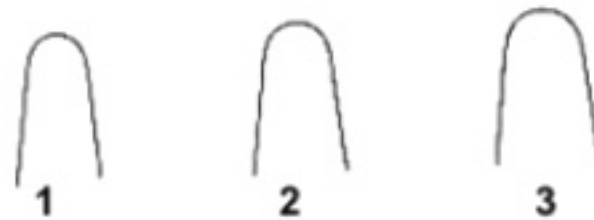

VOLTOLIN
41-140 Fig 1
41-142 Fig 2
41-144 Fig 3



YANKAUER
41-150 19cm



RHINOLOGY

NAZAL SNARE



KRAUSE
41-160



KRAUSE-VOSS
41-170

NAZAL DRESSING FORCEPS



TROELTSCH
41-180 18cm



JANSEN
41-190 20cm

NAZAL CUTTING FORCEPS

NAZAL DRESSING FORCEPS



KEYMANN-KNIGHT
41-200 18cm

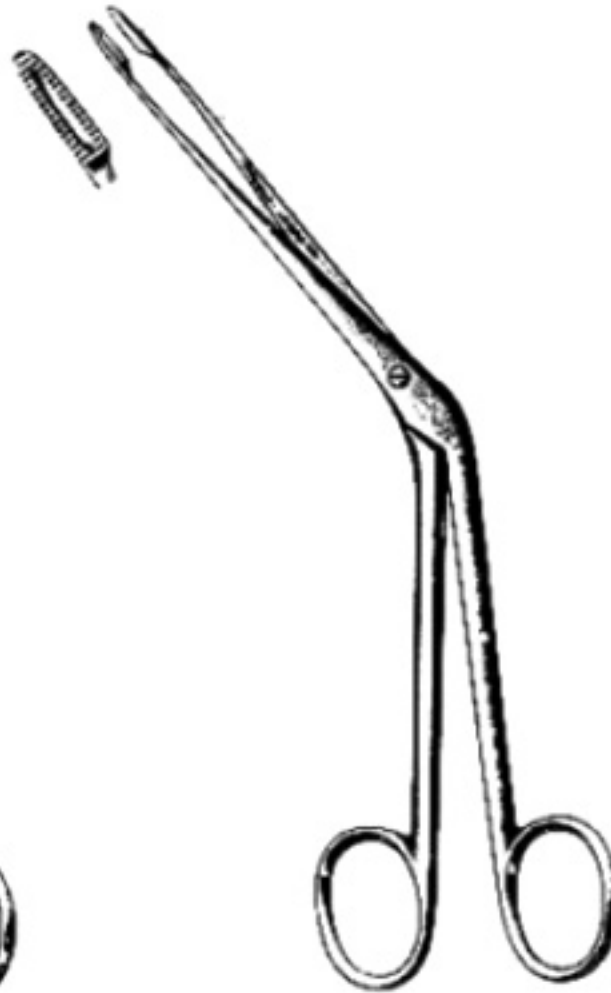

HARTMAN
41-210 20cm

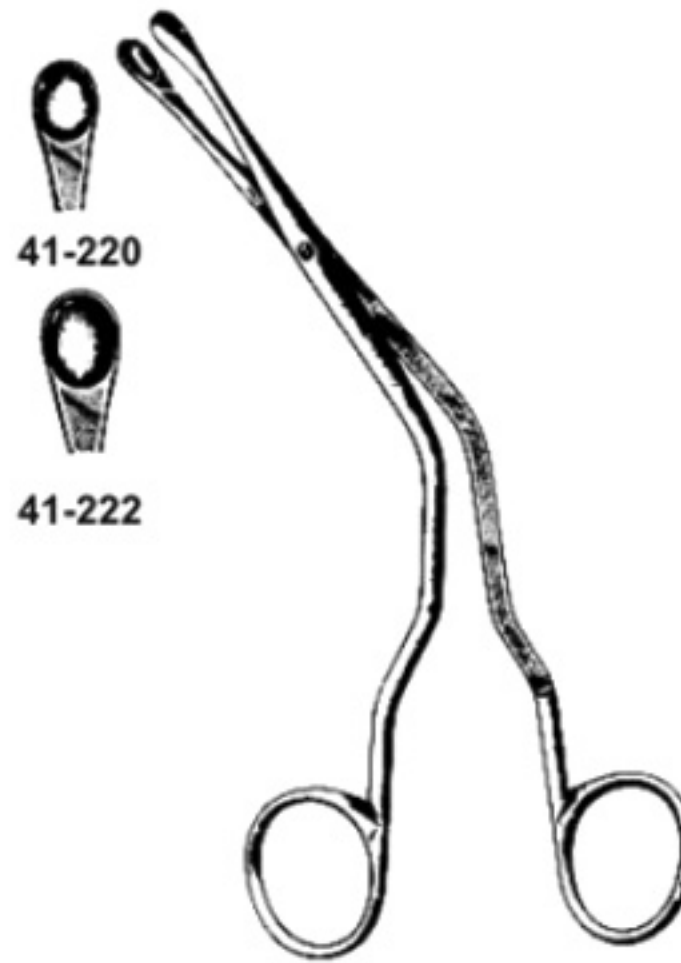

41-220

41-222

LUC
41-220 20cm
41-222 20cm



RHINOLOGY

NAZAL CUTTING FORCEPS

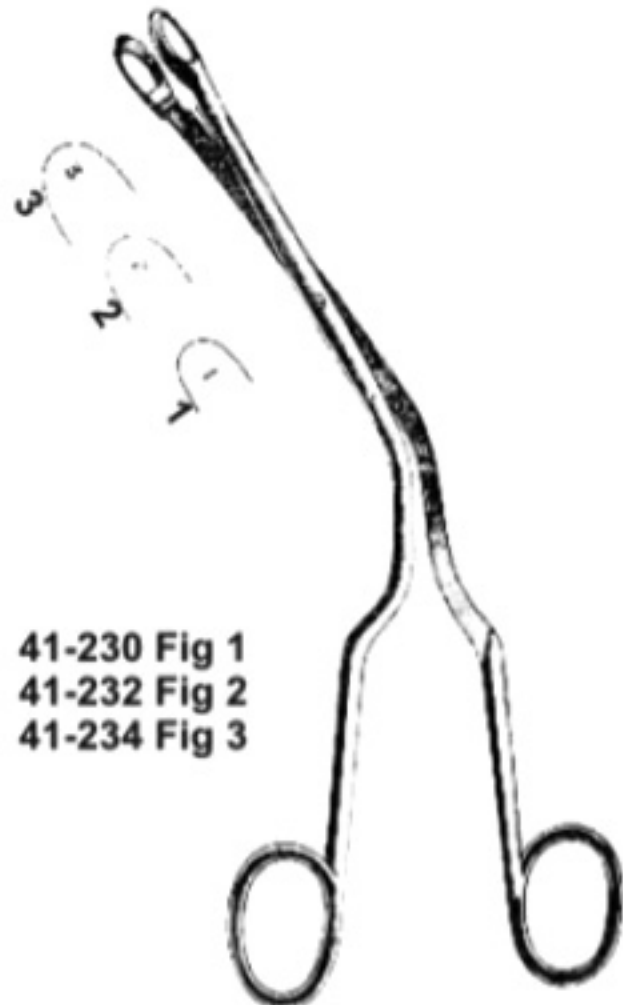

41-230 Fig 1
41-232 Fig 2
41-234 Fig 3

LUC
20cm



BRUENING
41-240 20cm
41-242 20cm
41-244 20cm
41-246 20cm



STRUYCKEN
41-250



STRUYCKEN
41-251



HAJEK
41-252



MYLES
41-253



HARTMANN
41-254



WEIL
41-255



TAKAHASHI
41-256



TAKAHASHI
41-257

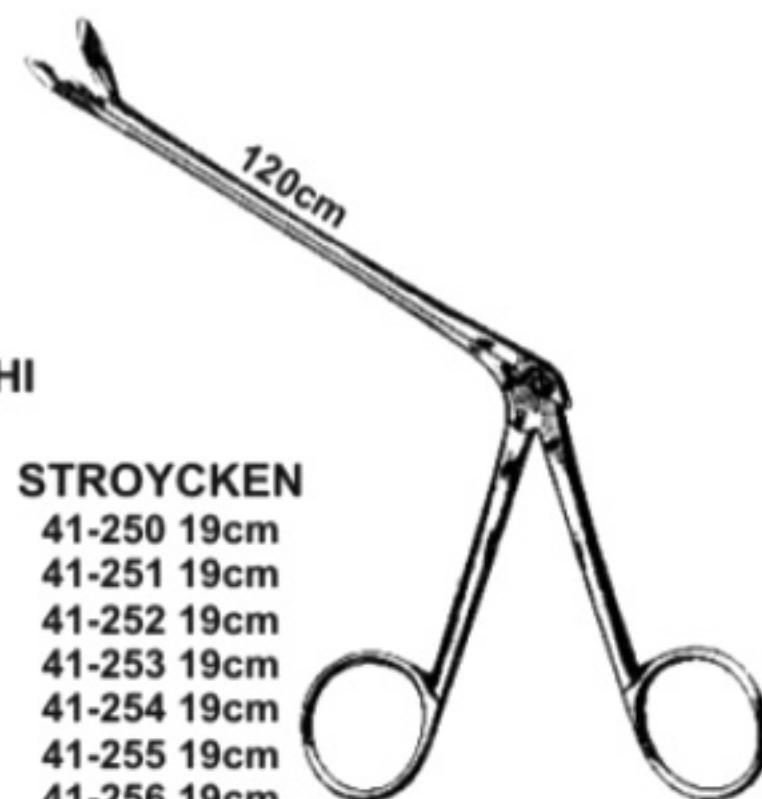

STROYCKEN
41-250 19cm
41-251 19cm
41-252 19cm
41-253 19cm
41-254 19cm
41-255 19cm
41-256 19cm
41-257 19cm



RHINOLOGY NAZAL CUTTING FORCEPS

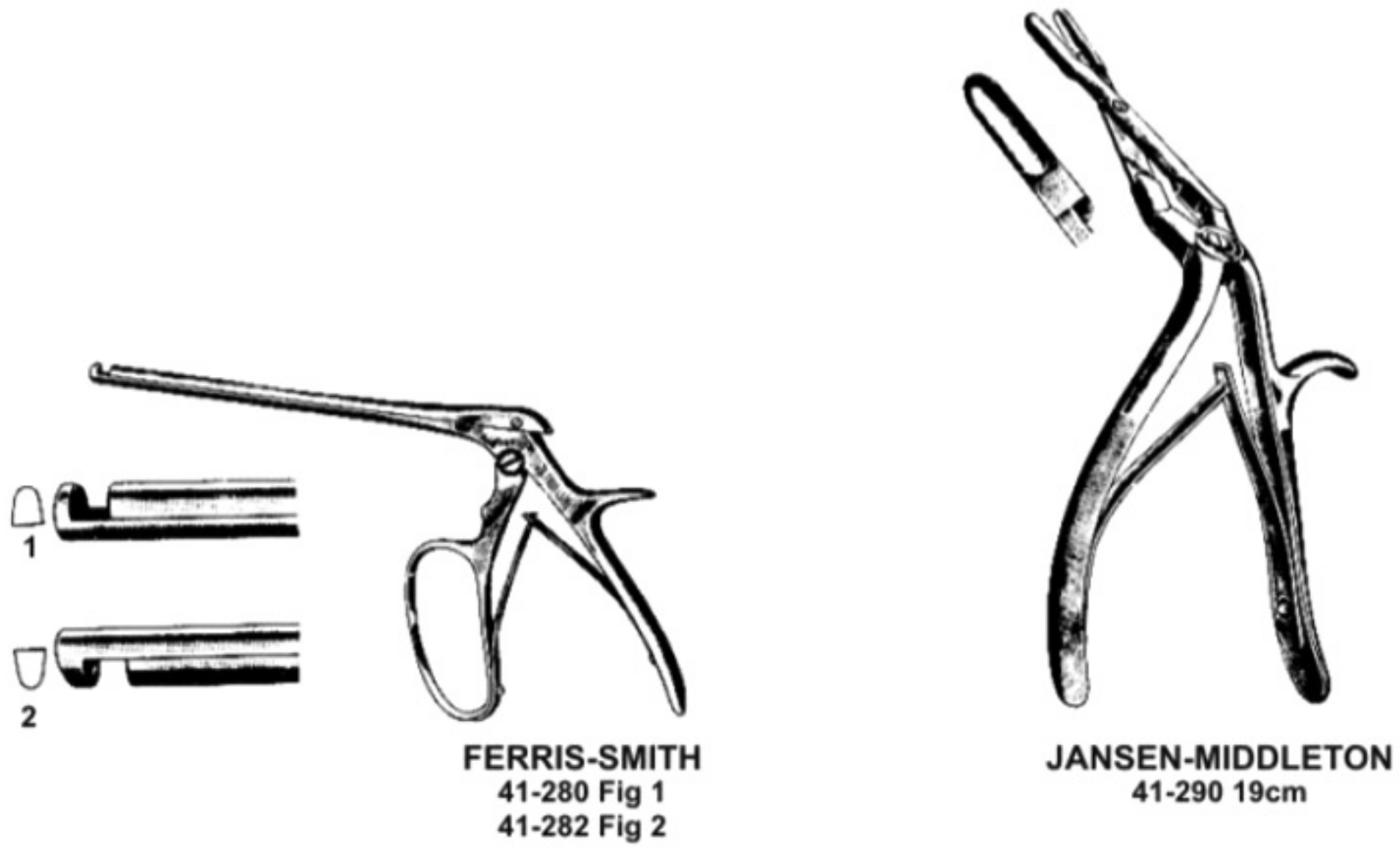
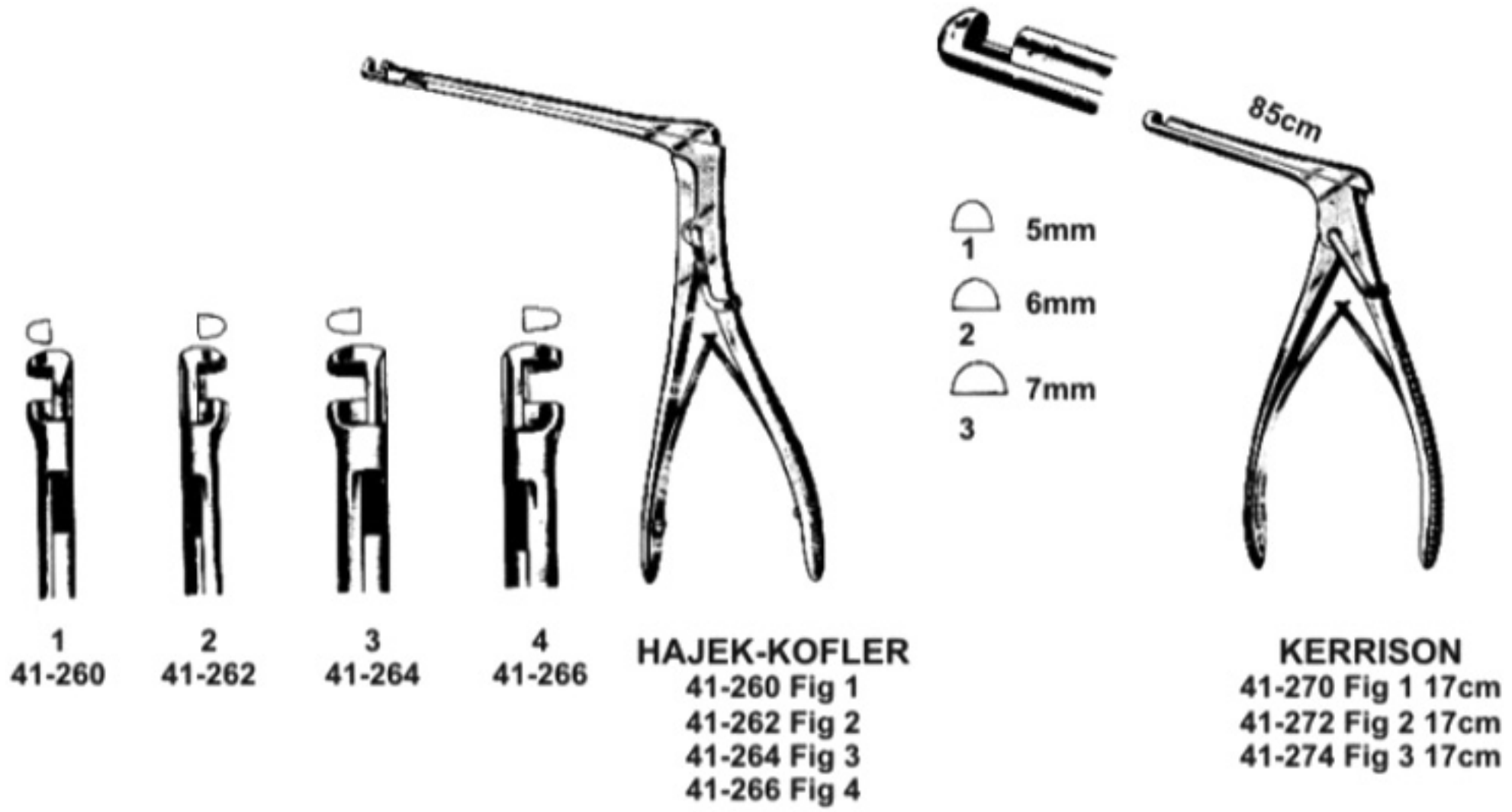



RHINOLOGY

SEPTUM FORCEPS



ASCH
41-300 23cm

WALSHAM
41-310 23cm

WALSHAM
41-320 23cm

KNIVES



BALLENGER
41-330

BRUENINGS
41-340

FREER
41-350

CURETTES



MYLES
41-360 17cm
41-362 17cm
41-364 17cm
41-366 17cm
41-368 17cm

KNIVES

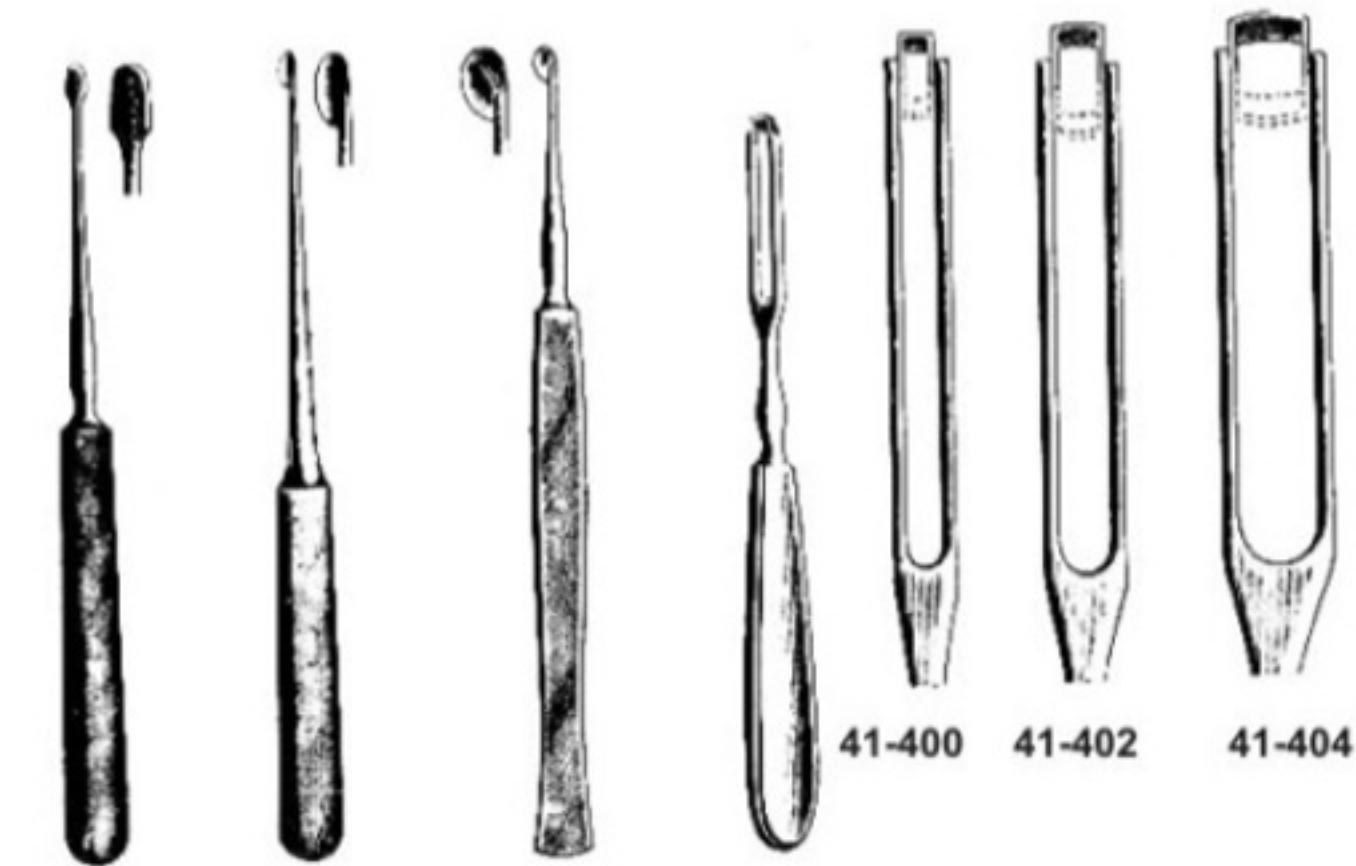

FREER
41-370

FREER
41-380

FREER
41-390

BALLENGER
19cm
41-400 3mm
41-402 4mm
41-404 5mm



RHINOLOGY

ELEVATORS



FREER
41-410

FREER
41-420

FREER 16.5cm

GOUGES



6mm



BALLENGER 16cm
41-440 4mm
41-442 6mm
41-444 9mm



KILLIAN
41-450 5mm

CHISELS



4mm

FREER
41-460



4mm

FREER
41-470

SINUS CANNULA

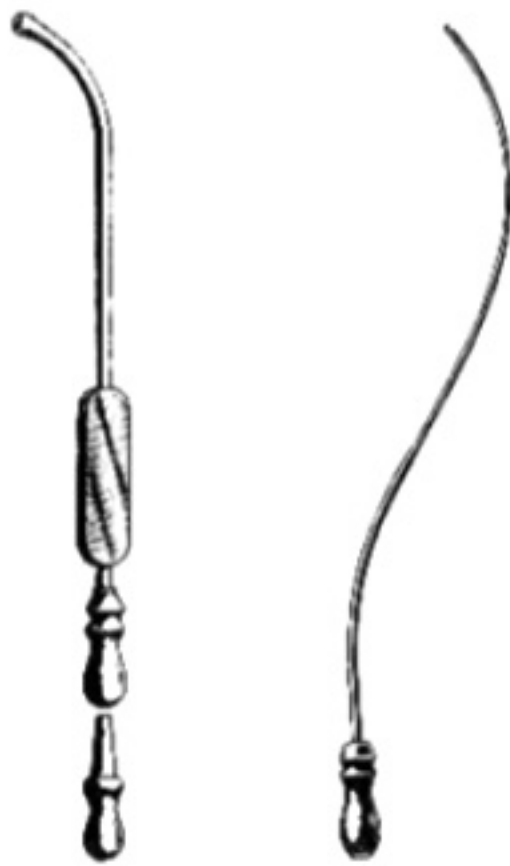

EICKEN-KILLIAN 41-480 3mmØ
KILLIAN 41-490 1.5cmØ

ANTRUM CANNULA

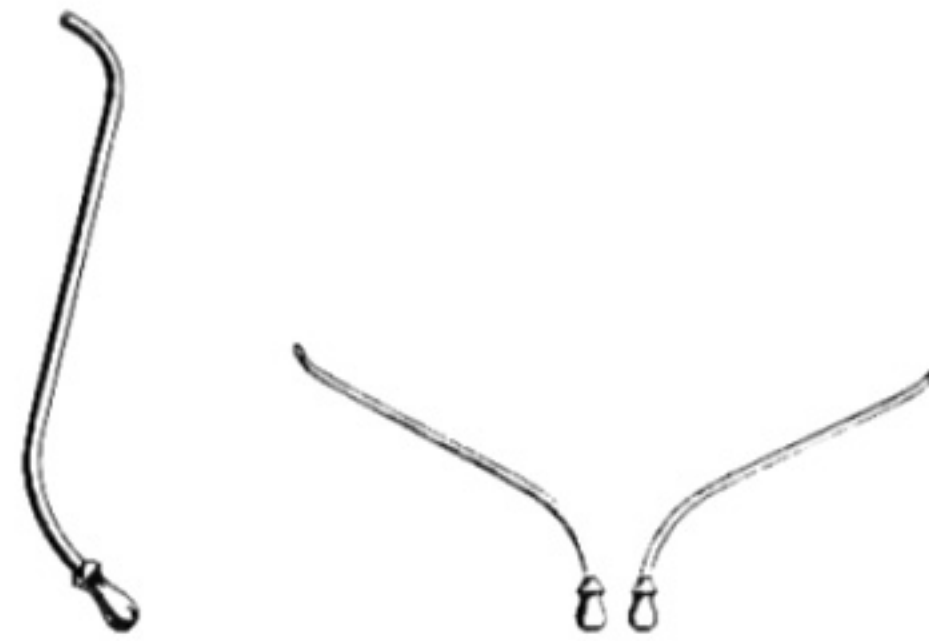

HARTMANN
41-500

HARTMANN
41-510 2 mmØ
41-512 2.5mmØ
41-514 3 mmØ



RHINOLOGY

ADENOID CURETTE

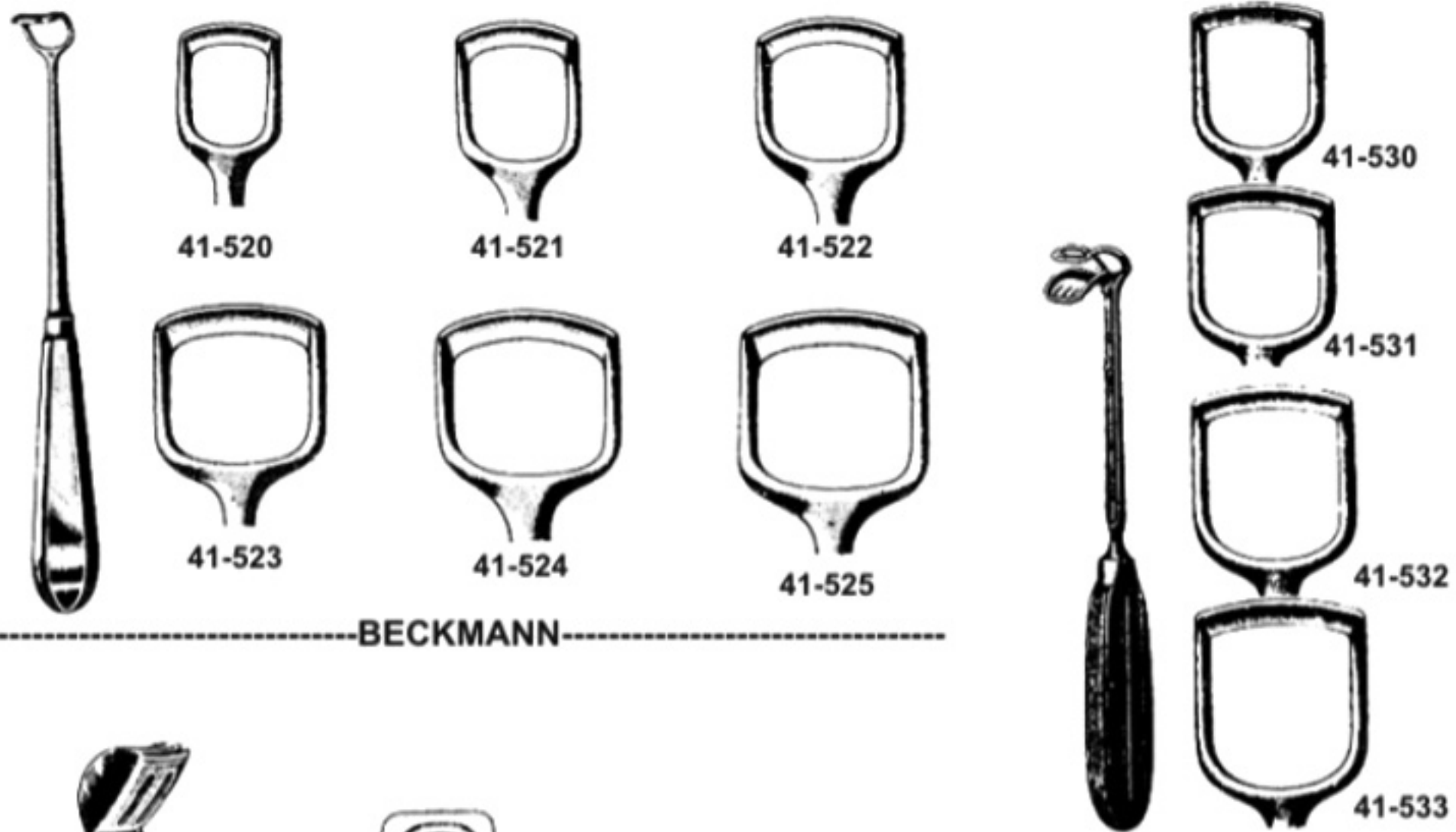

-----BECKMANN-----

ST. CLAIR THOMSON

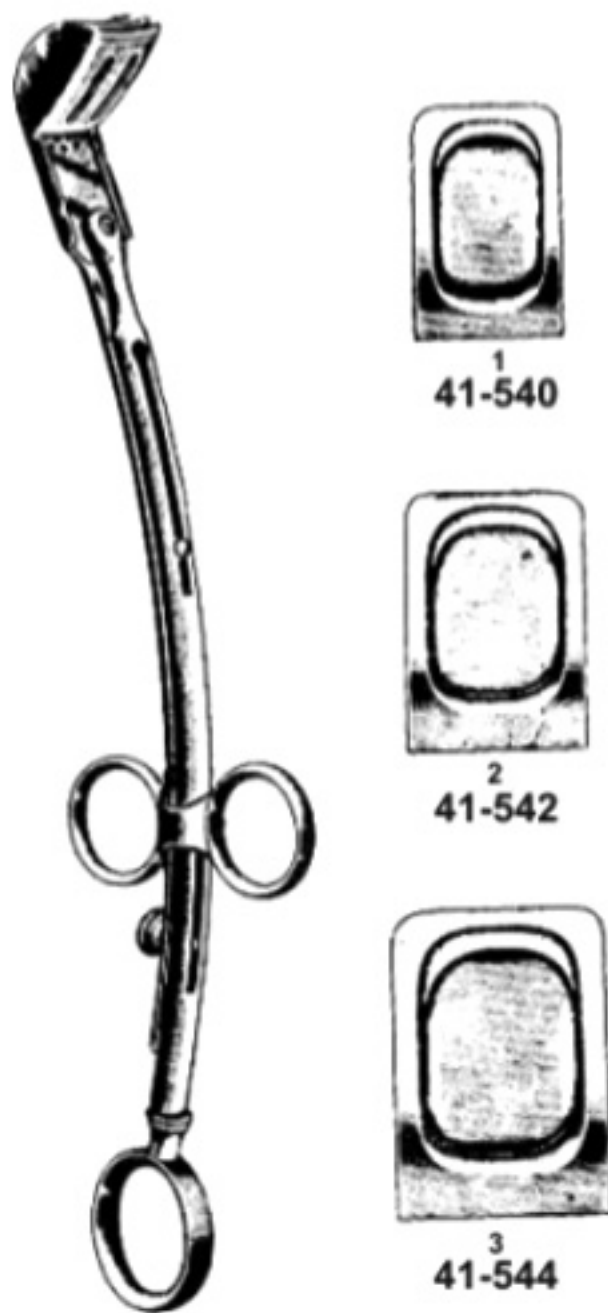

LA-FORCE

SAW

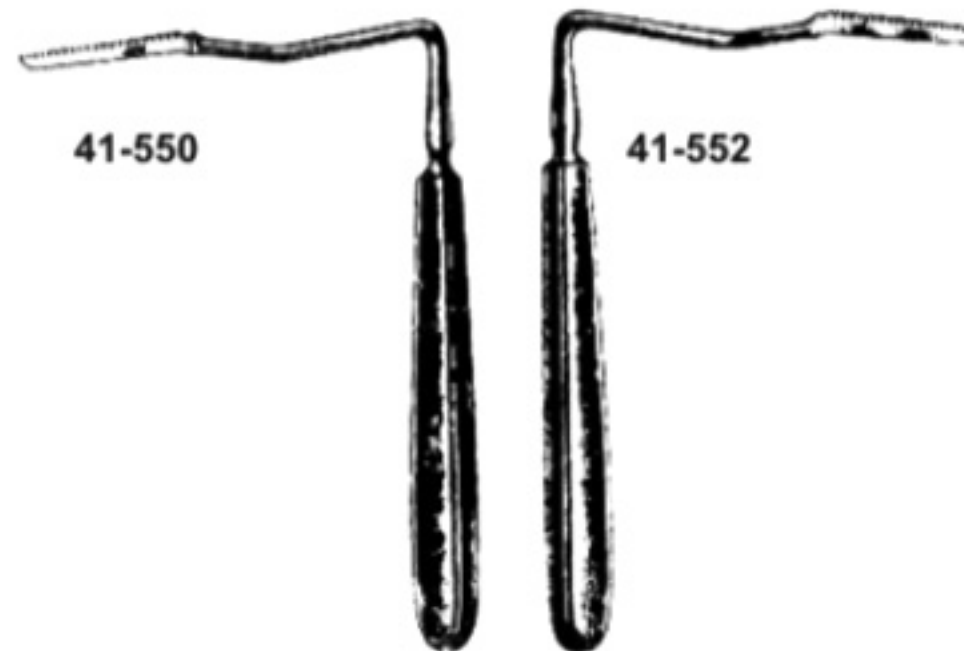

JOSEPH



ORAL INSTRUMENTS

MOUTH GAGS



DOYEN
43-100 CHILD
43-102 ADULT



MOLT
43-110 14cm



FURGUSSON
43-120 15cm) P.JAWS
43-122 19cm)
43-124 15cm) A.JAWS
43-126 19cm)



MASON
43-130 15cm) P.JAWS
43-132 19cm)
43-134 15cm) A.JAWS
43-136 19cm)



ROSER-KONIG
43-140 16cm
43-142 19cm



DENHART
43-150 12CM



BUXTON
43-160 A.JAWS
43-162 P.JAWS



HEISTER
43-170 13cm



ORAL INSTRUMENTS

MOUTH GAGS



HEISTER
43-180 12cm

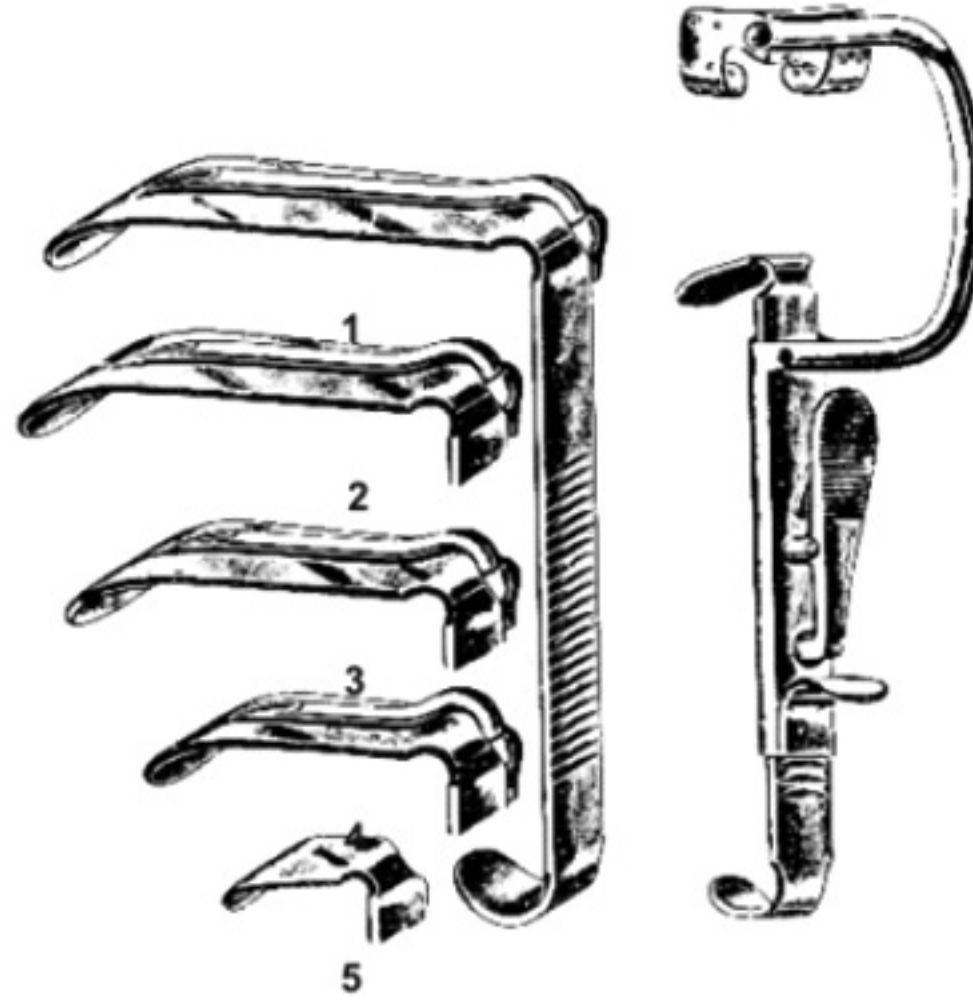

DAVIS-BOYLE
43-190 SET



JENNING
43-200 9cm
43-202 11cm
43-204 13cm
43-206 15cm



WHITEHEAD
43-210 11cm
43-212 13cm
43-214 15cm



WHITEHEAD
43-220 11cm
43-222 13cm
43-224 15cm



ORAL INSTRUMENTS TONGUE DEPRESSORS

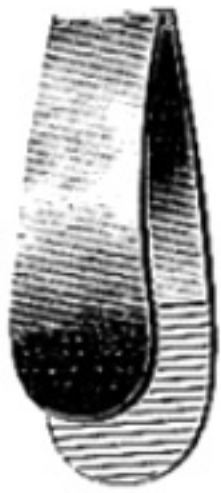

TOBOLD
43-228 12.cm



43-230 14.5cm



BRUENING
43-240 19cm



MAYO
43-250 17cm
43-252 19cm



BUCHWALD
43-260 18cm

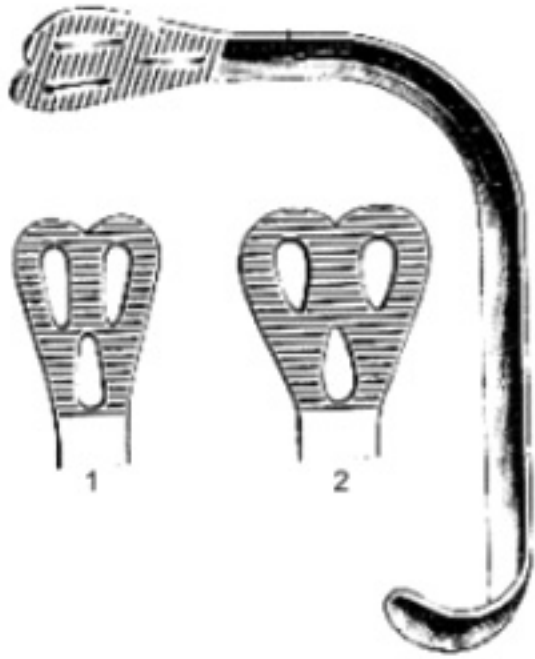

WIEDER
43-270 Fig 1 14cm
43-272 Fig 2 15cm



LACK
43-280 CHILD
43-282 ADULT

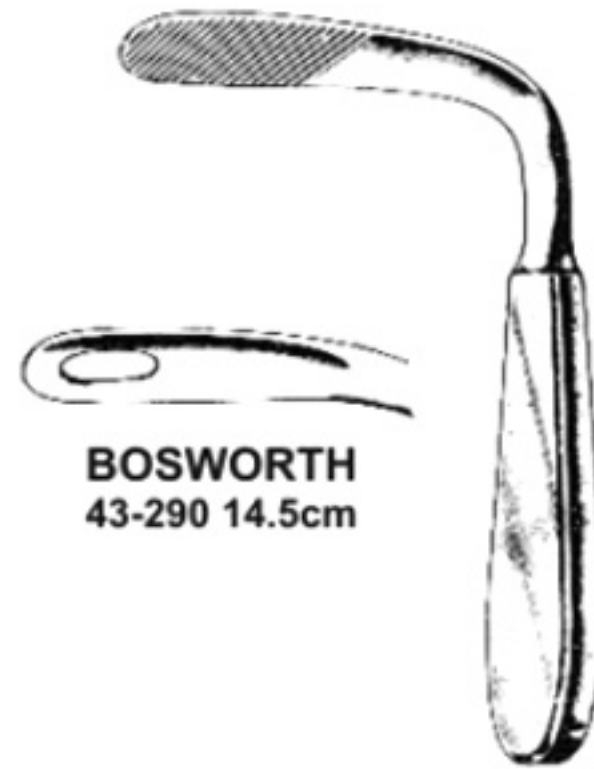

BOSWORTH
43-290 14.5cm

TOBLOD
43-300 14.5cm



ORAL INSTRUMENTS TONGUE DEPRESSORS



CARMALT
41-310 12.5cm



CARBOULD
43-320 14cm

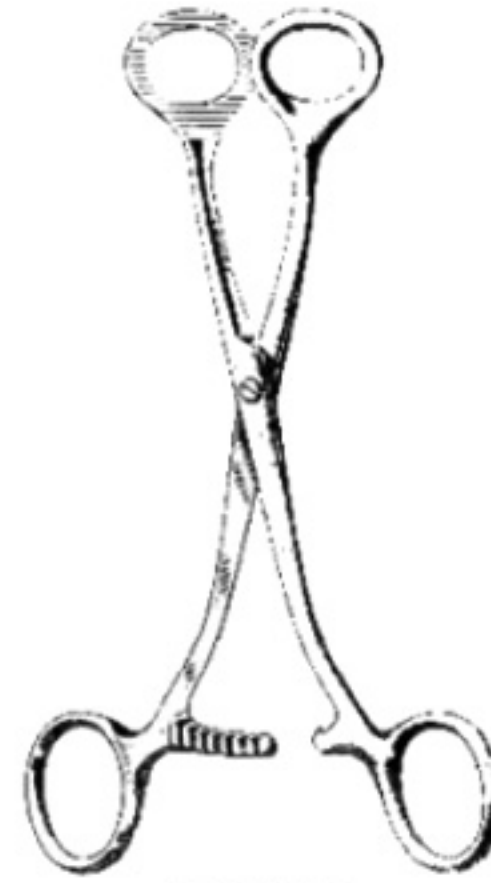

COLLIN
43-330 16cm
43-332 17cm
43-334 19cm



GUY
43-340 16cm



MATHIEU
43-350 19cm



43-360 17cm



YOUNG
43-370 16cm



TONSIL

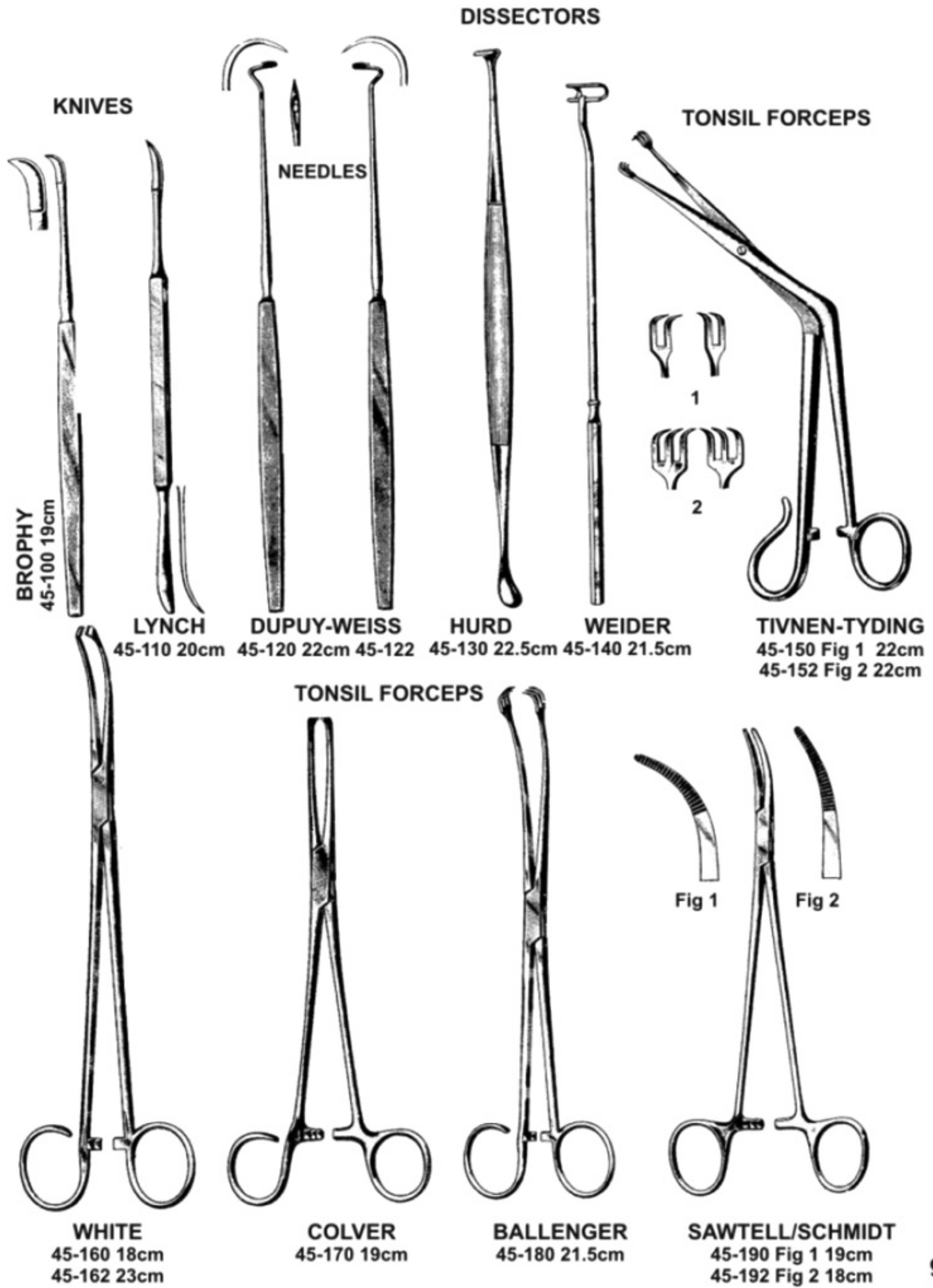



TONSIL

SNARES

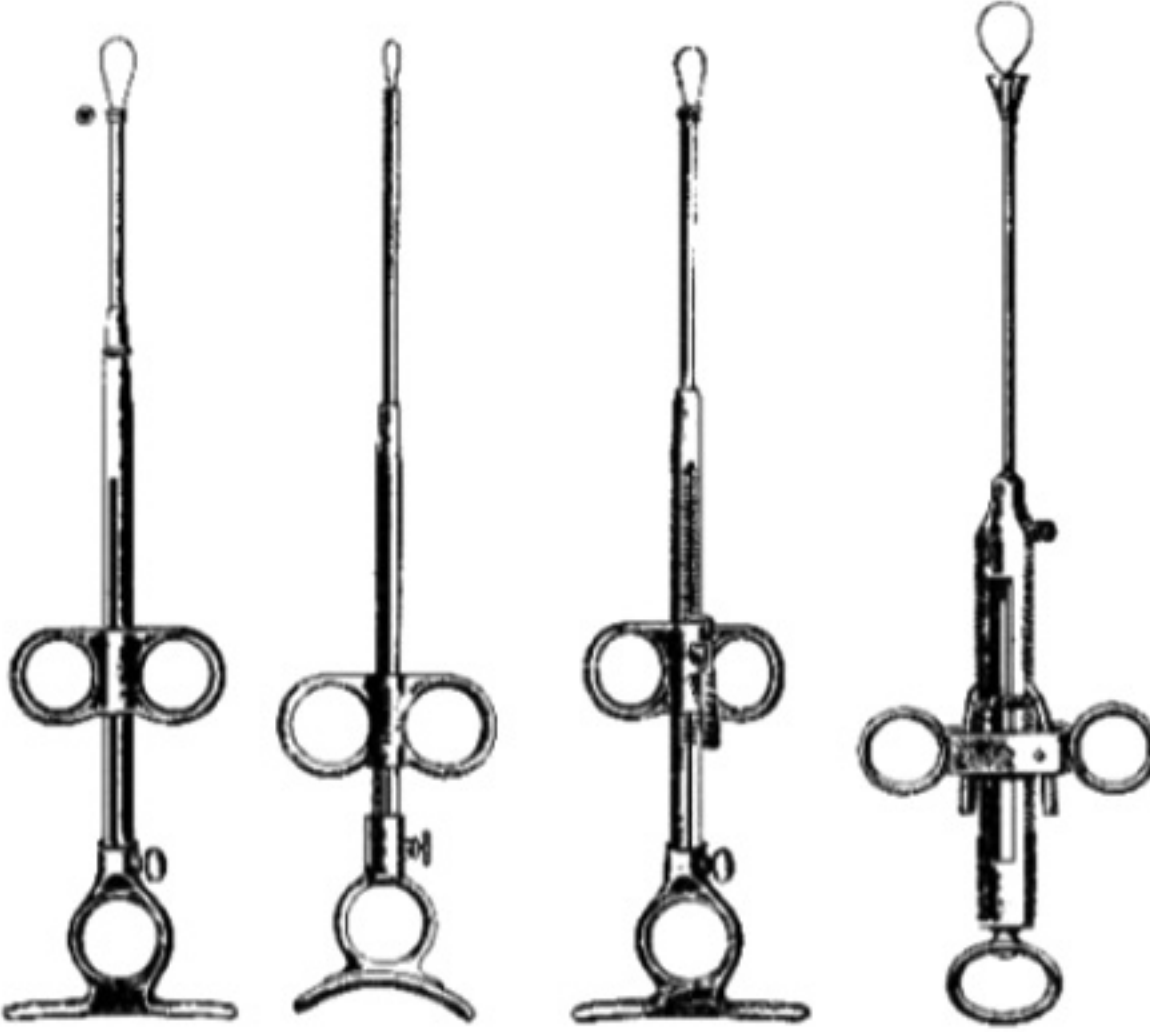

EVES
45-200 28cm

EVES
45-210 28cm

EVES
45-220 28cm

BRUENING
45-230 28cm

PUNCH FORCEPS



HARTMANN
45-240 13mm
45-242 15mm
45-244 17mm

GUILLOTINES

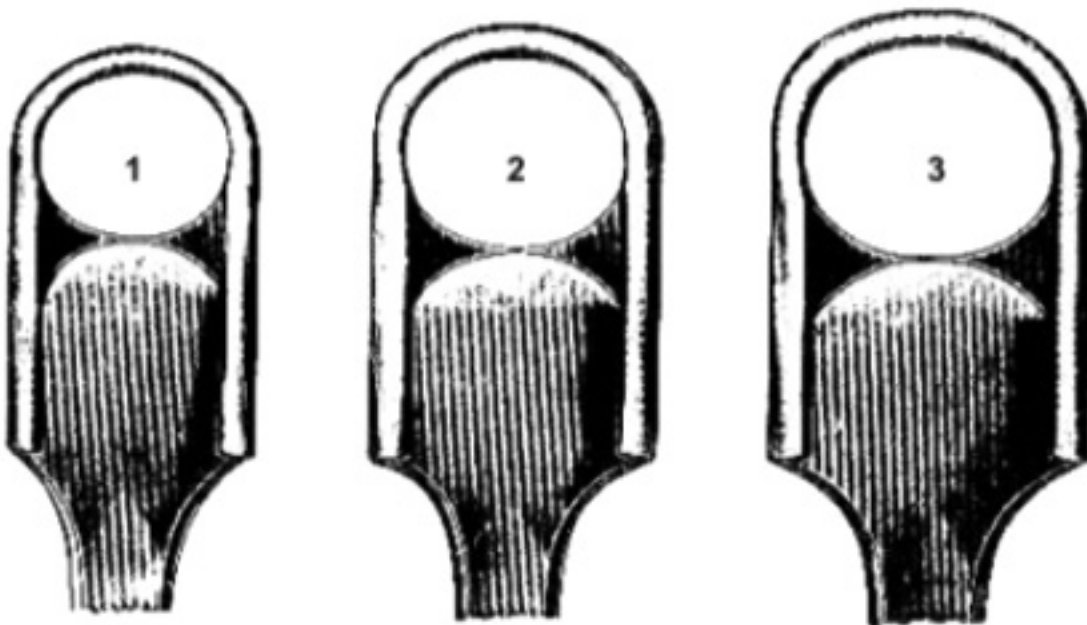

94

SLUDER-BLEENGER
45-250 SET
45-252 Fig 1
45-254 Fig 2
45-256 Fig 3



ESOPHAGOSCOPY LARYNGEAL FORCEPS

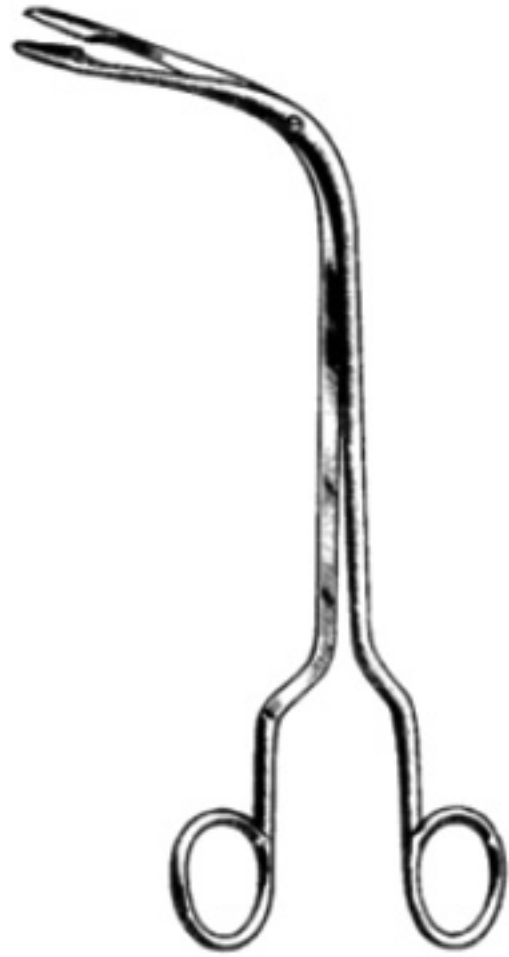

FRAENKEL
47-100 18cm

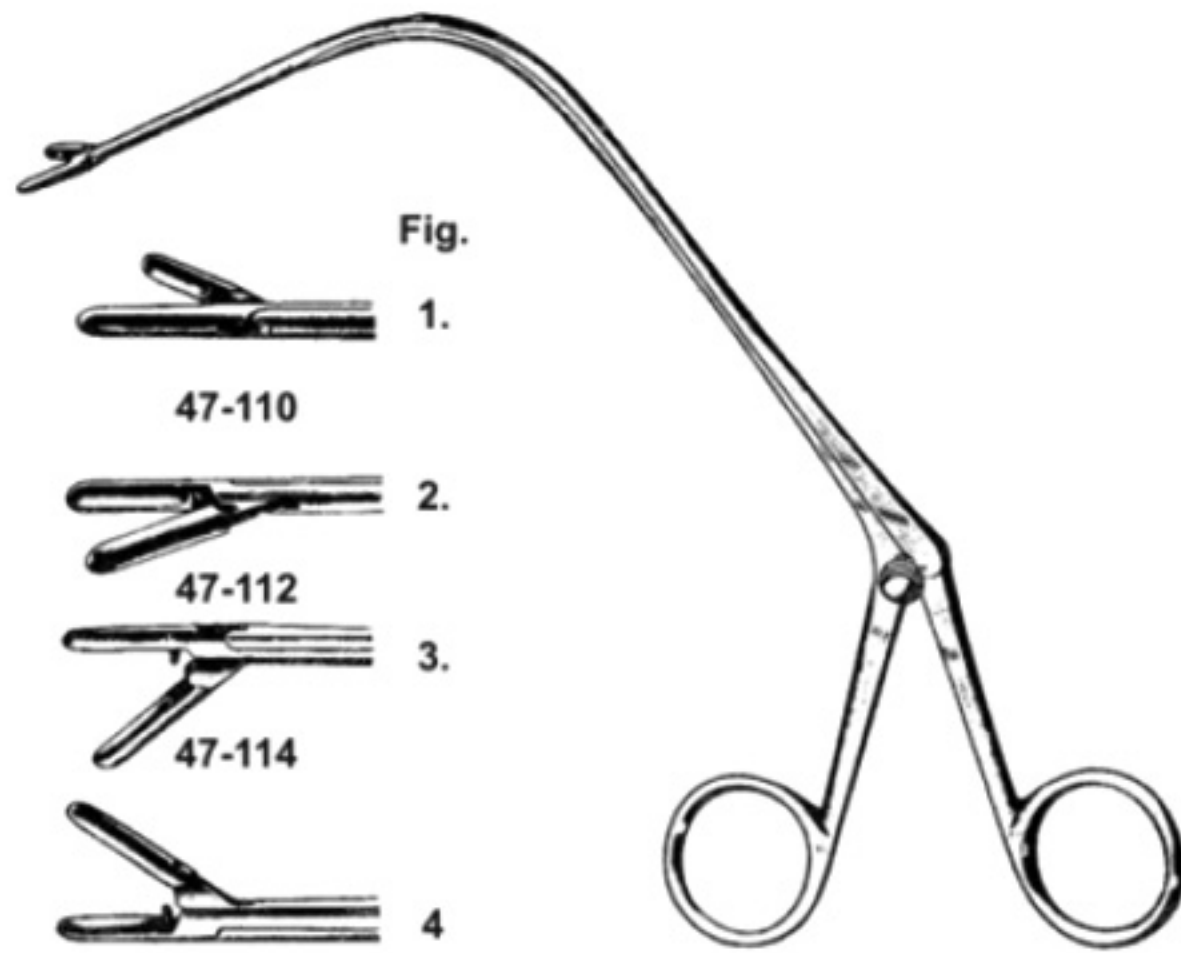

JURASZ
47-110 19cm
47-112 19cm
47-114 19cm
47-116 19cm



CHEVALIER-JACKSON

	40cm	50cm	60cm
Fig 1	47-120	47-130	47-140
Fig 2	47-121	47-131	47-141
Fig 3	47-122	47-132	47-142
Fig 4	47-123	47-133	47-143
Fig 5	47-124	47-134	47-144
Fig 6	47-125	47-135	47-145
Fig 7	47-126	47-136	47-146

HANDLES

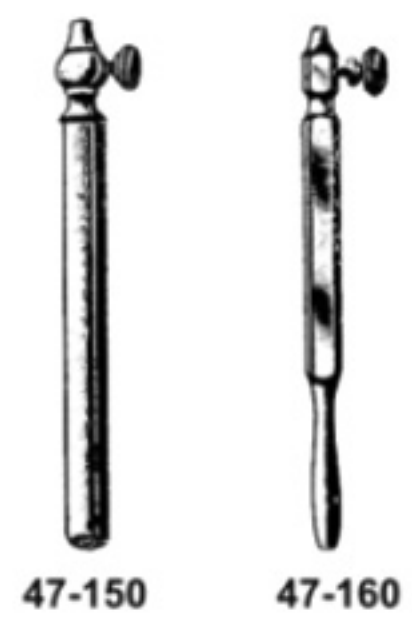



TRACHEOTOMY

TRACHAEL HOOKS

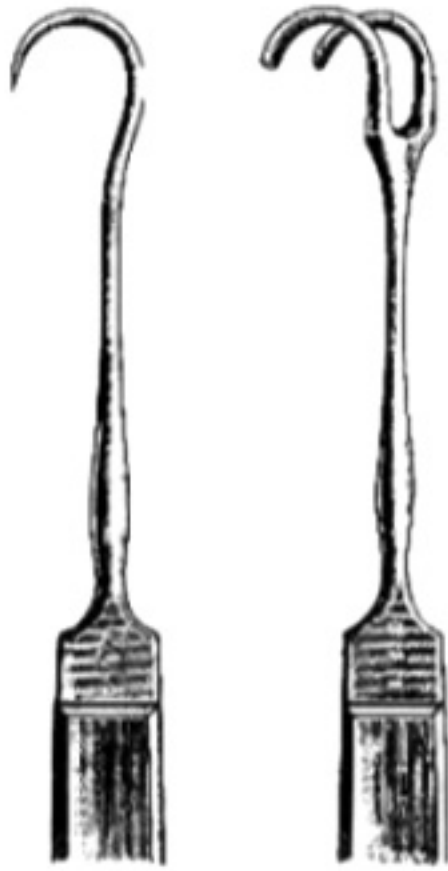

49-100

49-110

DILATING FORCEPS



TROUSSEAU
49-120 10.5cm
49-122 14 cm

LABORDE
49-130 14cm

TRACHEAL TUBES



JACKSON
49-140
4 To 32mm



FULLER
49-150
18 To 32 F.G



CUBLEY
49-160
18 To 32 F.G



INTESTINES AND STOMACH

GOITRE FORCEPS



LAHEY
51-100 15cm
51-102 20cm



MASTIN
51-110 17cm



SCHOEMAKER
51-120 15cm

ENACULATORS



KOCHER
51-130 16cm



KOCHER
51-140 15cm

EXTRACTORS



UNNA 51-150 14cm
UNNA 51-160 14cm

HOOKS



KILNER 51-170 15cm
GILLIES 18cm
51-180 Fig 1
51-182 Fig 2

TISSUE FORCEPS

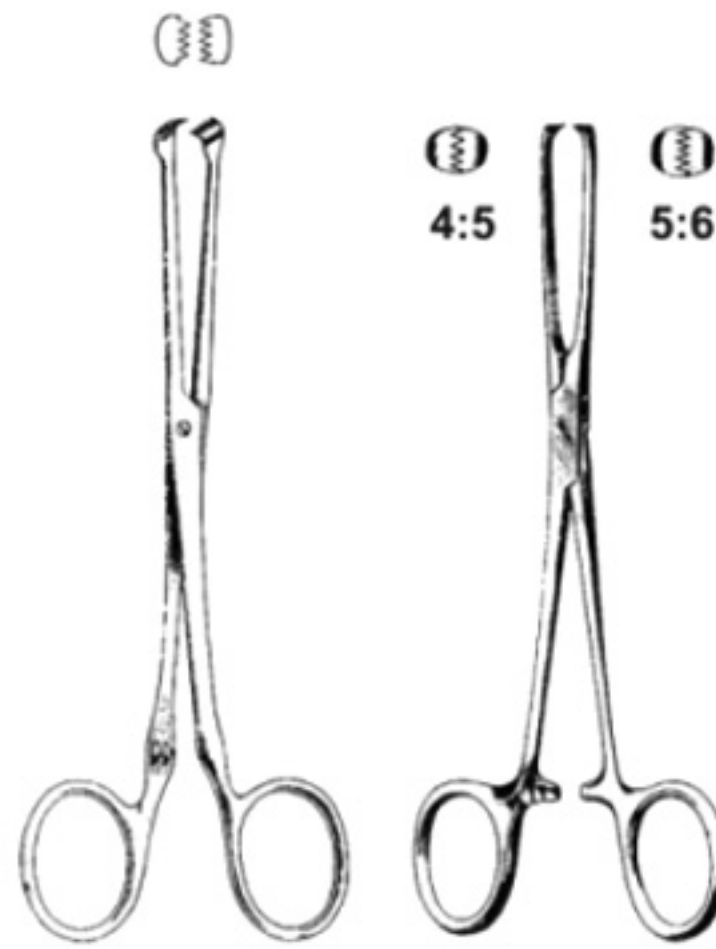

4:5
ALLIS 51-190 15cm
4:5
ALLIS 51-200 4:5 15cm
5:6
ALLIS 51-202 5:6 15cm



INTESTINES AND STOMACH INTESTINAL FORCEPS



ALLIS
51-210 20cm



LOCKWOOD
51-220 20cm



ALLIS-ADAIR
51-230 15.5cm



LOCKWOOD-ALLIS
51-240 16cm
51-242 20cm



JUDD-ALLIS
51-250 15cm
51-252 19cm



LITTLEWOOD
51-260 19cm



STILLE
51-270 20cm

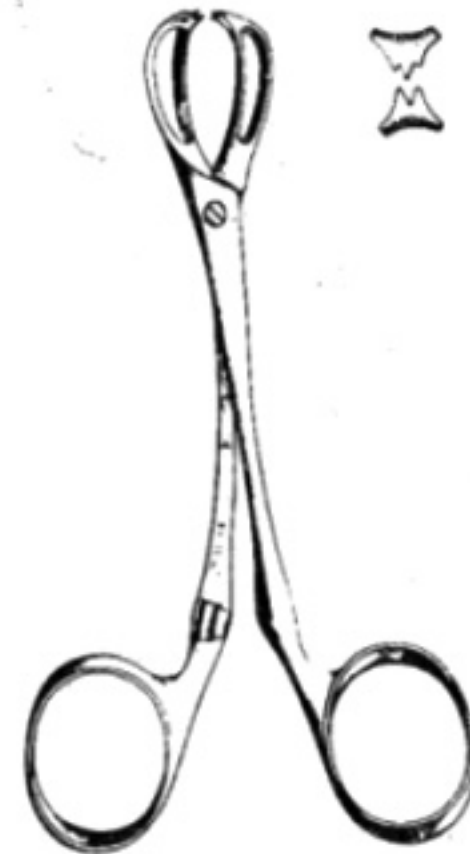

LANE
51-280 12.5cm
51-282 15 cm
51-284 19 cm



INTESTINES AND STOMACH INTESTINAL FORCEPS



LANE
51-290 12.5cm
51-292 15 cm
51-294 19 cm



BOBCK
51-300 16cm
51-302 18cm
51-304 20cm
51-306 24cm



PORRIER
51-310 12.5cm
51-312 18 cm



PERCY
51-320 24cm



DENNIS-BROWN
51-330 18cm

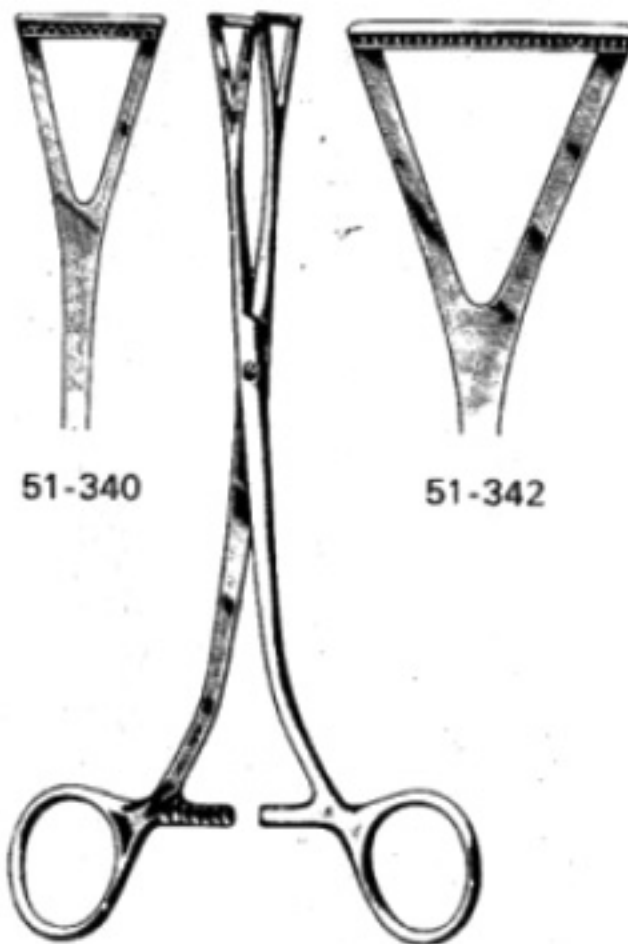

DUVAL-COLLIN
51-340 18cm
51-342 20cm

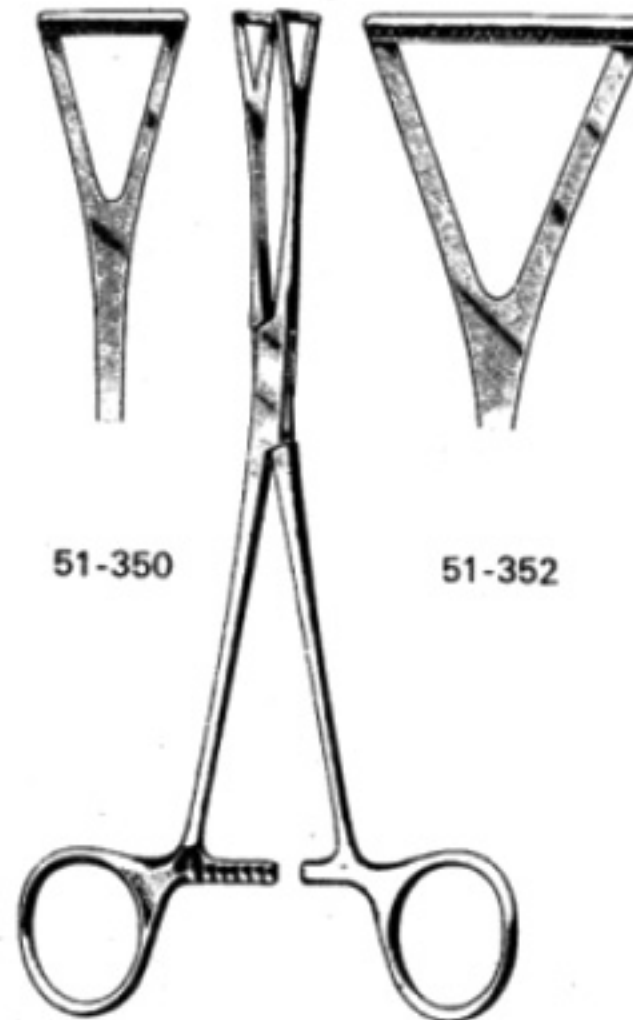

COLLIN
51-350 20cm
51-352 23cm



INTESTINES AND STOMACH

INTESTINAL FORCEPS

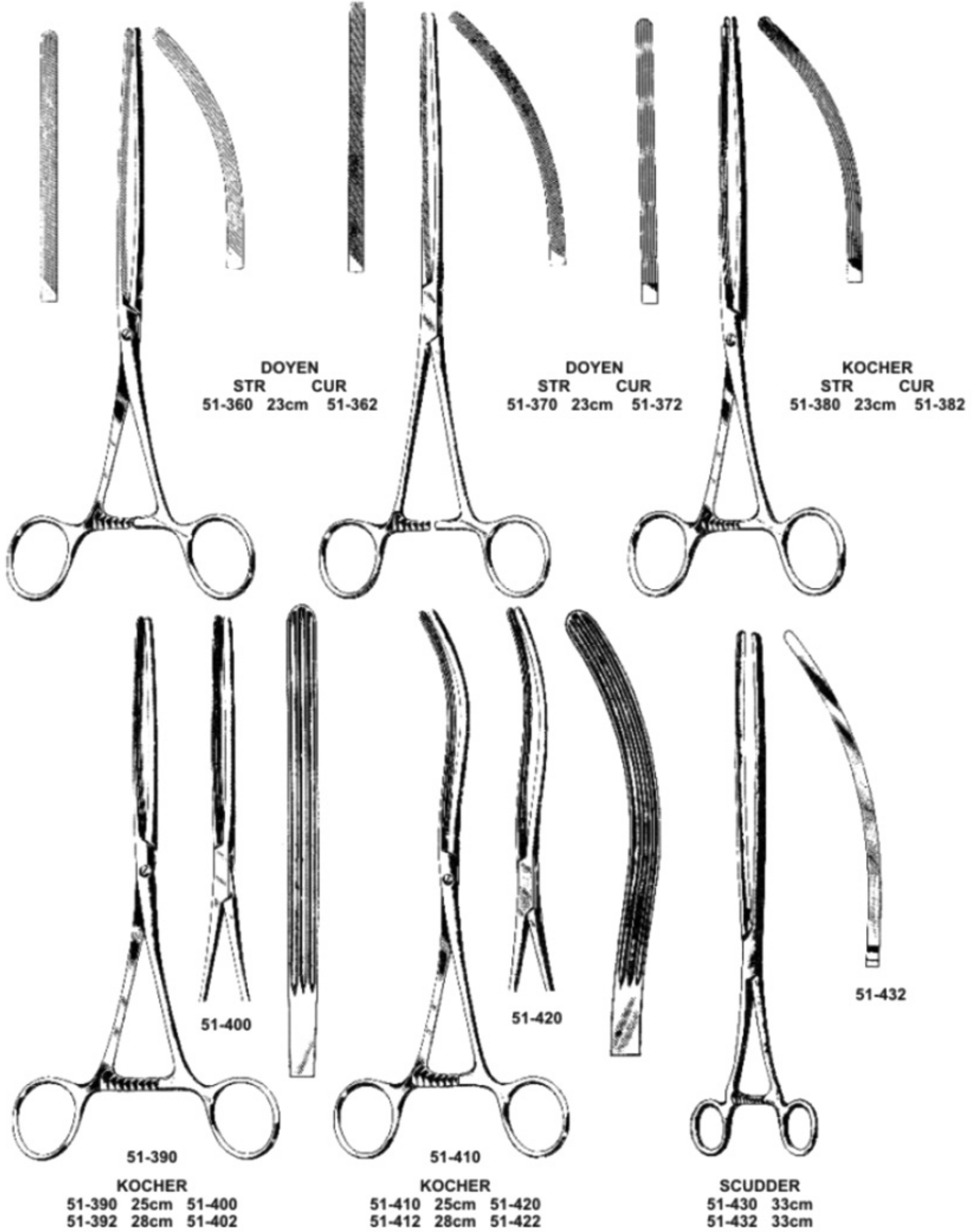



INTESTINES AND STOMACH

INTESTINAL FORCEPS

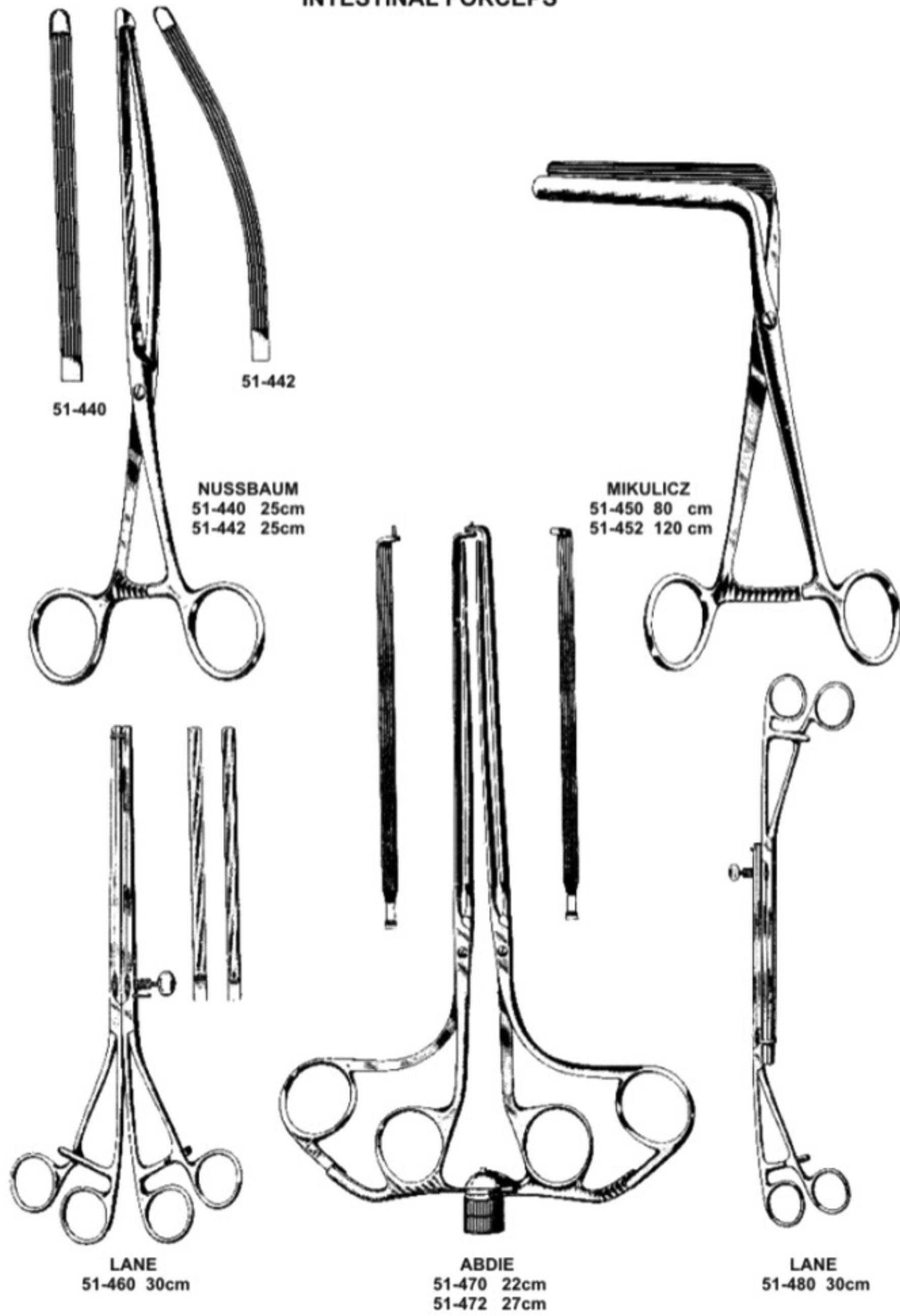



INTESTINES AND STOMACH

INTESTINAL AND STOMACH CLAMPS



LANE
51-490 30cm



PAYR
51-500 15cm



PAYR
51-510 21cm



PAYR
51-520 29cm
51-522 35cm



RANKIN
51-530 22cm



RECTUM RECTAL SPECULA



SIMS
53-100 15cm



SIMS
53-110 15cm



SIMS
53-115 15cm



MATHIEU
53-120 19cm

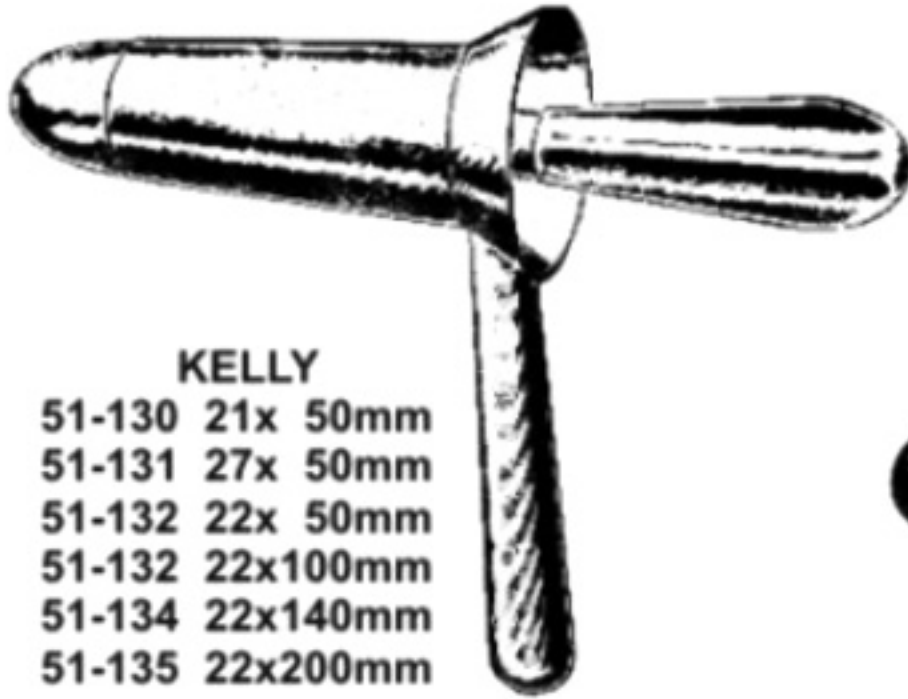

KELLY
51-130 21x 50mm
51-131 27x 50mm
51-132 22x 50mm
51-132 22x100mm
51-134 22x140mm
51-135 22x200mm



NAUTON-MORGAN
51-150 70x22mm



GABRIEL
51-140 64x24mm
51-142 49x19mm



RECTUM BIOPSY FORCEPS

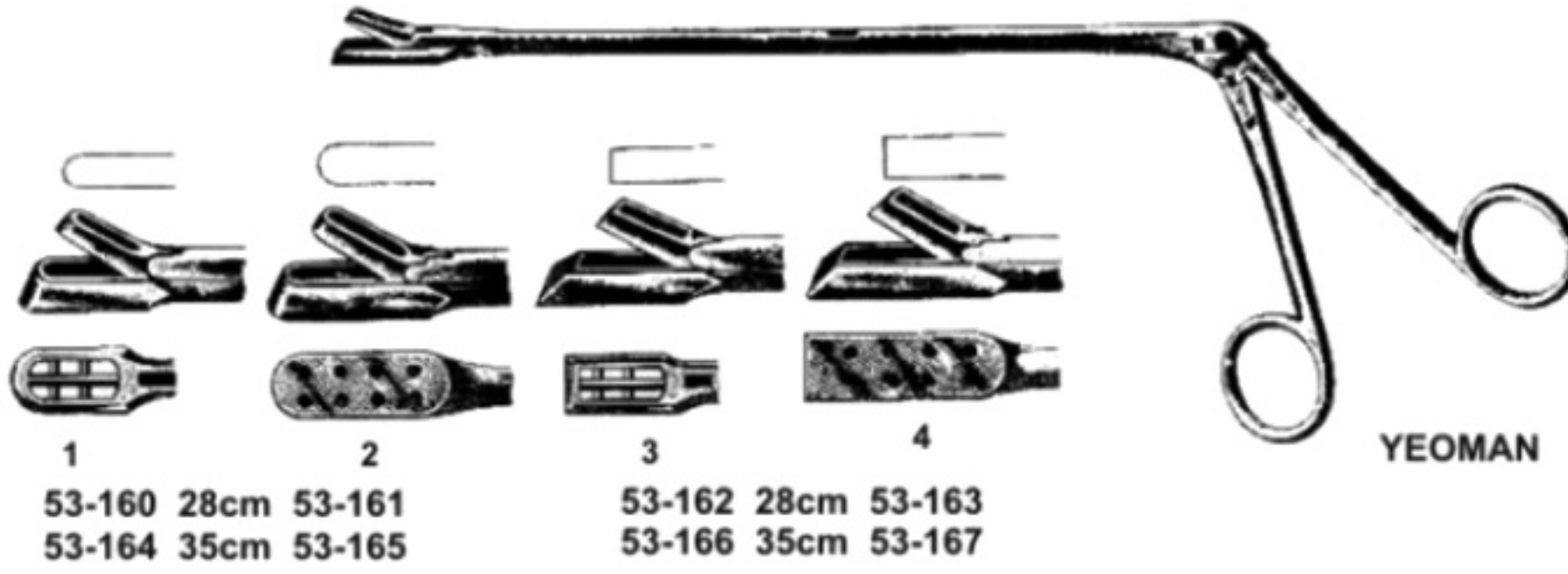

1
53-160 28cm
53-164 35cm

2
53-161
53-165

3
53-162 28cm
53-166 35cm

4
53-163
53-167

YEOMAN

COTTON CARRIER



PILE FORCEPS



LURE
53-170 24.5cm



JARVIS
53-180 23cm



LANGENBECK
53-190 26cm



53-200 45cm



GALL BLADDER

DILATORS

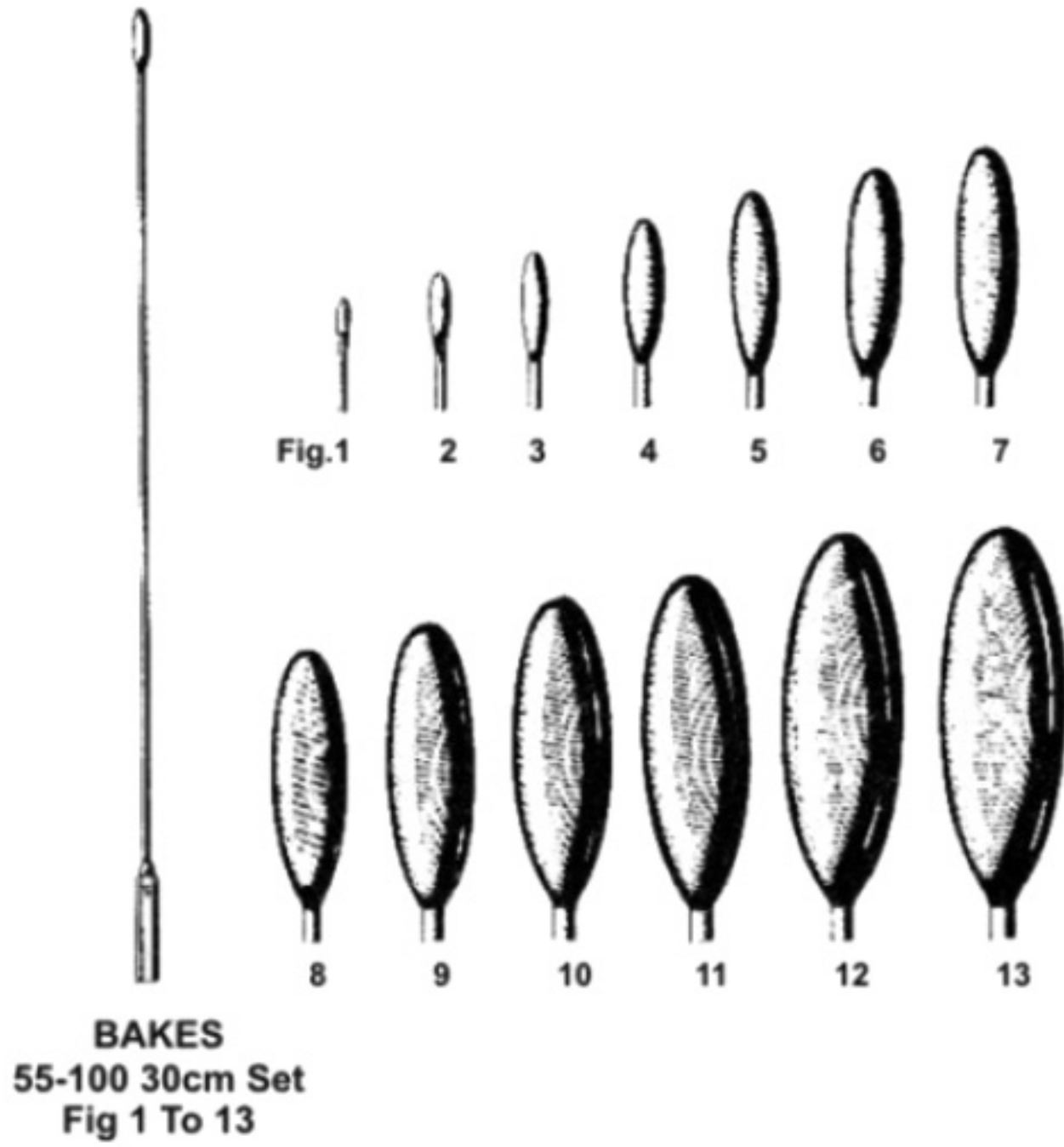

SCOOPS

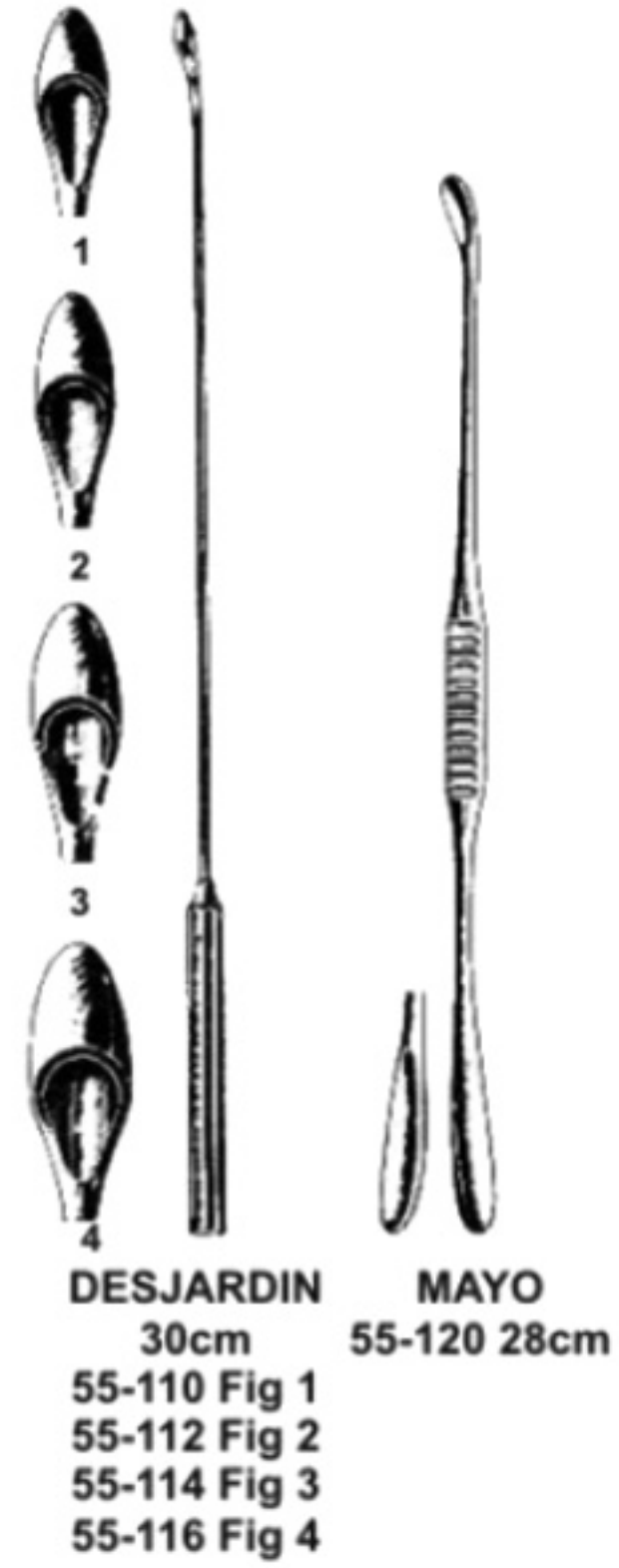

GALL STONE FORCEPS

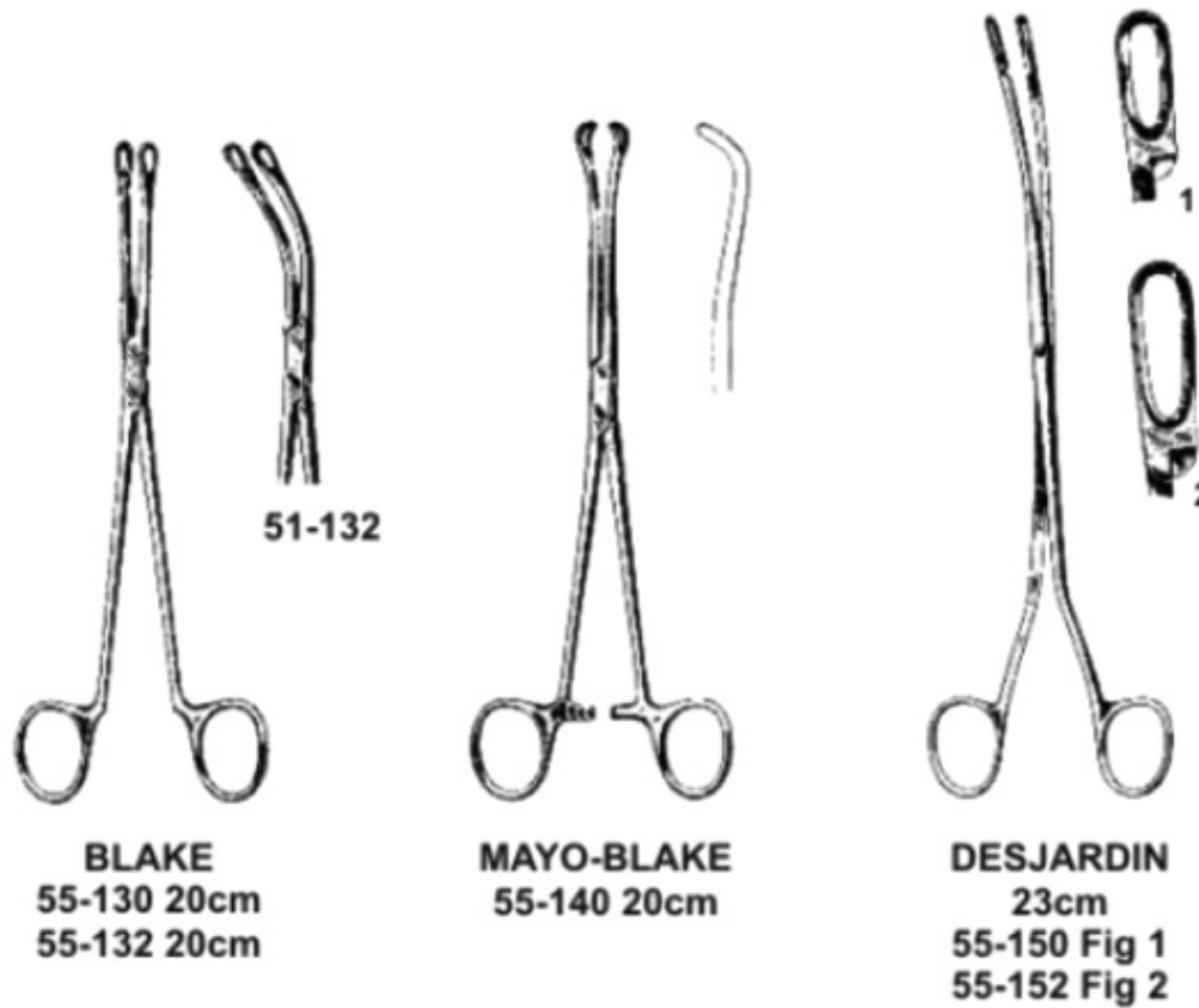



GALL BLADDER

KIDNEY FORCEPS

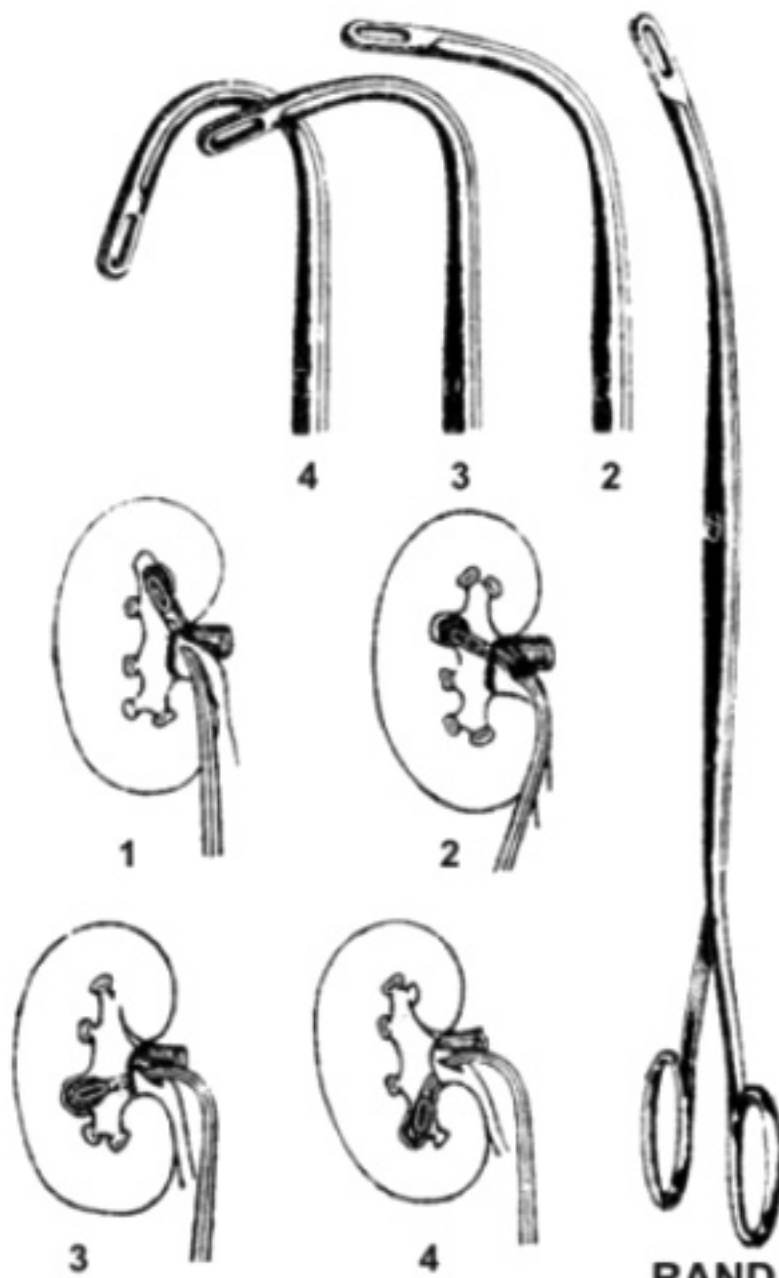

RANDALL
 55-160 Fig 1 23cm
 55-162 Fig 2 22cm
 55-164 Fig 3 22cm
 55-166 Fig 4 22cm

PROBE



MAYO
 55-170 32cm

CATHETERS



MERCIER
 57-100 23cm
 8 Fg To 24 Fg

UROLOGY CATHETERS



COXETER
 57-110 28cm
 8 Fg To 24 Fg



57-120 15cm
 10fg To 20Fg



57-130 20cm
 8fg To 24 Fg



UROLOGY

URETHRAL BOUGIES



LISTER
57-140
00/1 To 15/18



CLUTTON
57-150
6/10fg. To28/32f.g6 eg To 12 eg



STONE
57-160



WHEELHOUSE
57-170

DIRECTORS



CHILD
57-180

LITHOTOMY FORCEPS



KEY
57-190



LEWKOWITZ
57-200 26cm
57-202 26cm



57-202 26cm



YOUNG
57-210 20cm



UROLOGY

RETRACTORS



LEGUEU
57-220



MILLIN
57-230



MILLIN
57-240

SUCTION TUBE

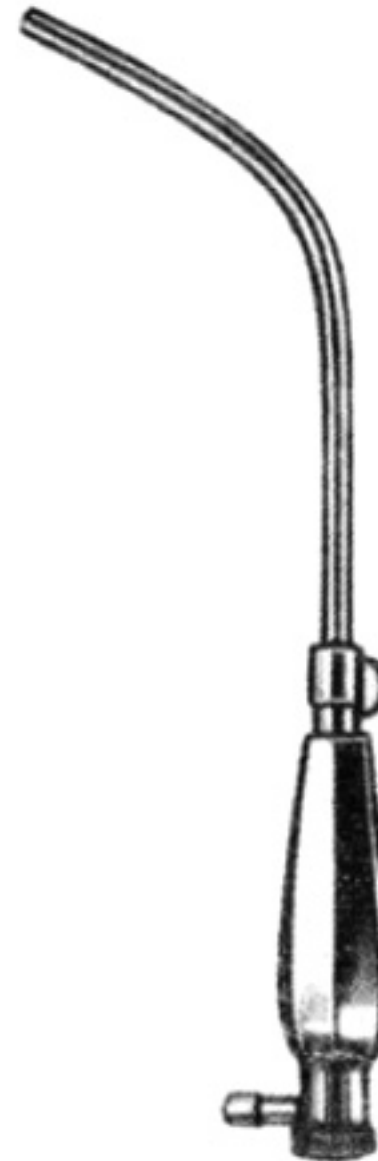

MILLIN
57-250

PROSTATECTOMY FORCEPS



MILLIN
57-260 23cm



57-270 23cm



MILLIN
57-280 23cm

URETHRAL FOREIGN BODY FORCEPS



MATHIEU
57-290 20cm
57-292 28cm



MATHIEU
57-230 20cm
57-202 28cm



GYNECOLOGY VAGINAL SPECULA



CUSCO
61-100 SMALL
61-102 MEDIUM
61-104 LARGE



CUSCO
61-110 SMALL
61-112 MEDIUM
61-114 LARGE

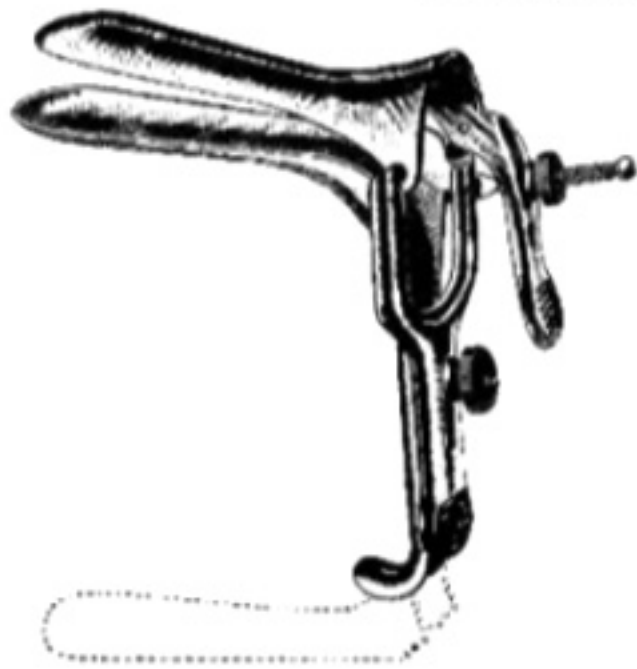

GRAVES
61-120 SMALL
61-122 MEDIUM
61-124 LARGE



COLLIN
61-130 SMALL
61-132 MEDIUM
61-134 LARGE



SIMS
61-140 SMALL
61-142 MEDIUM
61-144 LARGE



GYNECOLOGY VAGINAL SPECULA



KRISTELLER
61-150 SMALL
61-152 MEDIUM
61-154 LARGE



JACKSON
61-160 SMALL
61-162 MEDIUM
61-164 LARGE



EASTMAN
61-170 SMALL
61-172 MEDIUM
61-174 LARGE



KALLMORGEN
61-180 90x40mm

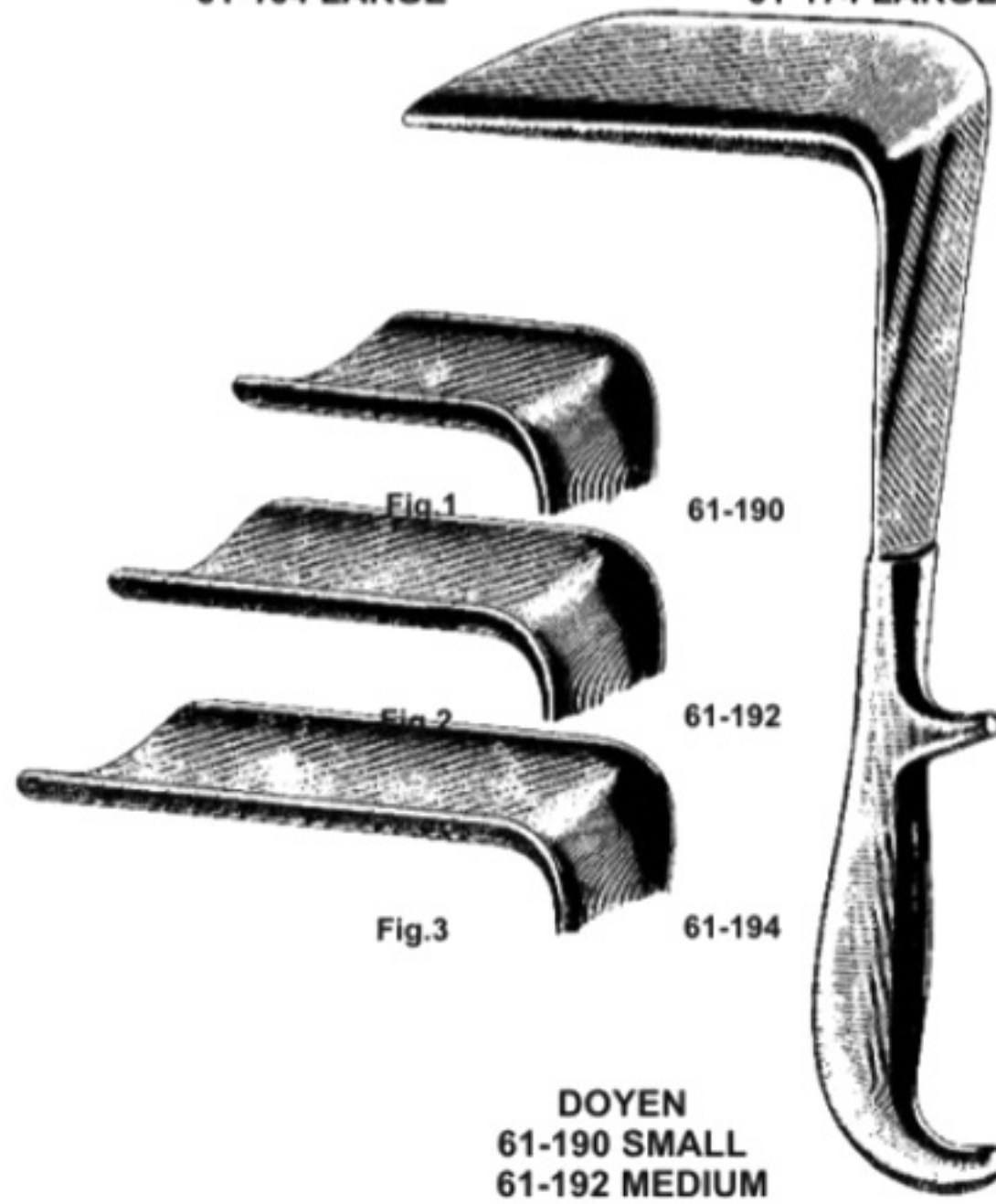

DOYEN
61-190 SMALL
61-192 MEDIUM
61-194 LARGE



GYNECOLOGY VAGINAL SPECULA



AUVAND
61-200 2 1/2Lbs
61-202 3 Lbs



AUVAND
61-210 3 Lbs



AUVAND
61-220 1/2Lbs
61-222 3 Lbs



65x30mm
75x35mm
85x35mm
95x35mm



85x30mm
85x33mm
100x38mm
110x42mm



A
BOZEMANN
61-230



B
BOZEMANN
61-240



BREISKY
61-250 100x20mm
61-251 100x25mm
61-252 100x30mm
61-253 100x35mm
61-254 100x40mm



LANDAU
61-260 100x28mm
61-262 100x38mm



FREDMANN
61-270 10cm



GYNECOLOGY UTERINE DILATORS



HEGAR
61-280 SET OF 14
4mm To 17mm



HEGAR
61-290 SET OF 8
1/4 To 17/8



HANK
61-300 SET OF 6
9/10 To 19/20



HAWKINS-AMBER
61-310 SET OF 16
3-6 To 18-21



JOLLY
61-320 SET OF 5
3-7 To 12-18



GYNECOLOGY UTERINE DILATORS

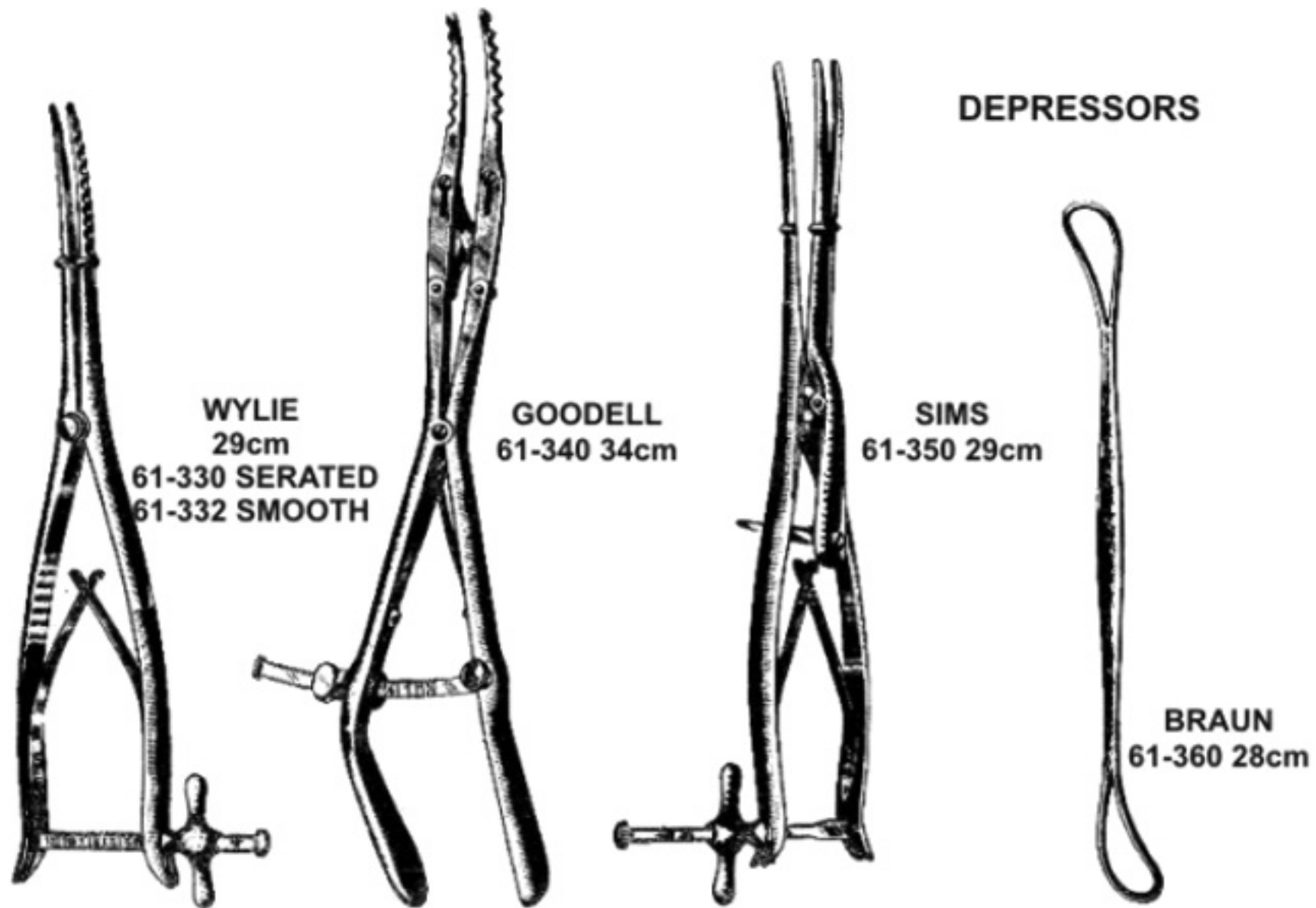

DEPRESSORS

UTERINE SOUNDS

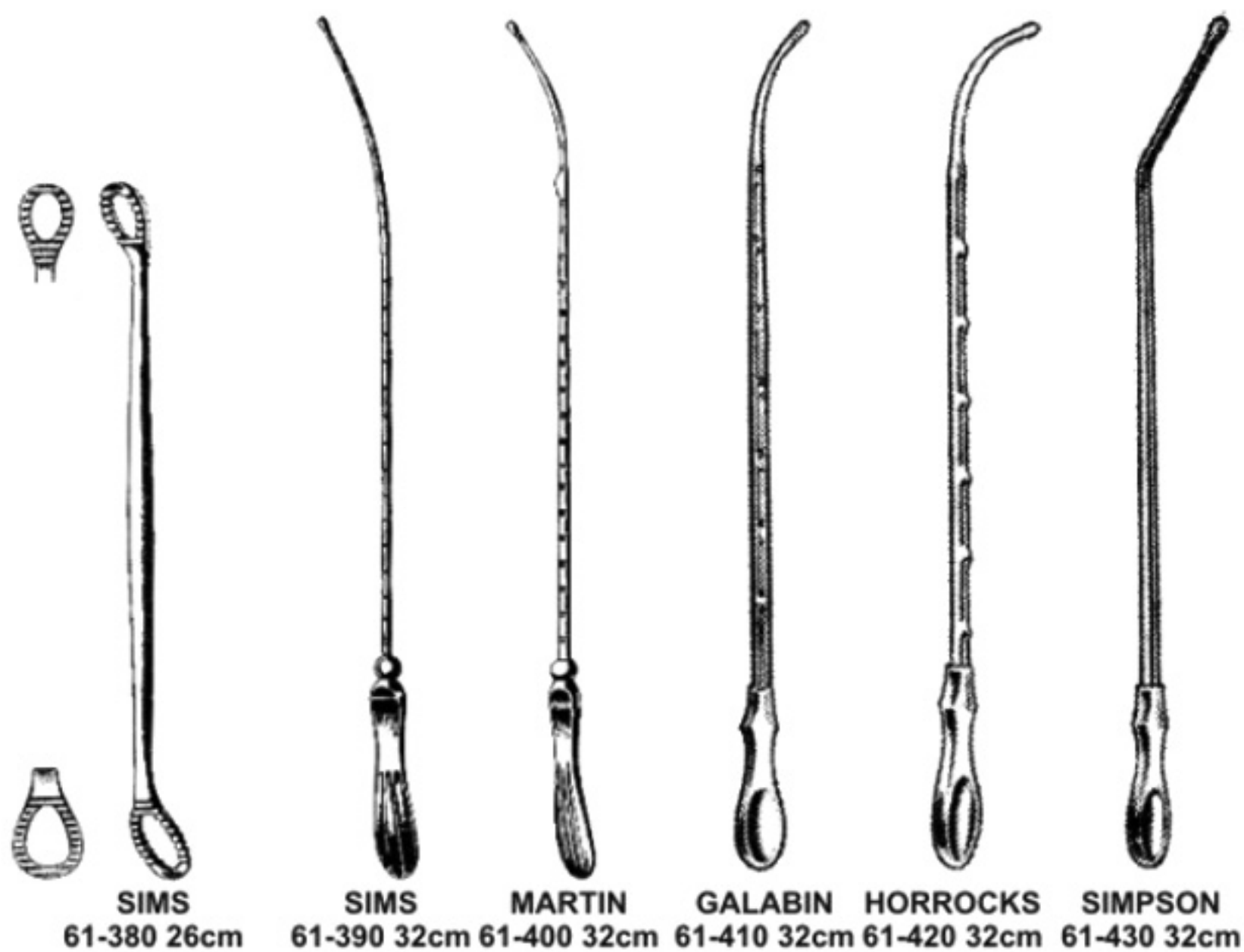



GYNECOLOGY TENACULUM FORCEPS



SCHROEDER
61-440 25cm



SCHROEDER
61-450 25cm



STAUDE-MODRE
61-460 17cm



SKENE
61-470 23cm



BRAUN
61-480 25cm



SKENE
61-490 24cm



POZZI
61-500 25cm



DUPLAY
61-510 28cm



GYNECOLOGY VULLSELLUM FORCEPS



TEALE
61-520 18cm
61-522 23cm



TEALE
61-530 23cm



SCHROEDER
61-540 24cm
61-542 24cm
61-544 24cm



61-542



61-544



SKENE
61-550 26cm



MUSEUX
24 cm

STR	CUR
61-560 9mm	61-570
61-562 11mm	61-572
61-564 13mm	61-574



6mm



8mm



10mm



MUSEUX
24 cm

STR	CUR
61-580 9mm	61-590
61-582 11mm	61-592
61-584 13mm	61-594



9mm



11mm



13mm



GYNECOLOGY

VULLSELLUM FORCEPS



MUSEUX
STR 24 cm cur
61-600 6mm 61-610
61-602 8mm 61-612
61-604 10mm 61-614



MUSEUX
61-620 20.5cm



JACOBS
61-630 21cm
61-632 21cm



PRATT
61-640 28cm

HYSTERECTOMY FORCEPS



MAINGOT
61-650 20cm
61-652 24cm



BERKLEY BONNEY
61-660 19cm



BONNEY
61-670 27cm



BONNEY
61-680 35cm



GYNECOLOGY

POLYPUS FORCEPS



NOTO
61-690 27cm



KELLY
61-700 32cm

ELEVATING FORCEPS



DARTIGUES
61-710 27cm



COLLIN
61-720 25cm

BIOPSY



SOMER
61-730 23cm



THOMAS-GAYLOR
61-740 22cm
61-742 24cm



SCHUBERT
61-750 26cm



GYNECOLOGY UTERINE BIOPSY FORCEPS



FAURE
61-760 24cm

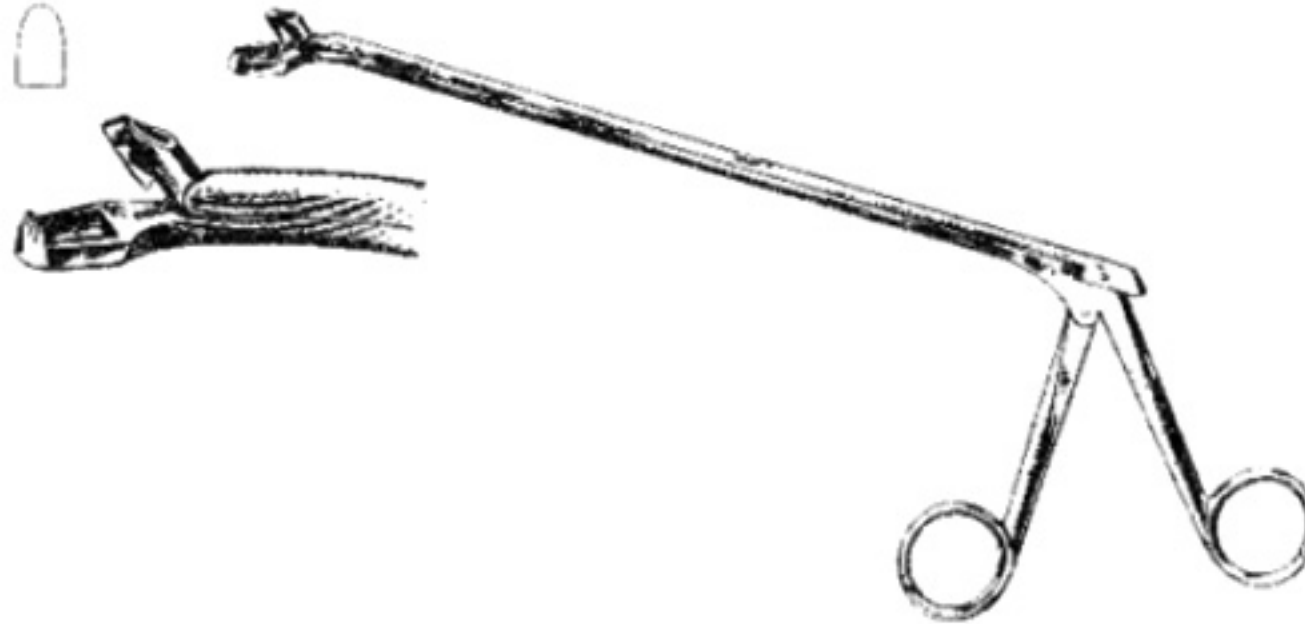

WITTNER
61-770 23cm



VAN-DOREN
61-780

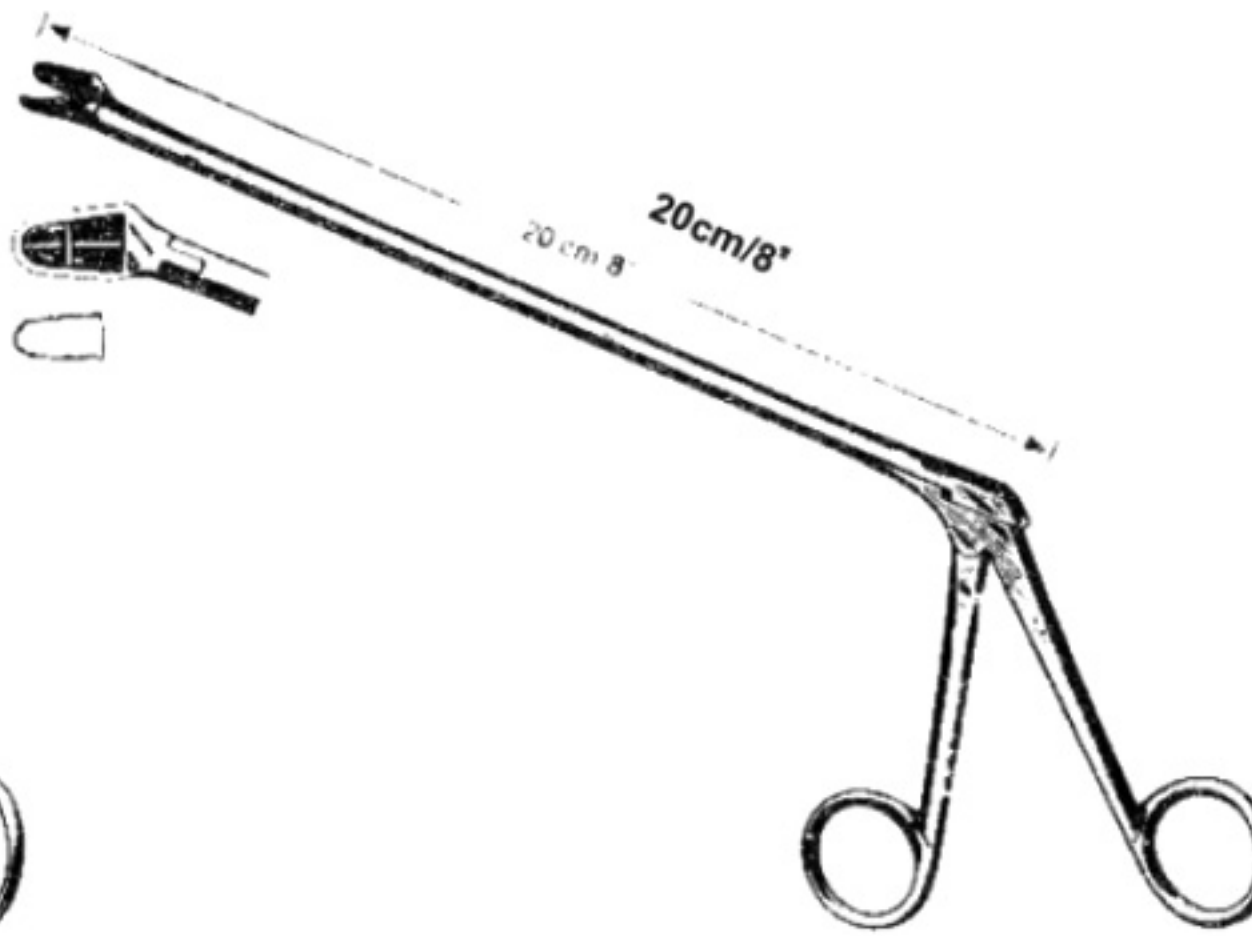

ALEXANDER
61-790 28cm



GYNECOLOGY UTERINE CURETTES



BLAKE
61-800 27cm

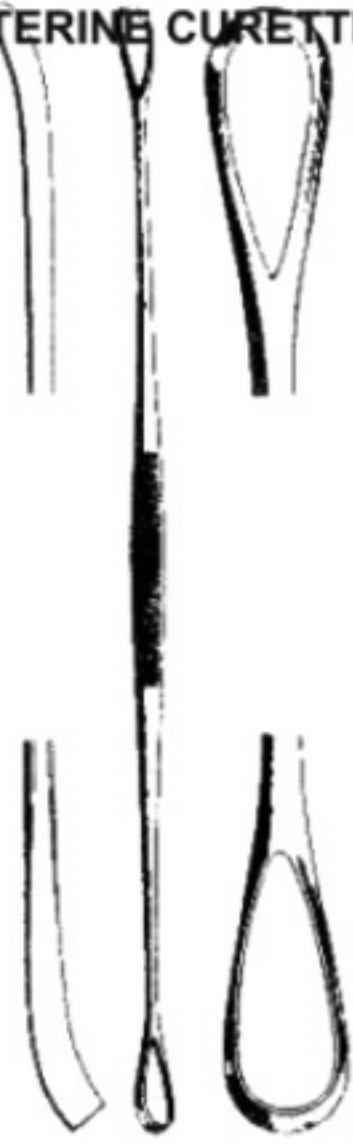

ZWEIFEL
61-810 31cm



SIMS
25cm



5 6



RECAMIER **RECAMIER**
26cm 31cm
61-830 SHARP Fig 1 to 10 61-850
61-840 BLUNT Fig 1 to 10 61-860

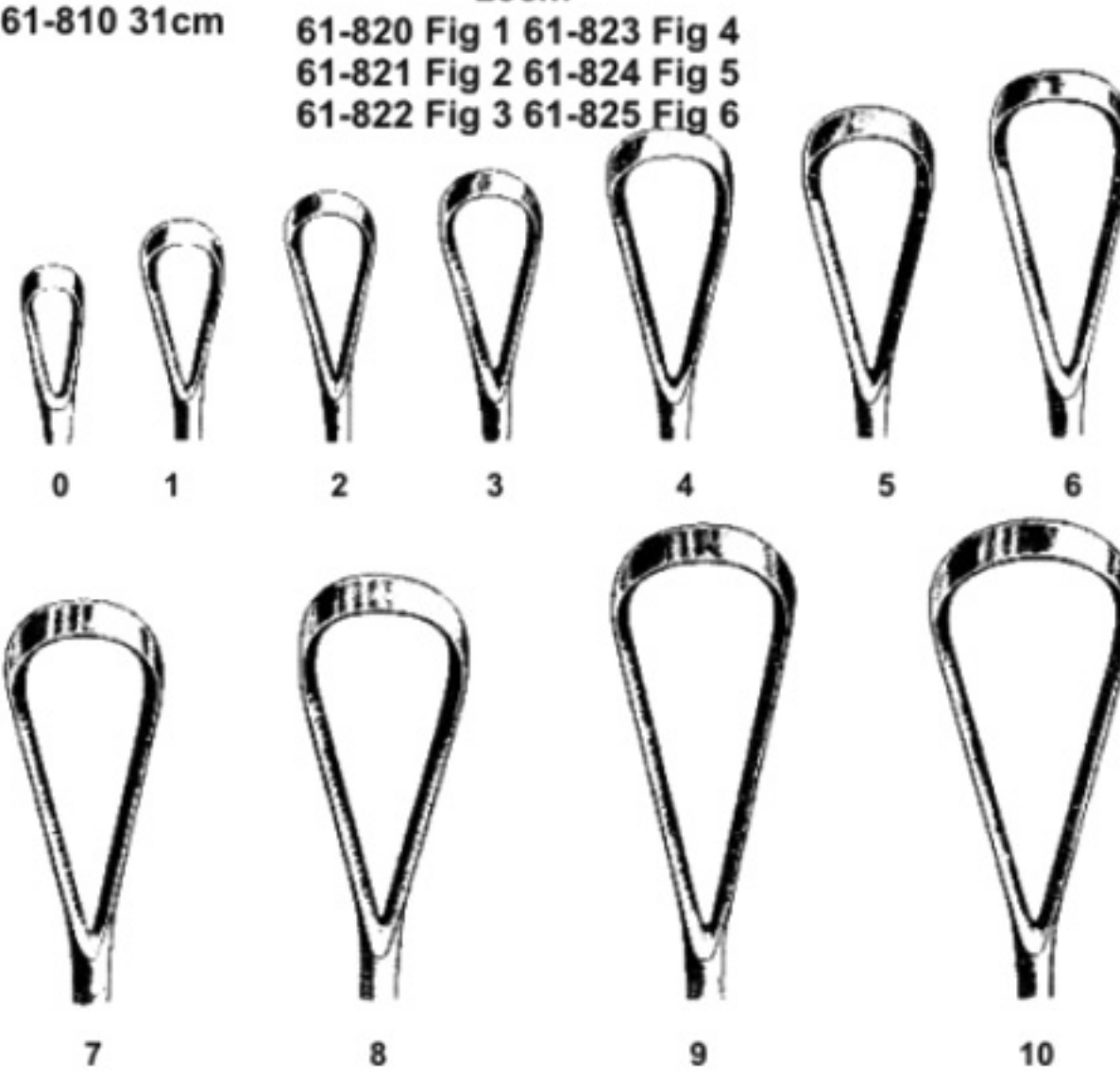

61-820 Fig 1 61-823 Fig 4
61-821 Fig 2 61-824 Fig 5
61-822 Fig 3 61-825 Fig 6



GYNECOLOGY UTERINE CURETTES



SIMS
25cm
61-870 SHARP Fig 1 to 6
61-880 BLUNT Fig 1 to 6

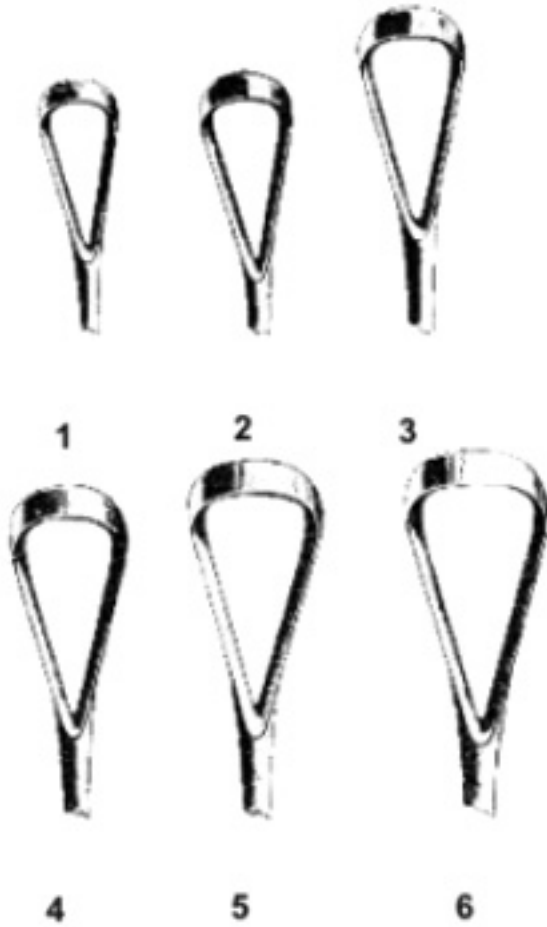

THOMAS
28cm
61-890 SHARP Fig 1 to 6
61-900 BLUNT Fig 1 to 6

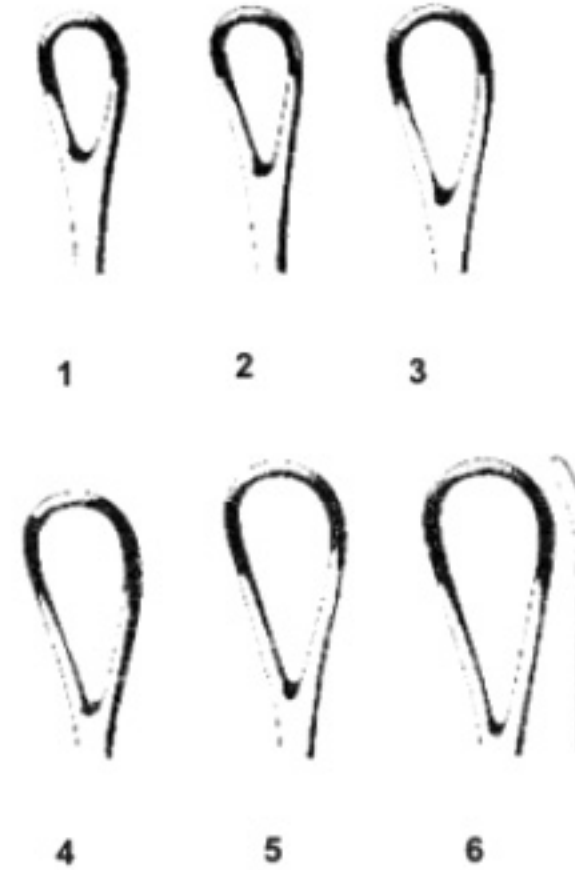

RHEINSTATER
61-910 29cm SHARP
61-920 29cm BLUNT



CHELSEA
61-930 31cm



RANDALL
61-940 24cm



NOVAK
61-950 23cm



SHARMAN
61-960 23cm

MOYOMA SCREW



DOYEN
61-970



OBSTETRICS OBSTETRICAL FORCEPS



DE-LEE
63-100 39cm



DE-LEE
63-110 36cm



DE-LEE
63-120 30cm



SIMPSON
63-130 30cm

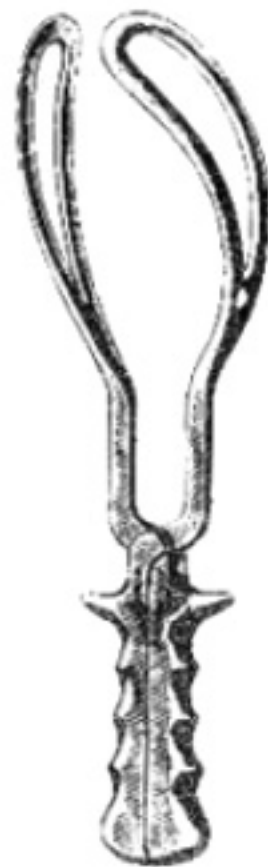

SIMPSON-BRAUN
63-140 33cm
63-142 36cm



WRIGLEY
63-150 27cm



KILLAND
63-160 41cm



ELLIOT
63-170 32cm
61-172 38cm



OBSTETRICS OBSTETRICAL FORCEPS



NAEGELE
63-180 36cm
63-182 40cm



KEDARNATH DAS
63-190 33cm



PIPER
63-200 44cm



BOERMA
63-210 29cm



KIELAND-LUIKART
63-220 40cm



SIMPSON-LUIKART
63-230 36cm



McLEAN
63-240 36cm



McLEAN-TUCKER
63-250 39cm



OBSTETRICS OBSTETRICAL FORCEPS

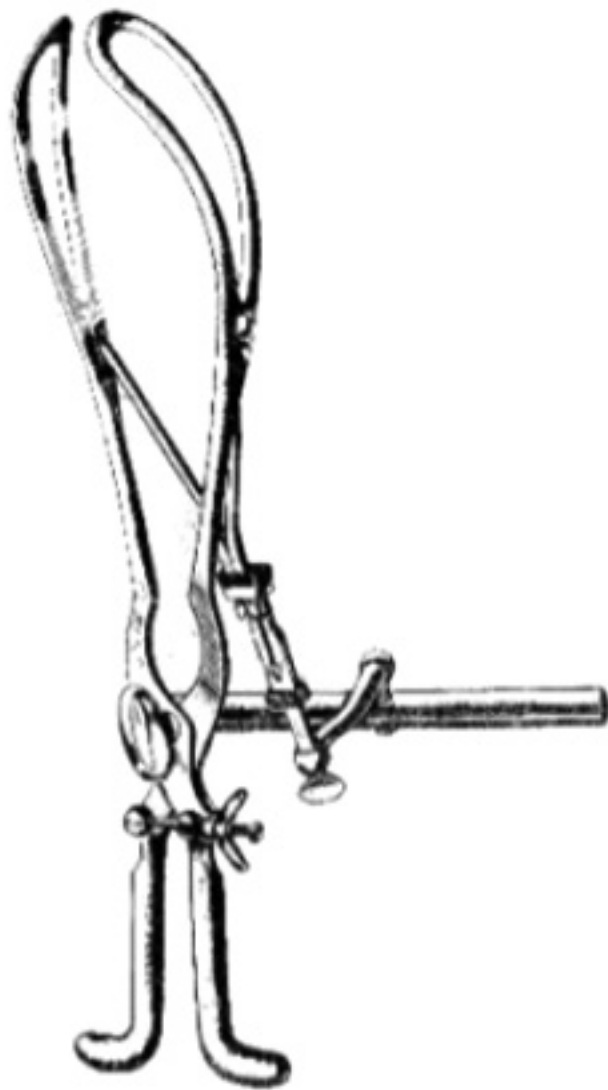

TARNIER
63-260 38cm
63-262 40cm
63-264 42cm



KEDARNATH DAS
63-270 38cm



DEWEY
63-280 37cm



BARNES-NEVILLE-SIMPSON
63-290



BARNES-NEVILLE
63-300

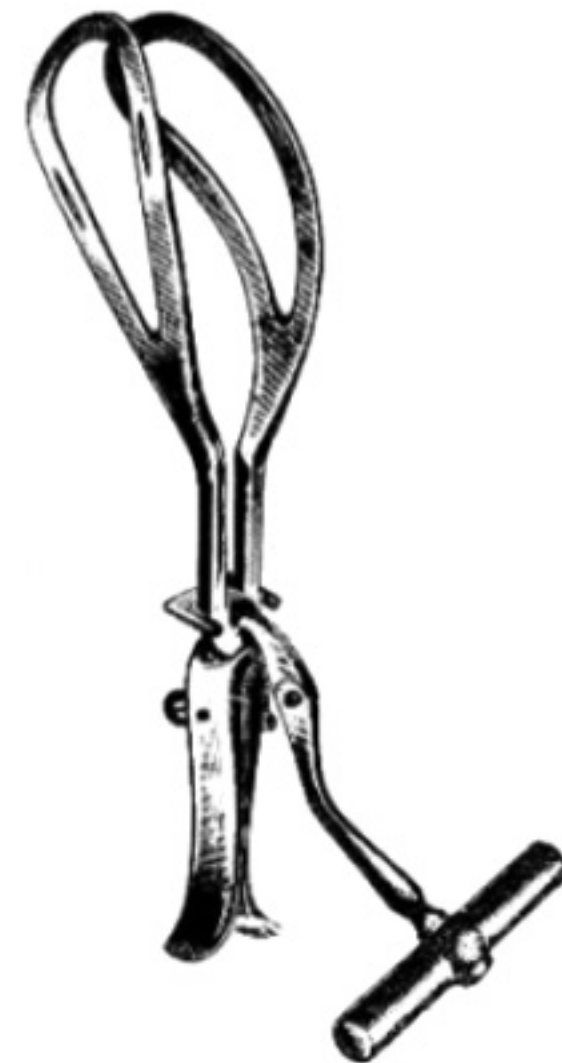

HAIG-FERGUSON
63-310



OBSTETRICS CRANIOCLAST

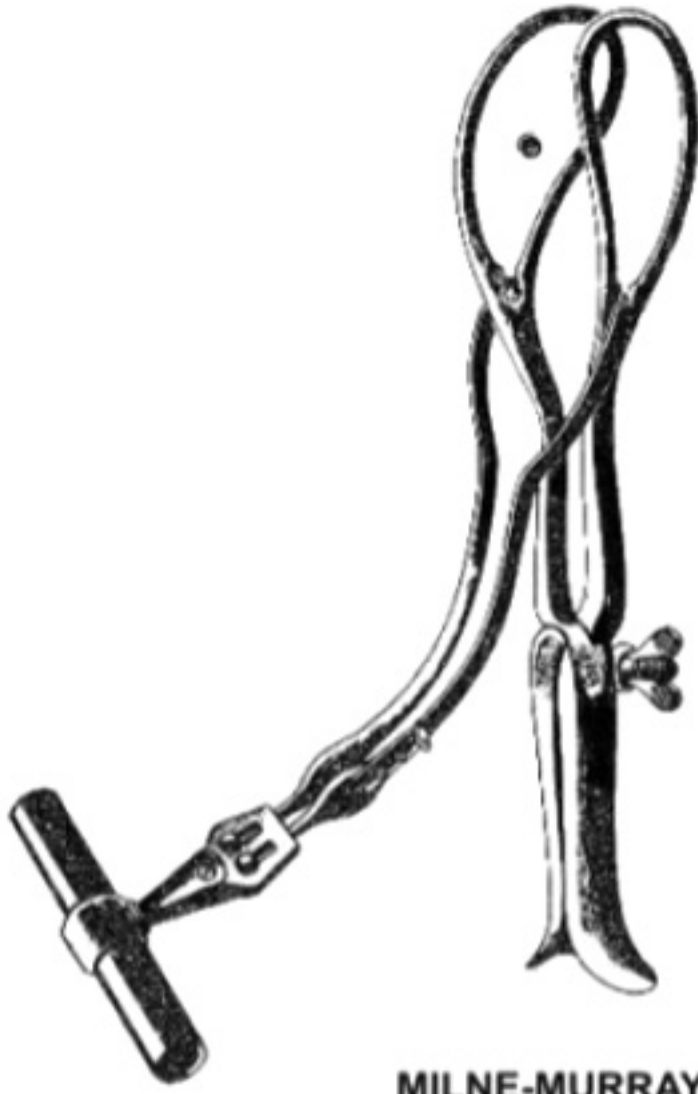

MILNE-MURRAY
63-320

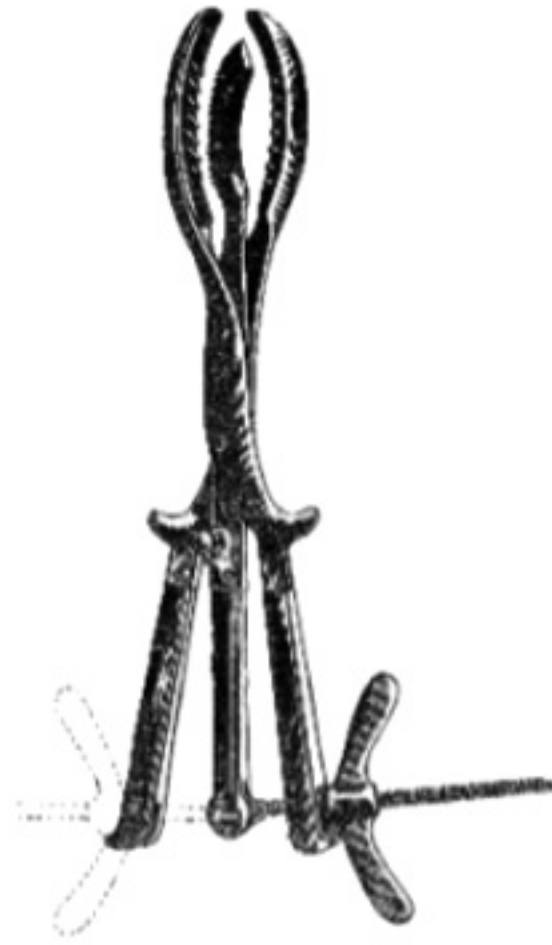

WINTER
63-330



AUVARD-ZWEIFEL
63-340 46cm

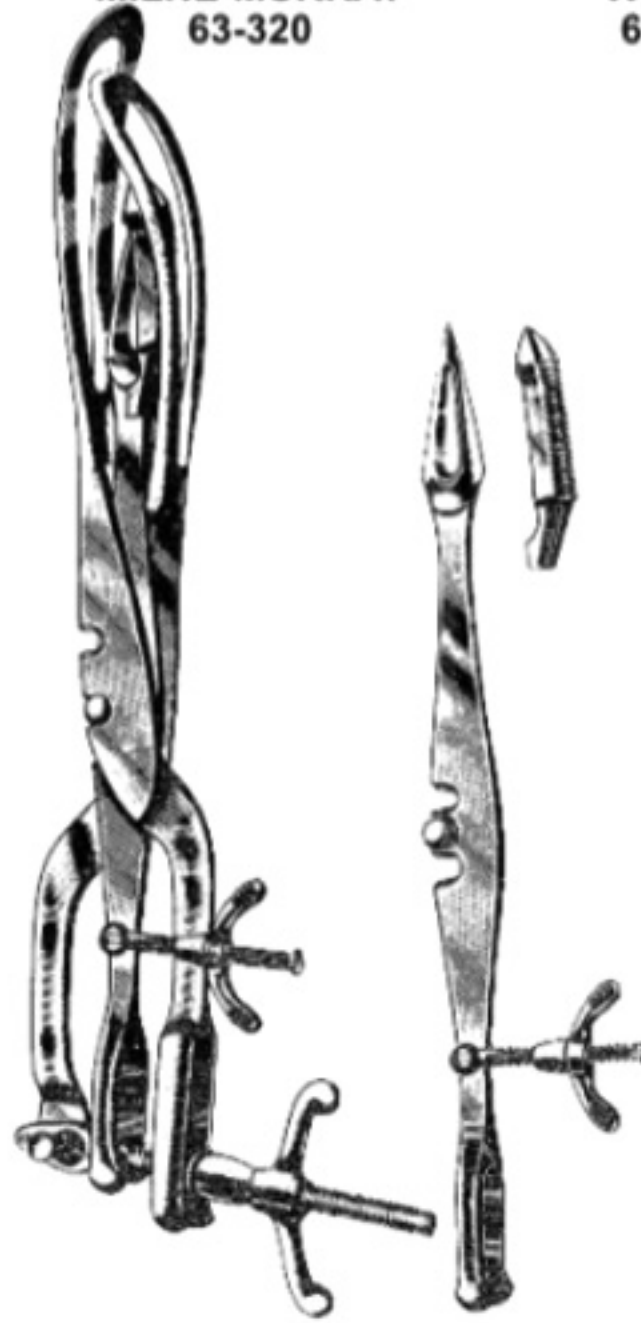

TARNIER
63-350 46cm



BRAUN
63-360 42cm



OBSTETRICS

PERFORATORS

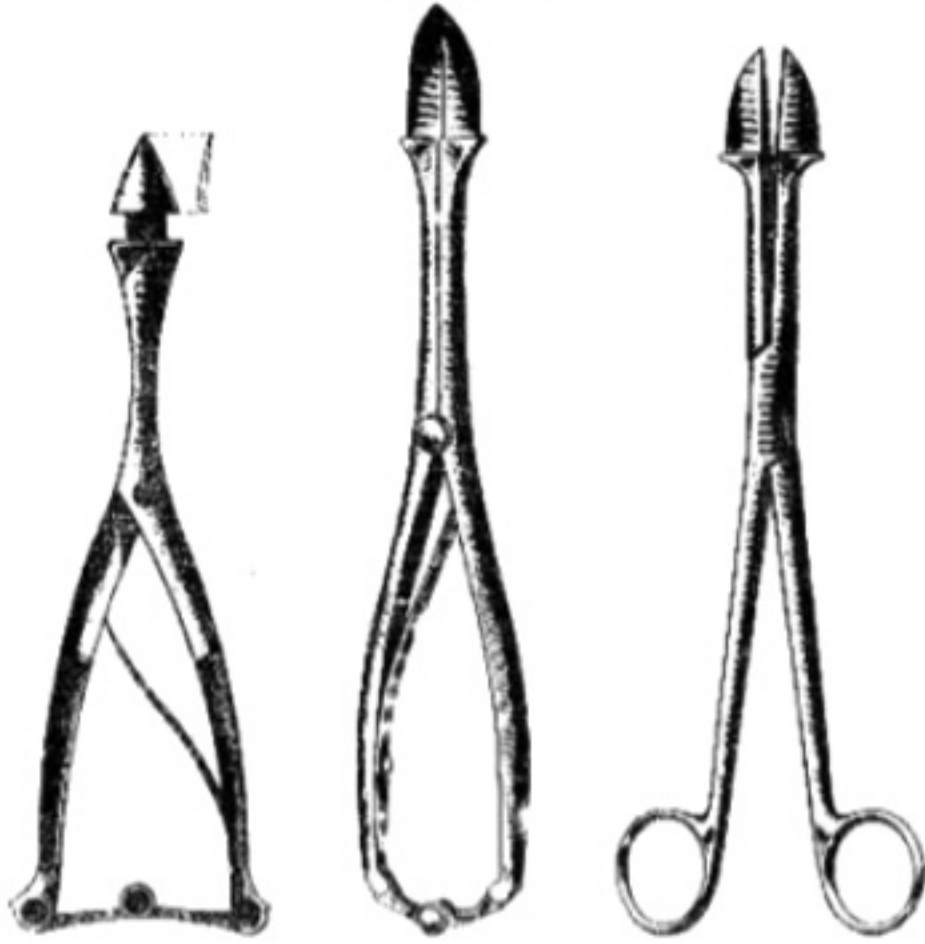

SIMPSON
63-370 30cm

NAEGELE
63-380 25cm

SPELLIE
63-380 25cm

HOOKS

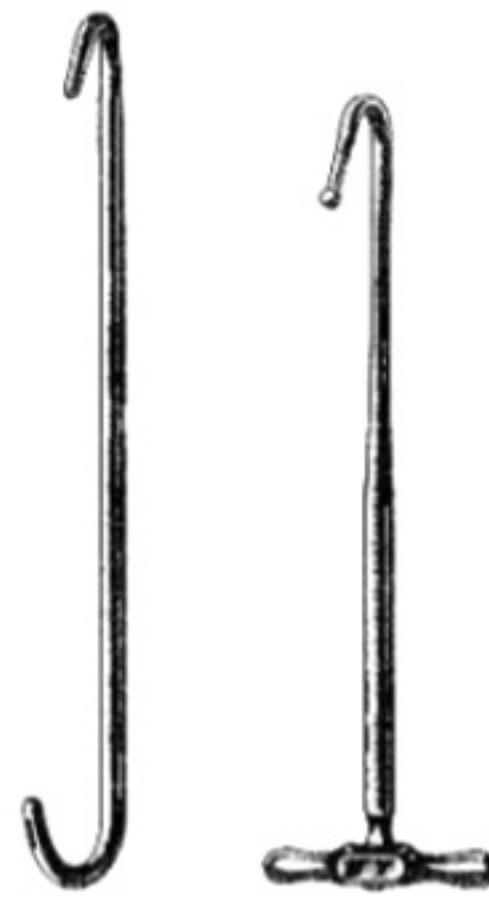

SPELLIE
63-400 33cm

BRAUN
63-410 30cm

HOOKS



63-420 26cm

TARGET
63-430 30cm

PELVIMETERS



MARTIN
63-440 33cm

COLLIN
63-450 35cm



PERFORATORS **OBSTETRICS**



COLLYER
63-460 30cm



BREISKY
63-470 33cm

UMBILICAL CLAMP

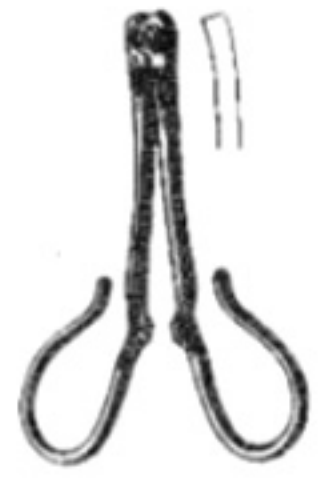

KANE
63-480 8.5cm

PLACENTA FORCEPS

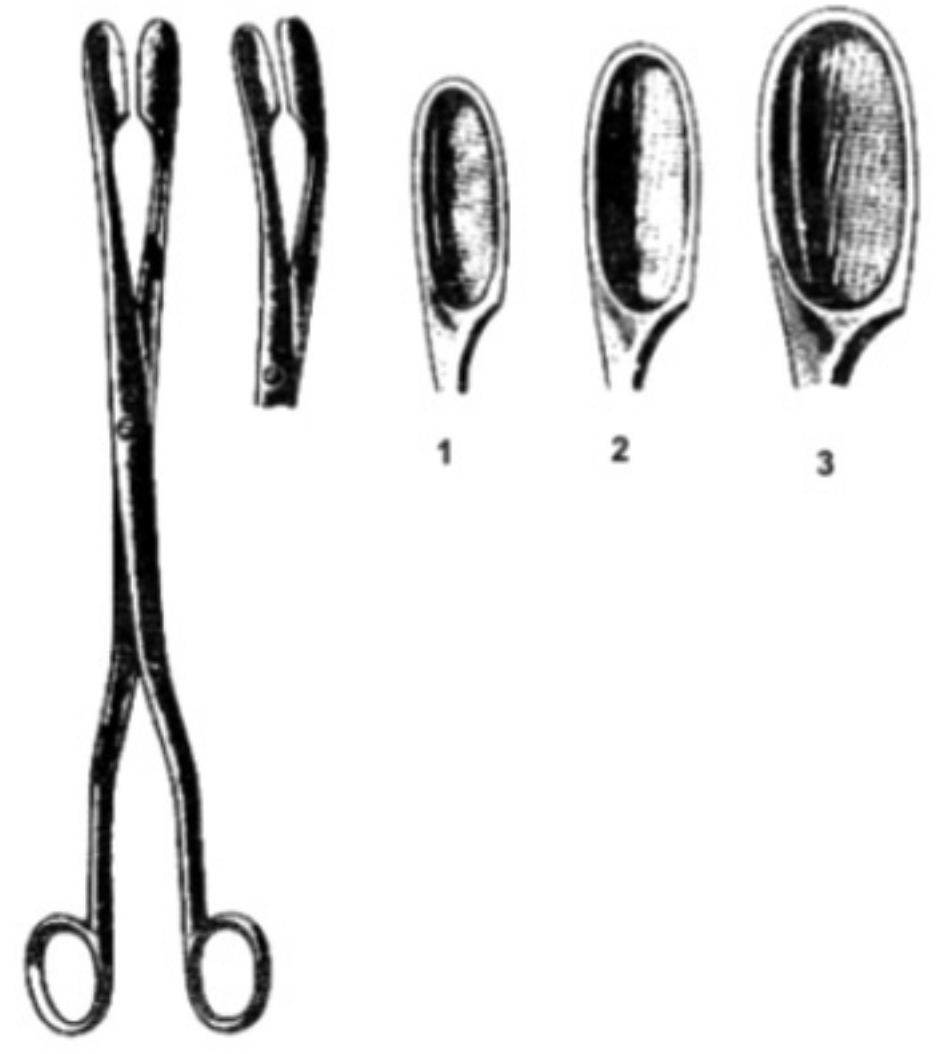

WINTER
STR 28cm CUR
63-490 Fig 1 63-500
63-492 Fig 2 63-502
63-494 Fig 3 63-504

OVUM FORCEPS



HEYWOOD-SMITH
63-510 25.5cm

COREY
63-520 24cm



OBSTETRICS

PLACENTA AND HAEMOSTATIC FORCEPS



SAENGER
63-530 27cm
63-532 27cm



WILLET
63-540 19cm



GREEN-ARMYTAGE
63-550 21cm

CATHETERS AND TUBES



CARTON
63-560 30cm



BOZEMANN-FRITSCH
63-570 8mm Ø
63-572 10mm Ø
63-574 12mm Ø



DREW SYMTH
63-580



PROVIS
63-590



SPACKMANN
63-600 18cm



STERILIZATION STERILIZING FORCEPS



CHEATLE
65-100 27cm



CHEATLE
65-110 27cm



CHEATLE
65-120 28cm



LONDON PATT
65-130 28cm



HARRISON
65-140 25cm
65-142 30cm
65-144 36cm
65-146 46cm



65-150 20cm
65-152 30cm



DAVIS
65-160 16cm
65-162 20cm
65-164 24cm

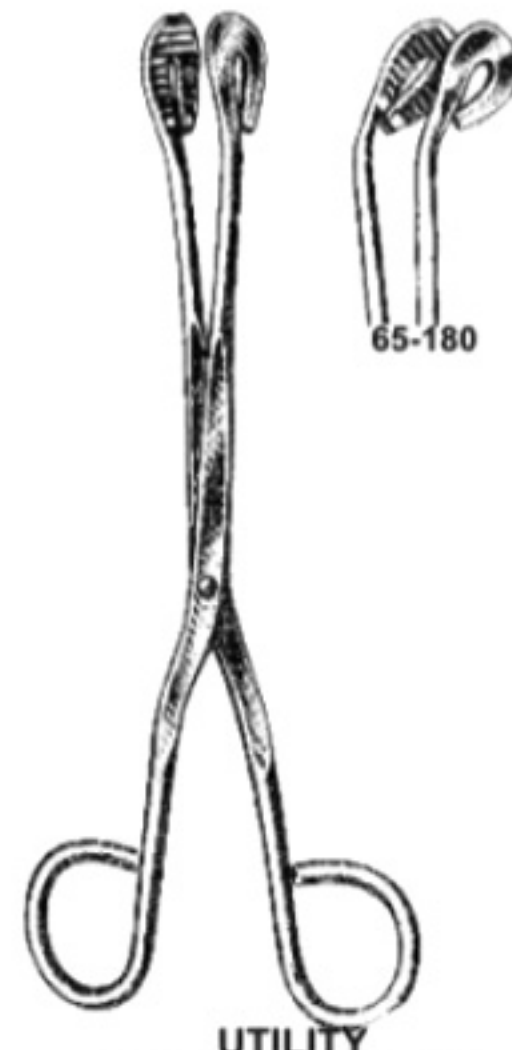

UTILITY
65-170 20cm 65-180
65-172 28cm 65-182

65-180



ORTHOPAEDIC

BONE SCREW AND PLATE HOLDING FORCEPS

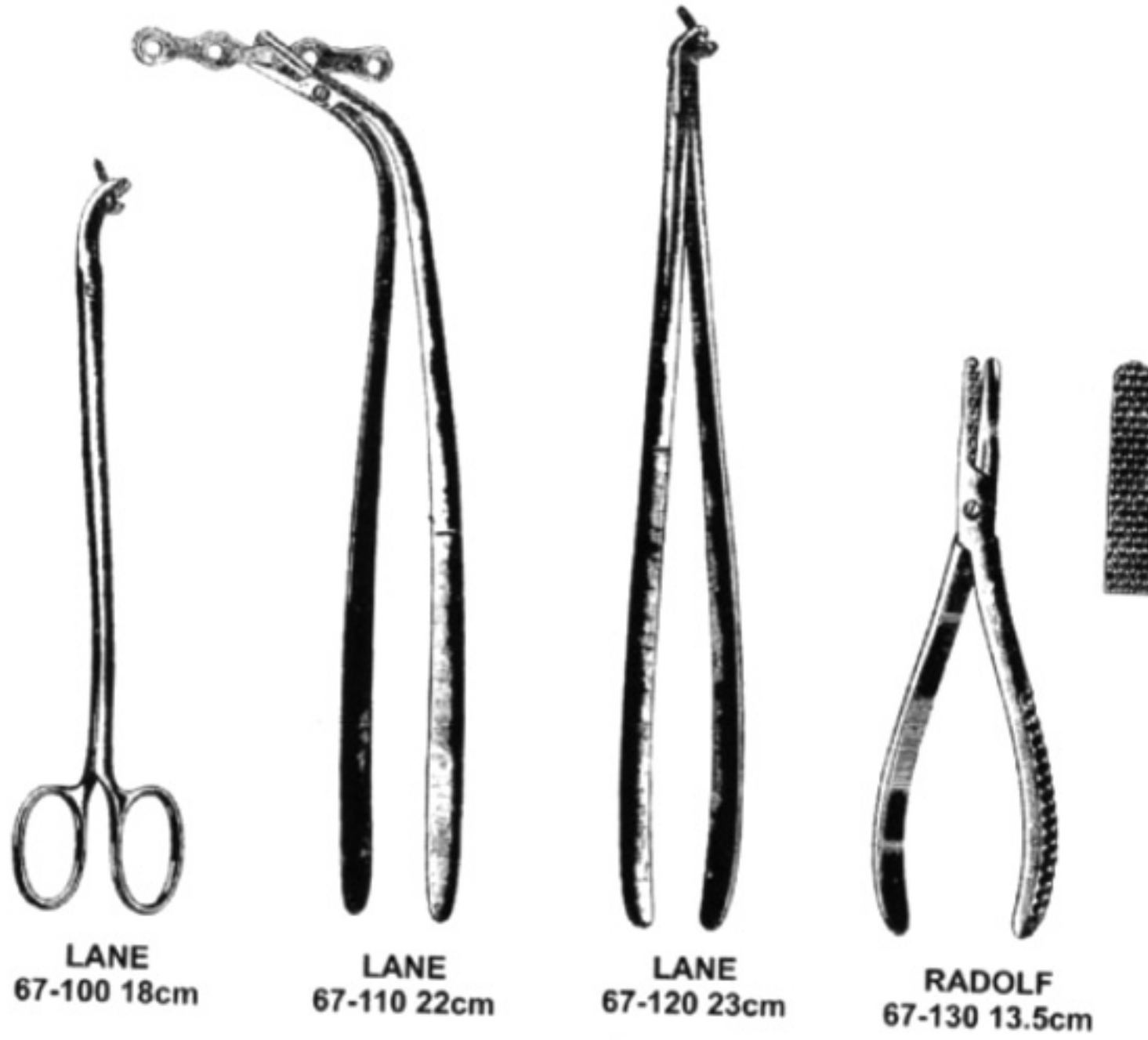

EXTENSION BOWS BONE WIRE TIGHTENERS

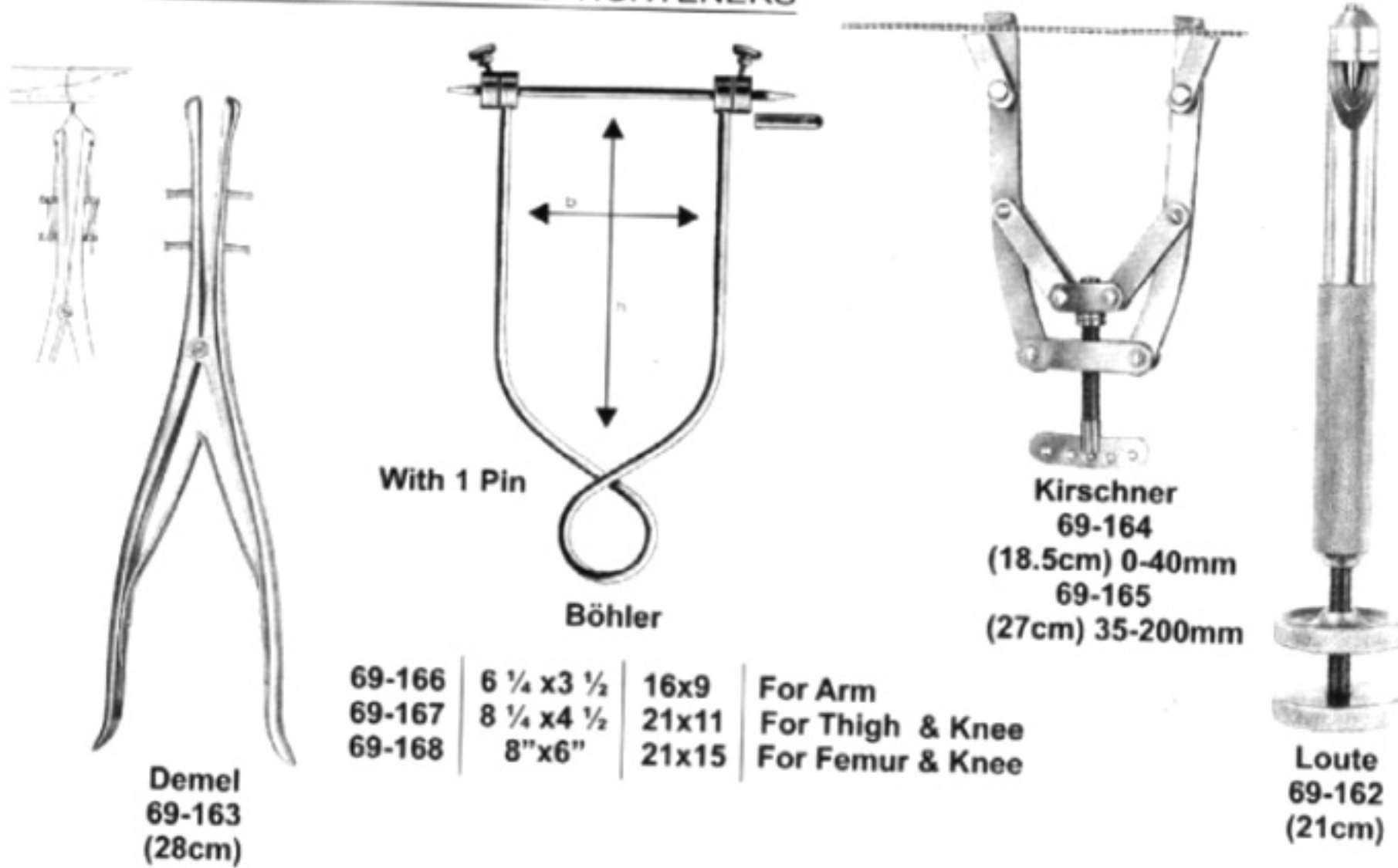



GENERAL INSTRUMENTS

CUTICAL & NAIL SCISSORS



BEAUTY CARE

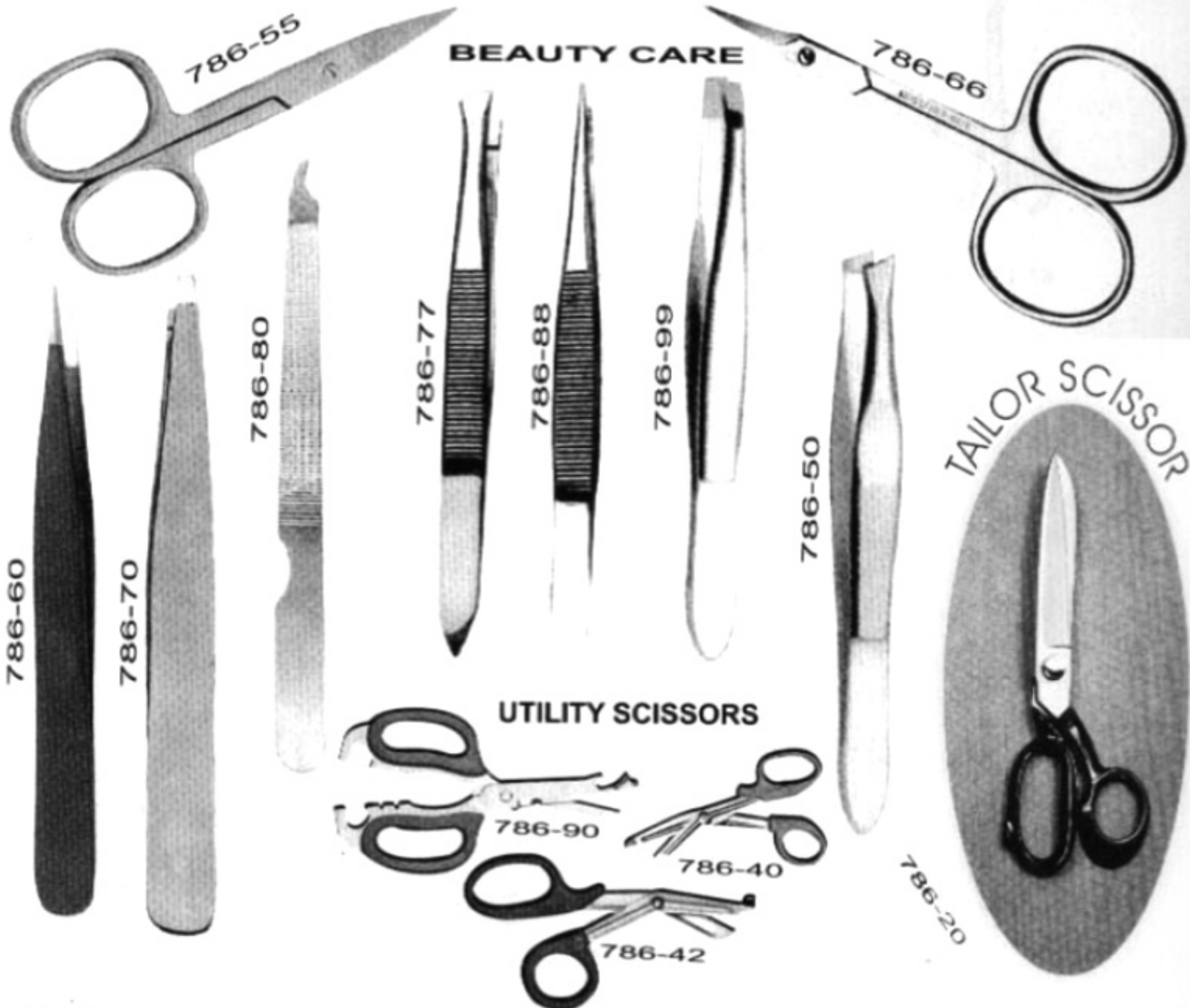

130

All Items Are Available In Half Gold, Full Gold, Mirror & Satin Finish In All Sizes



GENERAL INSTRUMENTS

BARBER SCISSORS



(All Items Are Available In Half Gold, Full Gold, Mirror & Satin Finish In All Sizes)



GENERAL INSTRUMENTS CUTICLE & NAIL NIPPERS

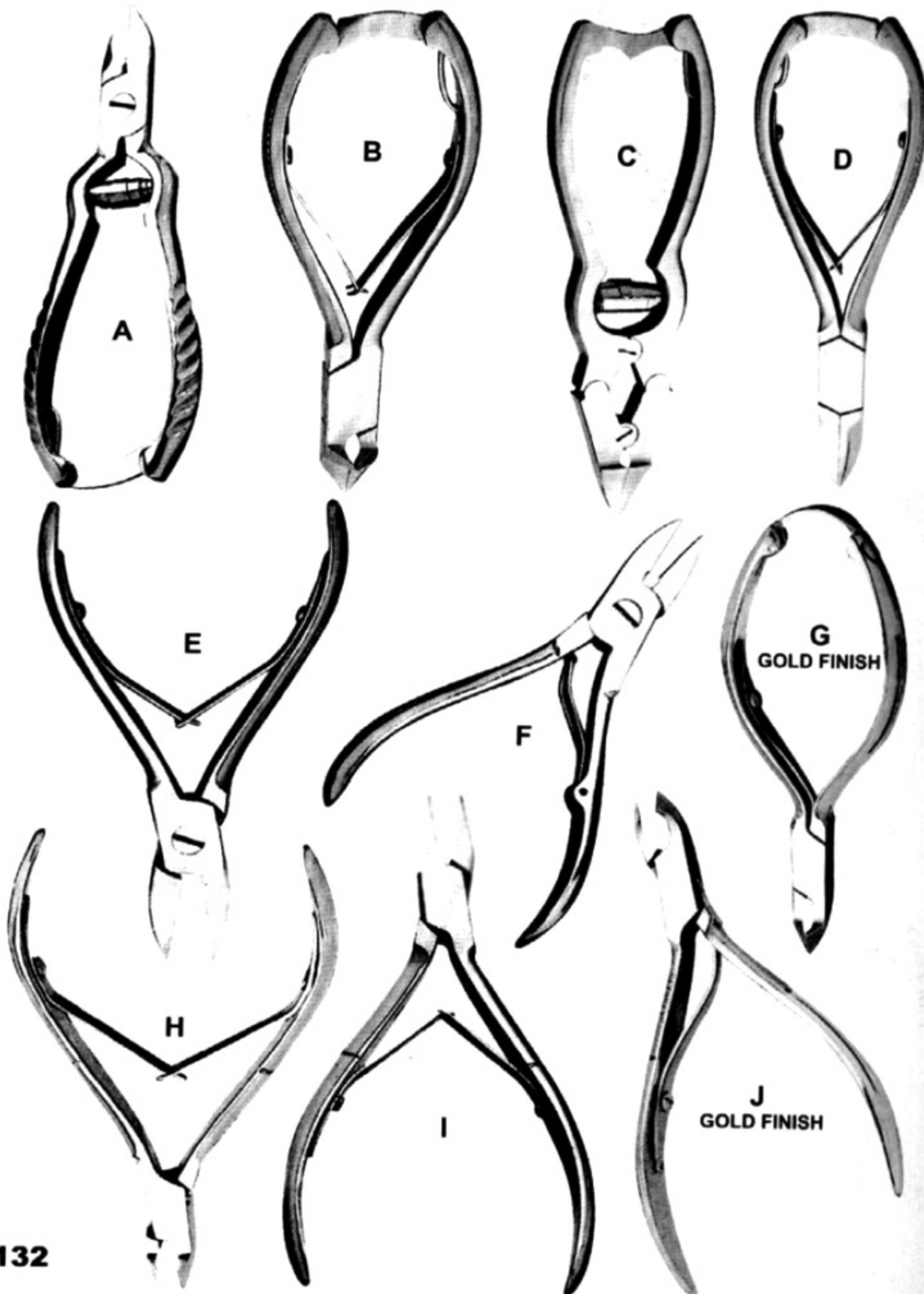

132

(All Items Are Available In Half Gold, Full Gold, Mirror & Satin Finish In All Sizes)



Manicure & Barber Kits

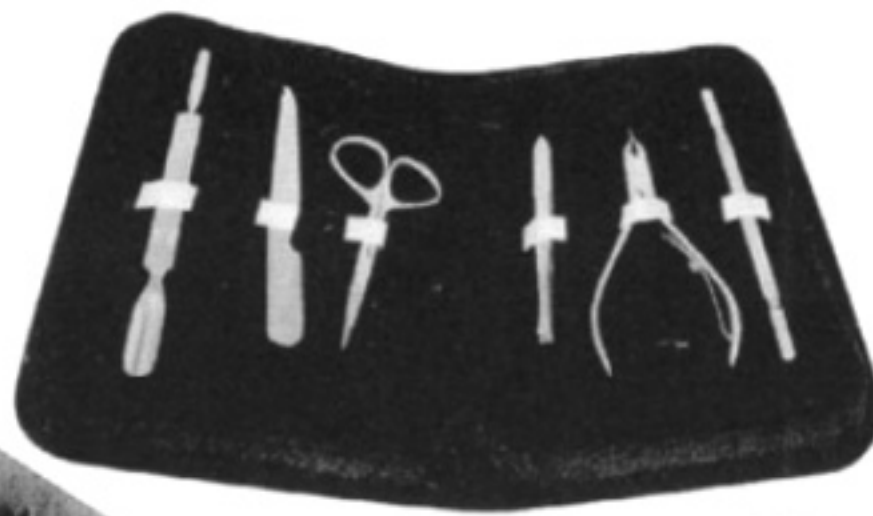

M-101

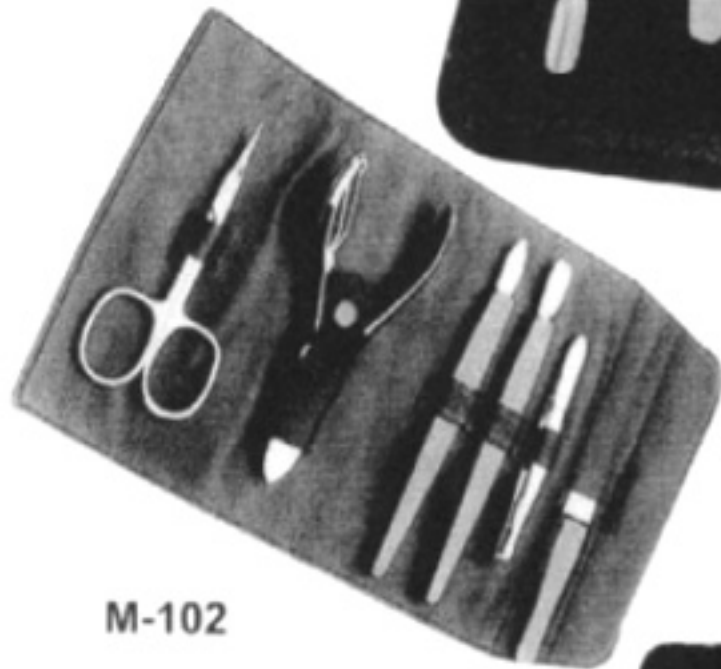

M-102

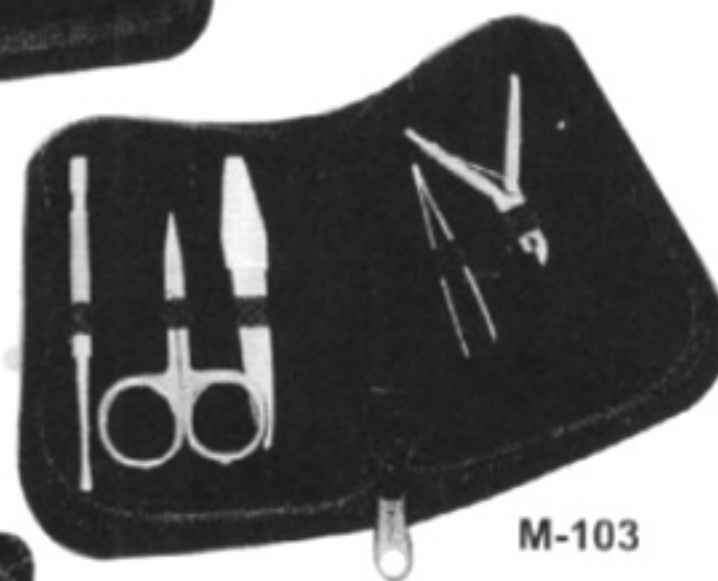

M-103



B-105



B-106



B-108

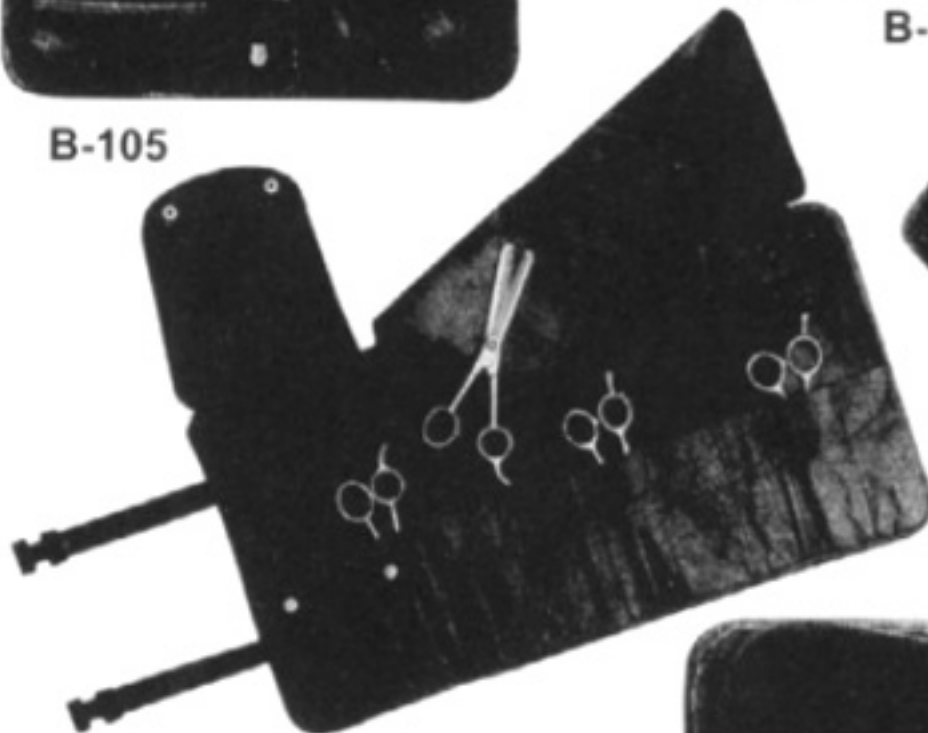

B-107

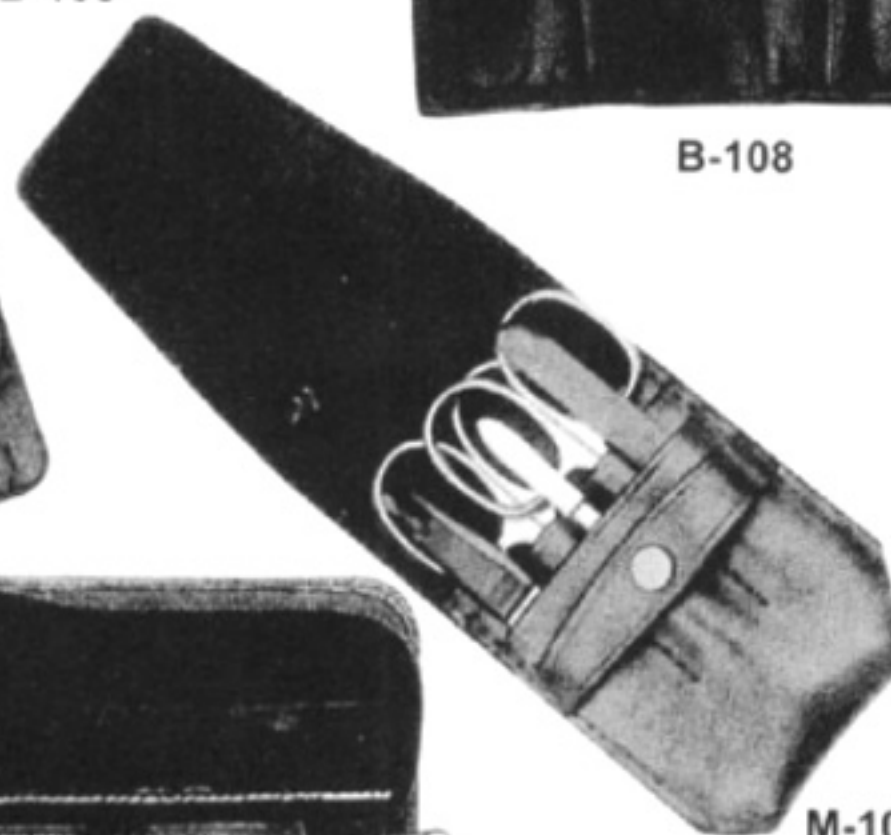

M-104

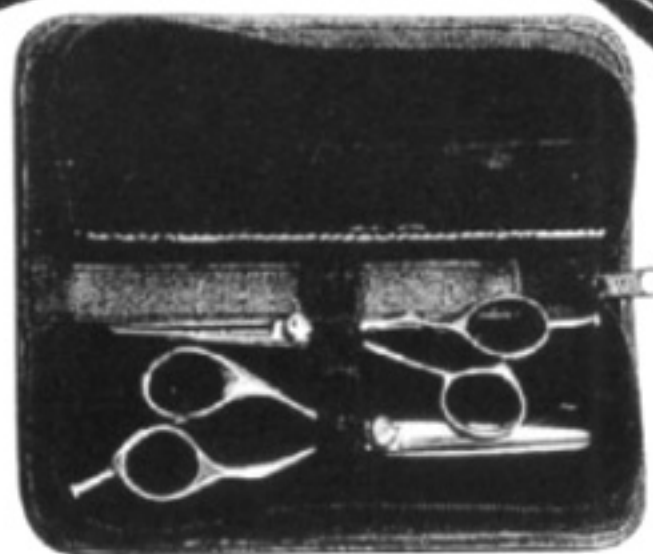

B-109



**78-1485
STERILIZING DRUM**



**78-1486
ELECTRIC STERILIZER**

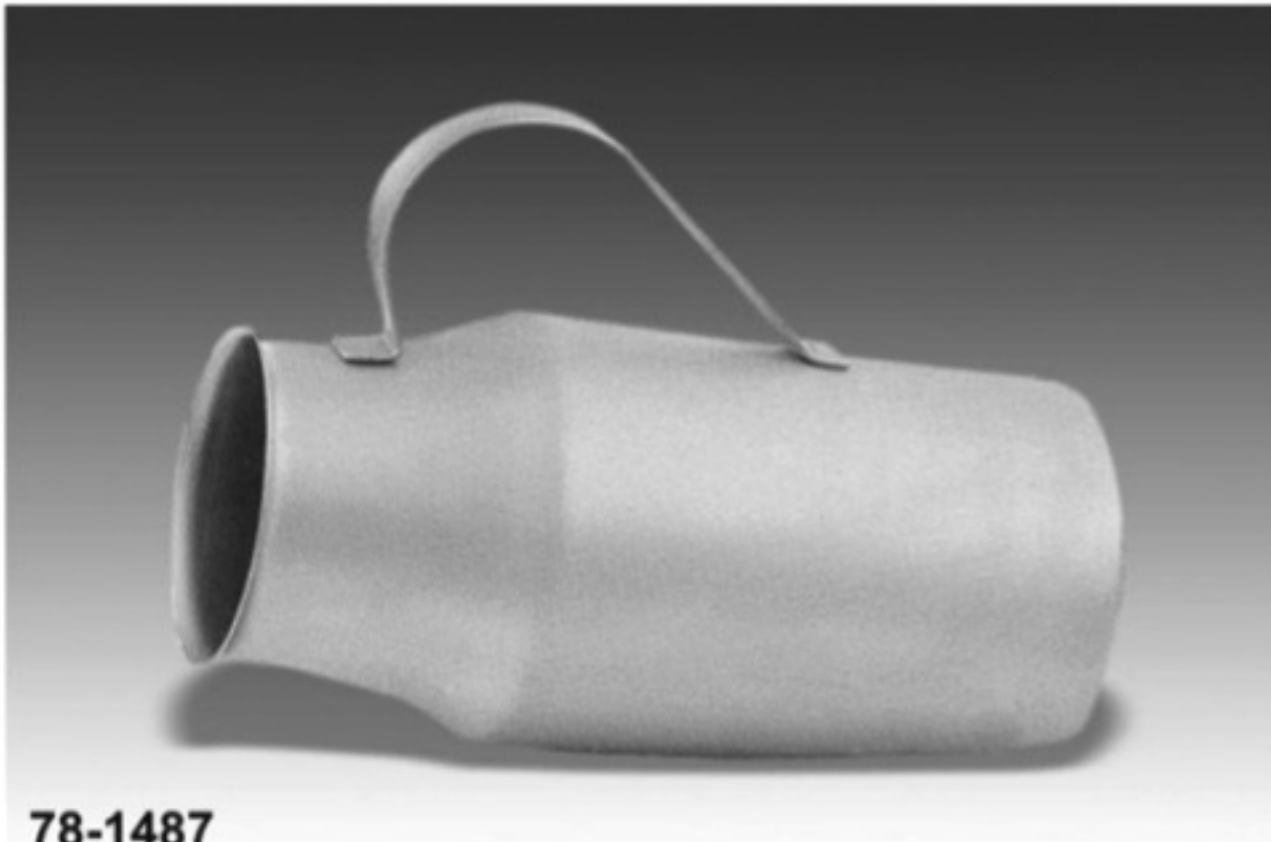

**78-1487
HORIZONTAL URINAL**

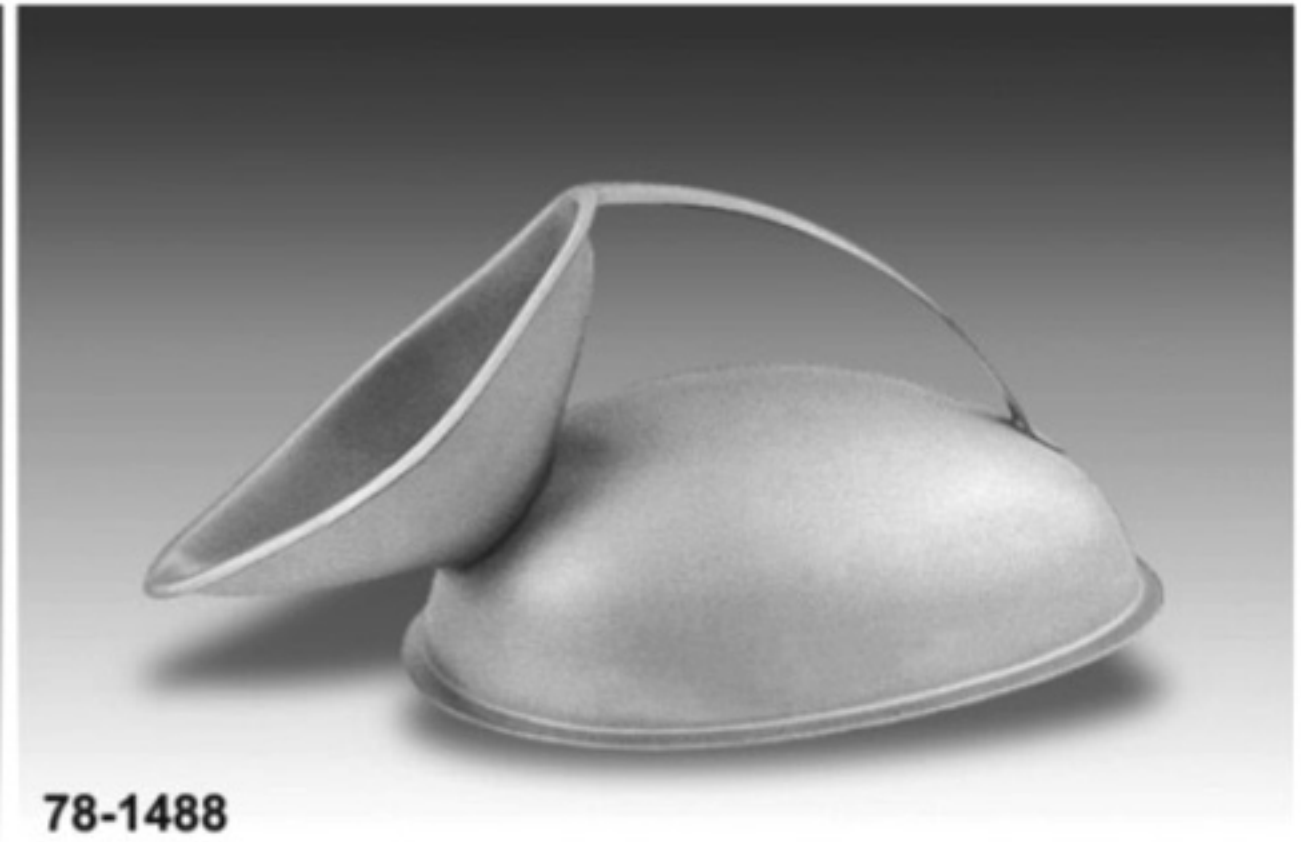

**78-1488
URINAL FEMALE**

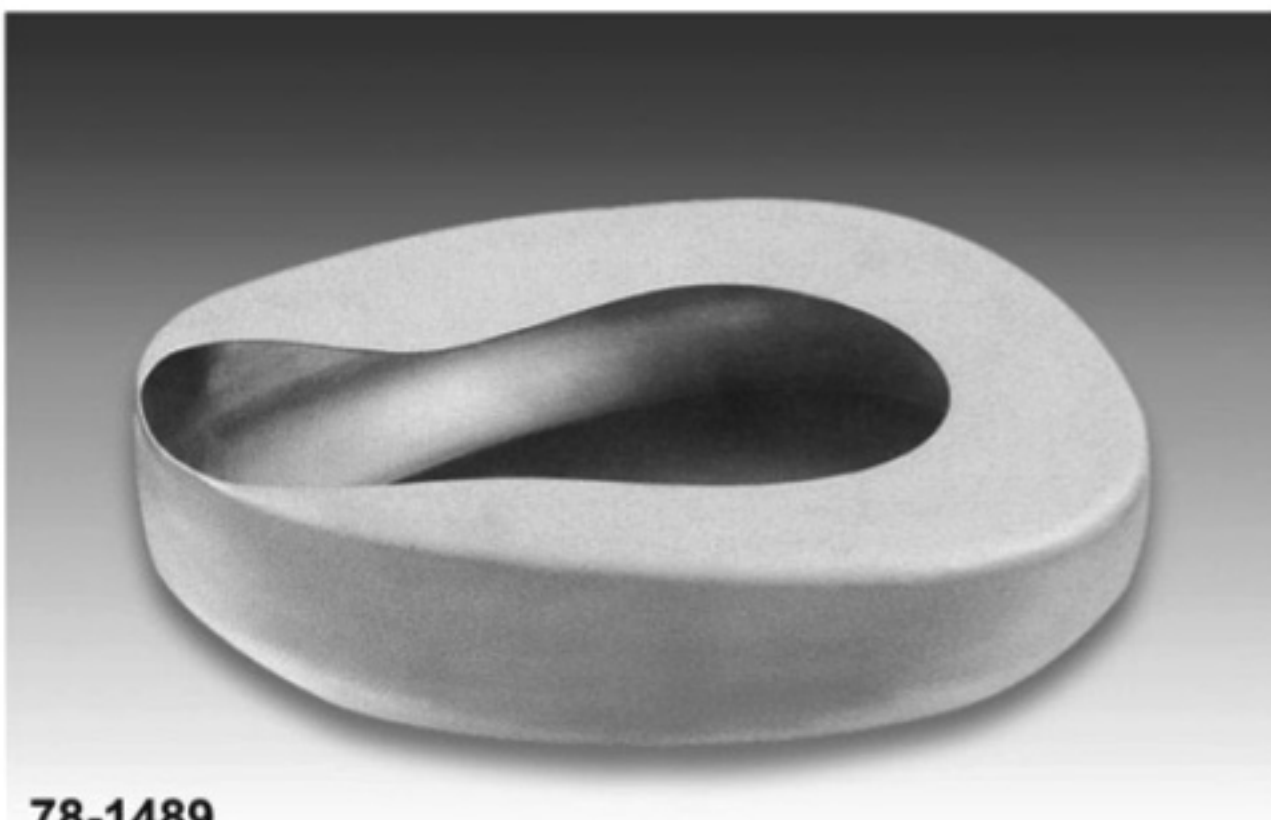

**78-1489
PERFECTION BEDPAN**

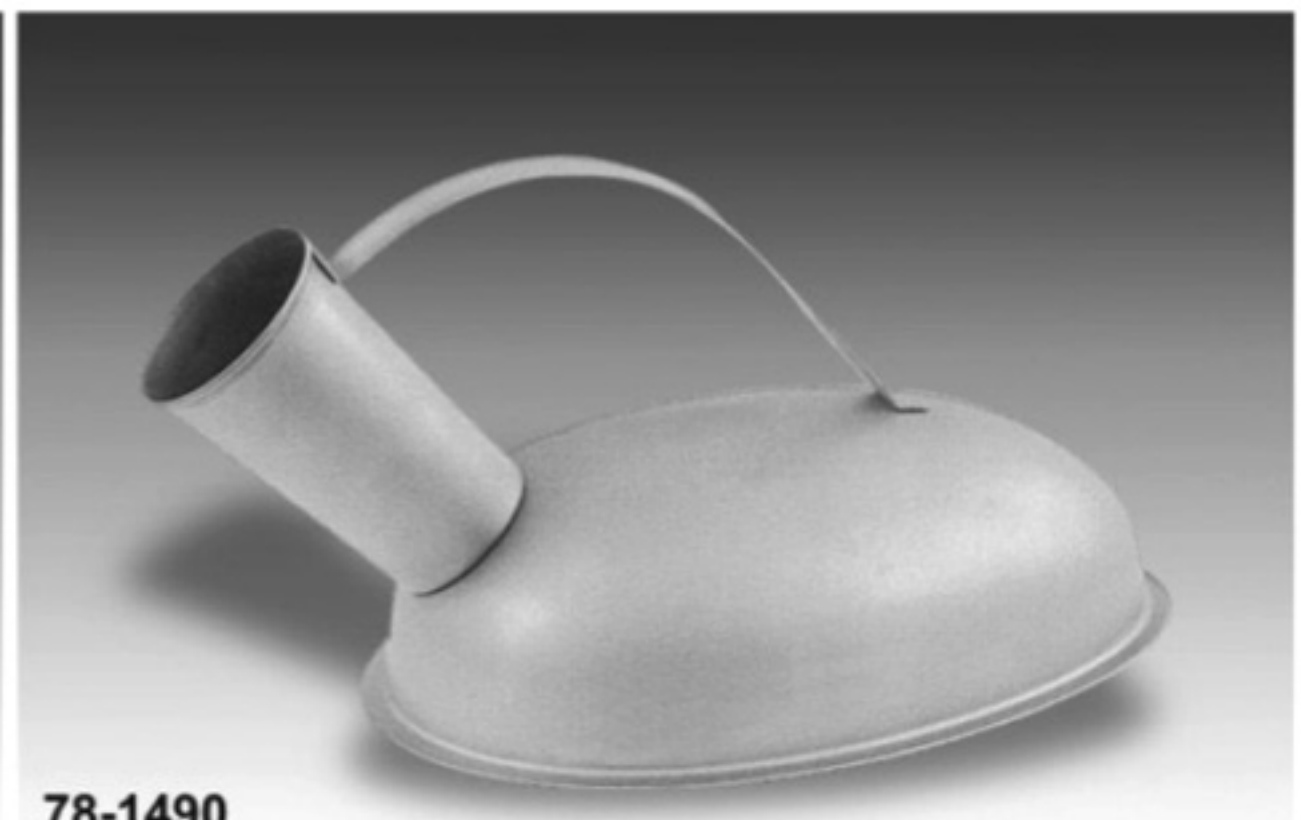

**78-1490
URINAL MALE**



**79-1491
KIDNEY TRAY**



**79-1492
FORCEPS JAR**

**79-1493
THERMOMETER JAR**



**79-1496
FEEDING CUP**

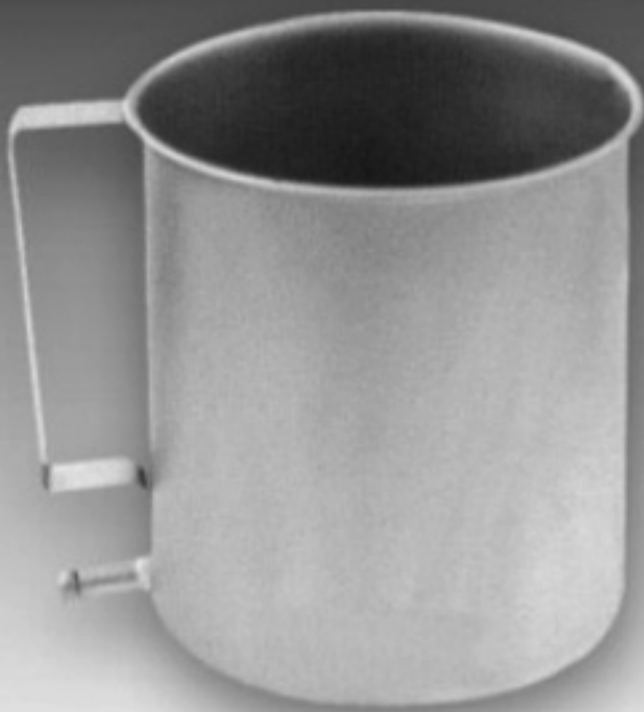

**79-1494
DOUCHE CAN / IRRIGATOR**



**79-1495
MEASURING JUG**



**79-1497
ALCOHAL LAMP**



**79-1498
SPUTUM MUG**

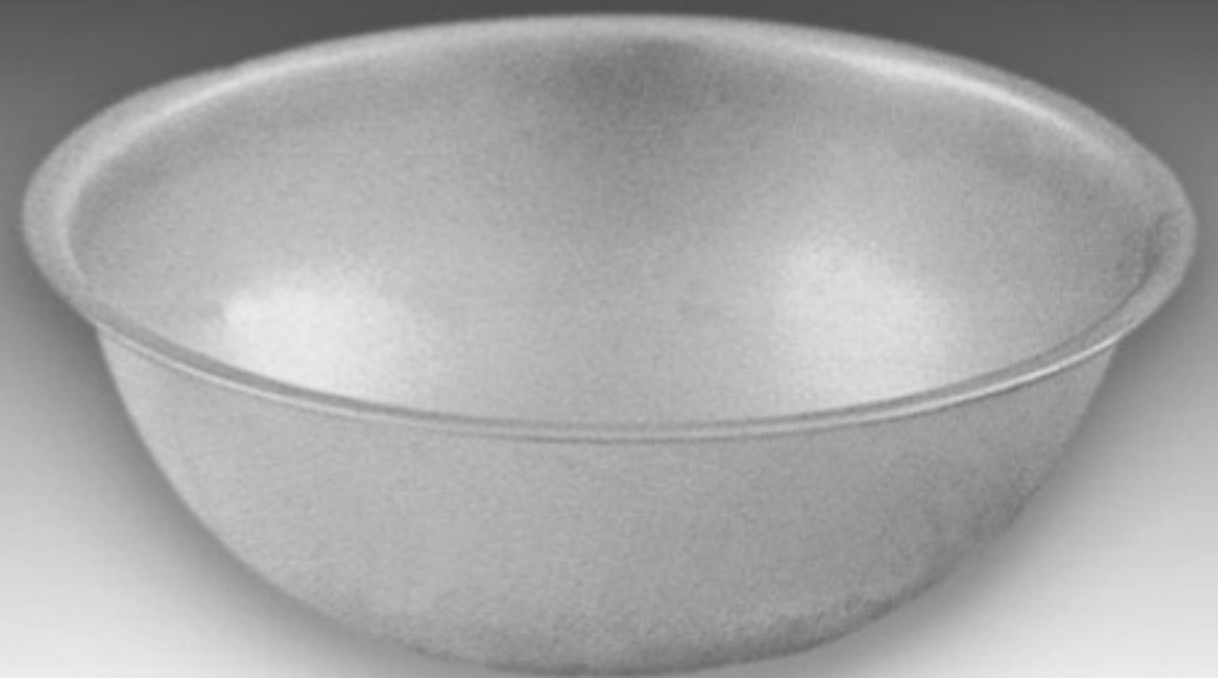

**79-1499
WASH BASIN**

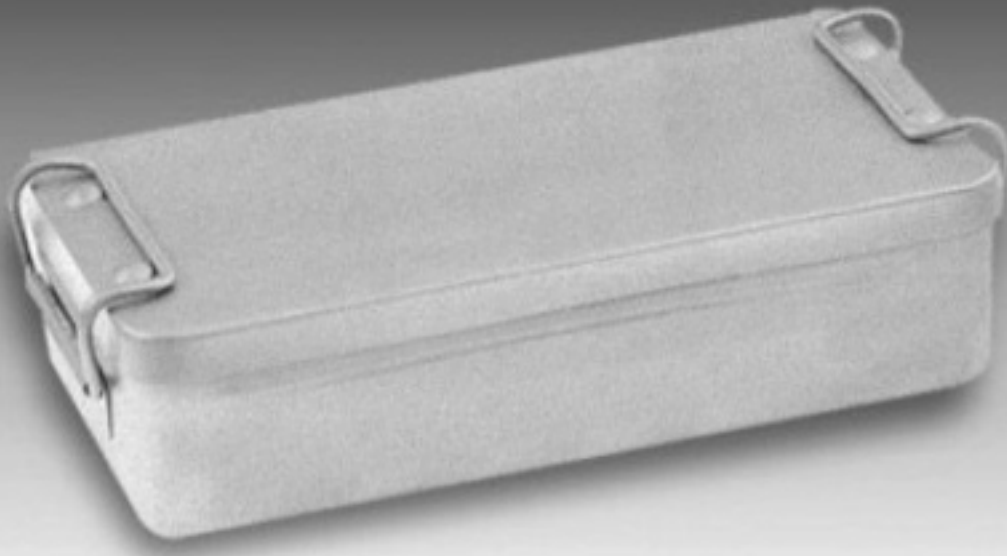

**80-1500
BOX WITH LOCK**

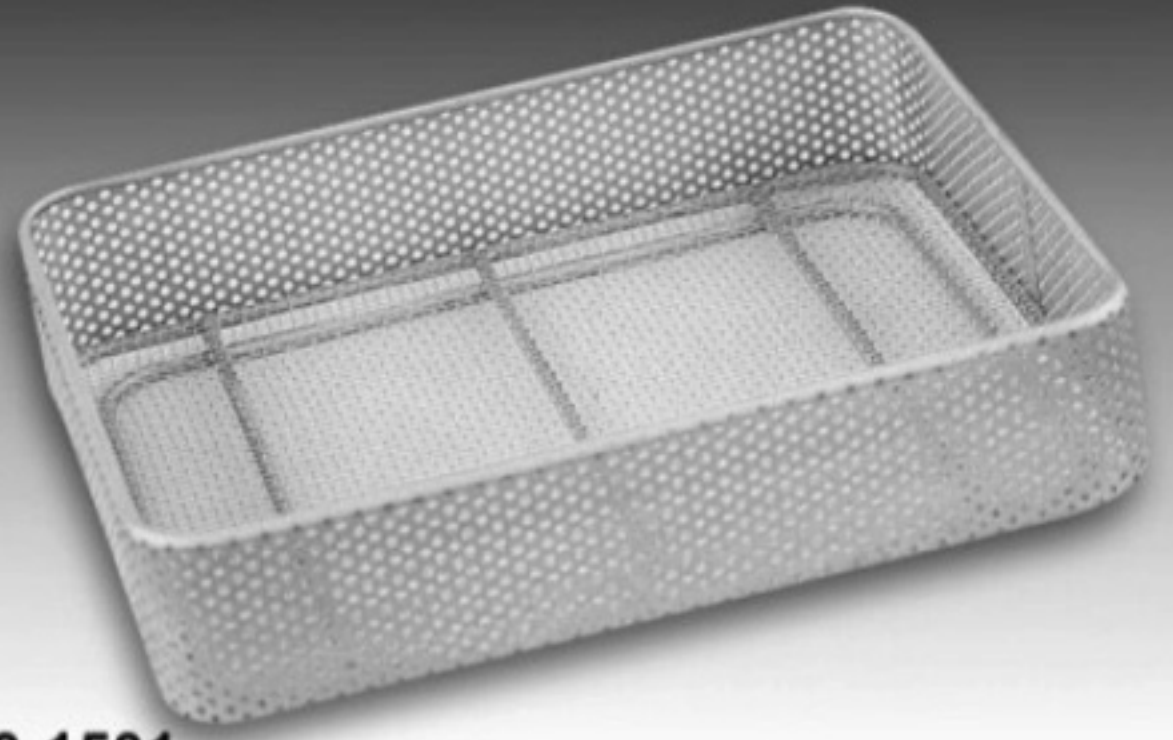

**80-1501
MESH TRAY**

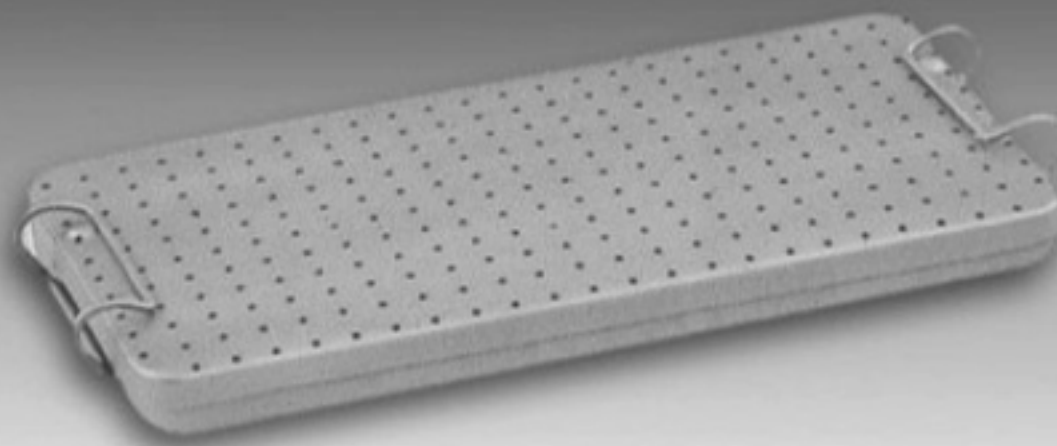

**80-1502
INSTRUMENTS BOX**

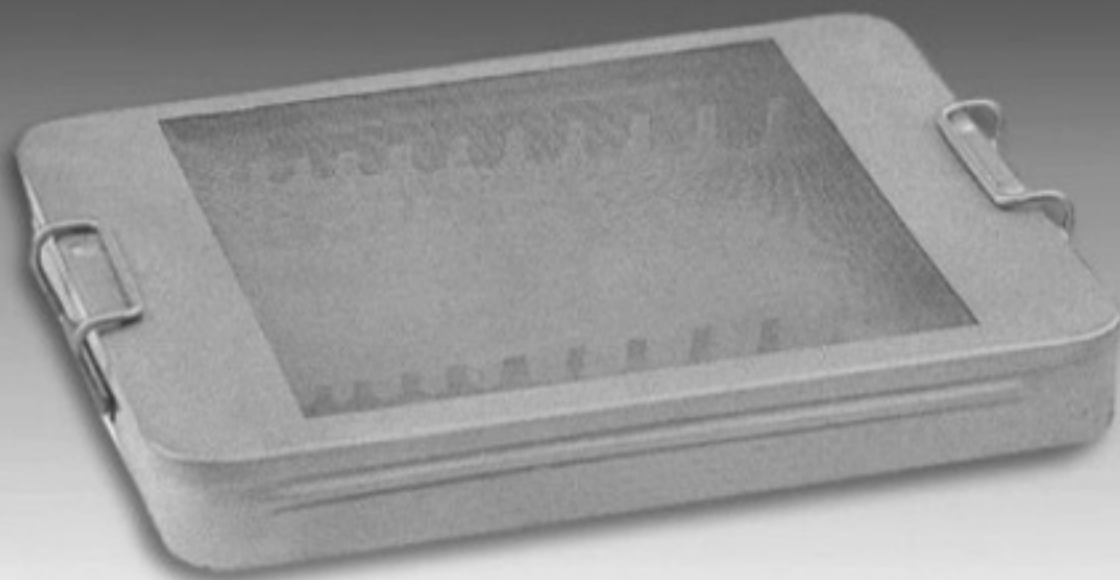

**80-1503
STERILIZER BOX WITH FILTER**

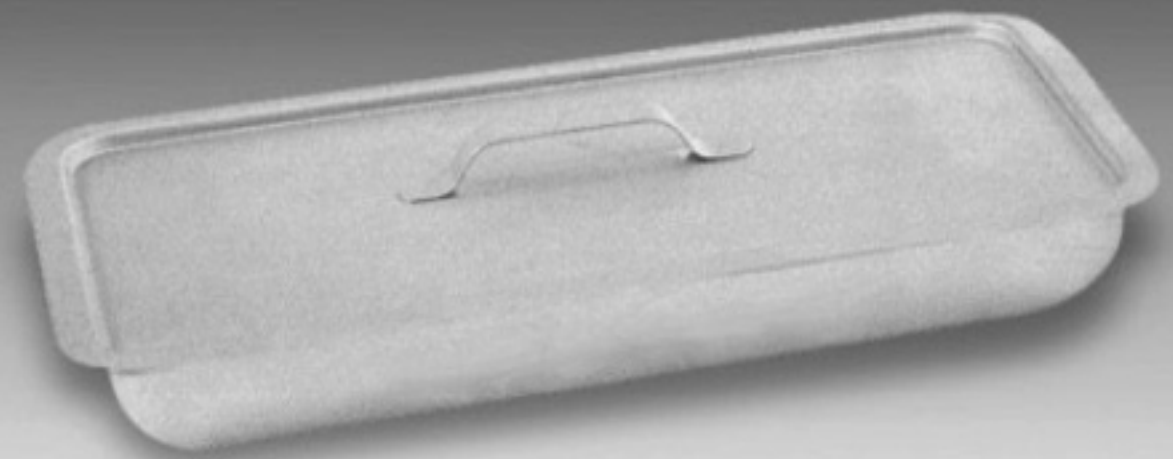

**80-1504
INSTRUMENTS STERILIZING BOX**